

As a matter of proper business decorum, the Board of Directors respectfully request that all cell phones be turned off or placed on vibrate. To prevent any potential distraction of the proceeding, we request that side conversations be taken outside the meeting room.

**AGENDA**  
**REGULAR BOARD MEETING**  
**THREE VALLEYS MUNICIPAL WATER DISTRICT**  
**1021 E. MIRAMAR AVENUE, CLAREMONT, CA 91711**

**Wednesday, November 20, 2019**  
**8:00 a.m.**

*The mission of Three Valleys Municipal Water District is to supplement and enhance local water supplies to meet our region's needs in a reliable and cost-effective manner.*

**Item 1 – Call to Order**

Kuhn

**Item 2 – Pledge of Allegiance**

Kuhn

**Item 3 – Roll Call**

Executive  
Assistant

**Item 4 – Additions to Agenda** [Government Code Section 54954.2(b)(2)]

Kuhn

Additions to the agenda may be considered when two-thirds of the board members present determine a need for immediate action, and the need to act came to the attention of TVMWD after the agenda was posted; this exception requires a degree of urgency. If fewer than two-thirds of the board members are present, all must affirm the action to add an item to the agenda. *The Board shall call for public comment prior to voting to add any item to the agenda after posting.*

**Item 5 – Reorder Agenda**

Kuhn

**Item 6 – Public Comment** (Government Code Section 54954.3)

Kuhn

Opportunity for members of the public to directly address the Board on items of public interest within its jurisdiction. The public may also address the Board on items being considered on this agenda. TVMWD requests that all public speakers complete a speaker's card and provide it to the Executive Assistant.

**We request that remarks be limited to five minutes or less. Pursuant to Government Code Section 54954.3, if speaker is utilizing a translator, the total allotted time will be doubled.**

**Item 7 – Presentations**

Litchfield

Mr. Andy Malone of Wildermuth Environmental, Inc. will provide a presentation on Satellite Mapping Systems.

**Item 8 – Public Hearing – Initial Study and Mitigated Negative Declaration for Miragrand Well, Project No. 58463 – [enc]**

Kuhn

The Board will convene a public hearing to hear testimony and receive comments prior to considering action to adopt the Initial Study and Mitigated Negative Declaration for the Miragrand Well, Project No. 58463. TVMWD has fully complied with the noticing requirements for this Public Hearing.

In accordance with Government Code Section 6061, the Public Hearing was noticed in newspapers of general circulation, *San Gabriel Valley Tribune* and *Inland Valley Daily Bulletin* on November 8, 2019. A copy of the notice is available upon request.

- Staff report to the Board of Directors;
- Open the public hearing;
- Consider public comments and testimony;
- Close the public hearing.

**Item 9 – Adopt Resolution No. 19-11-865 to Approve Initial Study/Mitigated Negative Declaration and CEQA Documentation for the TVMWD Miragrand Groundwater Well, Project No. 58463**

Peralta

Upon conclusion of the public hearing held immediately preceding this action, the Board will consider approval of Resolution No. 19-11-865 to adopt CEQA Mitigated Negative Declaration for the Miragrand Groundwater Well, Project No. 58463.

**Item 9 – Board Action Required – Motion No. 19-11-5248**

**Staff Recommendation: Approve as presented**

**Item 10 – Consent Calendar**

Kuhn

**10.A – Receive, Approve and File Minutes, October 2019 – [enc]**

- October 2, 2019 – Regular Board Meeting
- October 16, 2019 – Regular Board Meeting

**10.B – Receive, Approve and File Financial Reports and Investment Update, October 2019 - [enc]**

- Change in Cash and Cash Equivalents Report
- Consolidated Listing of Investment Portfolio and Investment Report
- YTD District Budget Monthly Status Report
- Warrant List

**10.C – Imported Water Sales, October 2019 – [enc]**

The Board will review the imported water sales report for October 2019.

**10.D – Miramar Operations Report, October 2019 – [enc]**

The Board will review the Miramar Operations report for October 2019.

**10.E – FY 2019-20 First Quarter Reserve Update – [enc]**

The Board will be provided a FY 2019-20 first quarter update of TVMWD's reserve schedule.

**10.F – Approval of Contribution to Pension Trust – [enc]**

The Board will consider approval to disburse \$200,000 to TVMWD's Pension Trust.

**10.G – CY 2020 Meeting Schedule – [enc]**

The Board will receive, approve and file the proposed CY 2020 Meeting Schedule.

**10.H – Approval of Organizational Chart Effective November 20, 2019**

The Board will consider approval of the Organizational Chart effective November 20, 2019.

**Items 10.A – 10.H – Board Action Required – Motion No. 19-11-5249**

Staff recommendation: Approve as presented

**Item 11 – General Manager's Report**

Litchfield

*The Executive Leadership Team will provide brief updates on existing matters under their purview and will be available to respond to any questions thereof.*

**11.A – Approve Director Expense Reports, October 2019 – [enc]**

Kuhn

The Board will consider approval of the October 2019 Director expense reports that include disclosure of per diem requests for meeting attendance and itemization of any expenses incurred by TVMWD.

**Item 11.A – Board Action Required – Motion No. 19-11-5250**

Staff recommendation: Approve as presented

**11.B – Legislative Update, November 2019 – [enc]**

Howie

The Board will be provided a current legislative status update.

**11.C – JPIA Insurance Program Recognition – [enc]**

Howie

The Board will be provided an update on the President's Special Recognition Award received for the insurance programs the District participates in with ACWA/JPIA.

**Item 12 – Directors' / General Manager's Oral Reports**

Litchfield

Directors and the Managers may report on activities for meetings to which they are assigned to serve as the representative or alternate of TVMWD, and on other areas of interest.

### **Item 13 – Closed Session**

#### **13.A – Conference with Real Property Negotiators** (Government Code Section 54956.8)

- Property: 1500 N. College Avenue, Claremont, California [District is considering purchase of a small portion (10,000 sq. ft.) of this parcel]
- District Negotiator: Matthew Litchfield, General Manager
- Negotiating Parties: Rancho Santa Ana Botanic Garden
- Under Negotiation: Price and terms of payment

#### **13.B – Public Employee Performance Evaluation** (Government Code Section 54957)

Title: General Manager

#### **13.C – Threat to Public Services or Facilities** (Government Code Section 54957)

- Consultation with Matthew H. Litchfield, General Manager and Robert Peng, Information Technology Manager

#### **13.D – Conference with Legal Counsel – Existing Litigation** [Government Code Section 54956.9(d)(1)]

Name of Case: San Diego County Water Authority v. Metropolitan Water District of Southern California, et al., San Francisco County Superior Court Case No. CPF-10-510830 (Consolidated with Case No. CPF-12-512466)

### **Item 14 – Future Agenda Items**

Kuhn

### **Item 15 – Adjournment and Next Meeting**

Kuhn

The Board will adjourn to a Regular Board Meeting on Wednesday, December 18, 2019 at 8:00 a.m.

**Note: During the October 16, 2019 meeting the Board acted to cancel the December 4, 2019 regular meeting.**

## **American Disabilities Act Compliance Statement**

*Government Code Section 54954.2(a)*



*Any request for disability-related modifications or accommodations (including auxiliary aids or services) sought to participate in the above public meeting should be directed to the TVMWD's Executive Assistant at (909) 621-5568 at least 24 hours prior to meeting.*

### **Agenda items received after posting**

*Government Code Section 54957.5*

*Materials related to an item on this agenda submitted after distribution of the agenda packet are available for public review at the TVMWD office located at, 1021 East Miramar Avenue, Claremont, CA, 91711. The materials will also be posted on the TVMWD website at [www.threevalleys.com](http://www.threevalleys.com).*

*Three Valleys MWD Board Meeting packets and agendas are available for review on its website at [www.threevalleys.com](http://www.threevalleys.com).*



**Board of Directors  
Staff Report**

**To:** TVMWD Board of Directors  
**From:** Matthew H. Litchfield, General Manager   
**Date:** November 20, 2019  
**Subject:** **Public Hearing – Initial Study and Mitigated Negative Declaration for Grand Avenue Well, Project No. 58463**

---

<input type="checkbox"/> <b>For Action</b>	<input type="checkbox"/> <b>Fiscal Impact</b>	<input type="checkbox"/> <b>Funds Budgeted</b>
<input checked="" type="checkbox"/> <b>Information Only</b>	<input type="checkbox"/> <b>Cost Estimate:</b>	<b>\$</b>

---

**Staff Recommendation:**

**Staff is recommending board conduct the Public Hearing.**

**Discussion:**

The Board will convene a public hearing on the above-referenced matter relating to the Initial Study and Mitigated Negative Declaration for TVMWD’s Miragrand Well, Project No. 58463.

The Board will receive a staff report and be available to hear any testimony in this matter. After testimony is provided, the Board may elect to continue the public hearing to a later date or close the public hearing to enter a decision.

All materials related to this item have been assembled as part of the California Environmental Quality Act (CEQA) adoption for the above-referenced project. Agenda Item 9 provides for that adoption after the close of the public hearing.

**Strategic Plan Objective(s):**

3.3 – Be accountable and transparent with major decisions

**Attachment(s):**

Exhibit A – Proof of Publication: Notice of Availability (NOA) and Notice of Intent (NOI) to Adopt Initial Study/Mitigated Negative Declaration (IS/MND) – Inland Valley Daily Bulletin and San Gabriel Valley Tribune.

Exhibit B – Proof of Publication: Notice of Public Hearing to Adopt Initial Study/Mitigated Negative Declaration (IS/MND) - Inland Valley Daily Bulletin and San Gabriel Valley Tribune.

**Meeting History:**

November 6, 2019

September 4, 2019

NA/ML

**Inland Valley Daily Bulletin**

(formerly the Progress Bulletin)  
9616 Archibald Avenue Suite 100  
Rancho Cucamonga, CA 91730  
909-987-6397  
legals@inlandnewspapers.com

Item 8 - Exhibit A

THREE VALLEY WATER DIST-LEGAL  
1021 MIRAMAR AVENUE  
CLAREMONT, CA 91711

.....

*Account Number:* 5038501

*Ad Order Number:* 0011317808

*Customer's Reference*  
*/ PO Number:*

*Publication:* Inland Valley Daily Bulletin

*Publication Dates:* 09/27/2019

*Amount:* \$620.60

*Payment Amount:* \$0.00



In accordance with the California Environmental Quality Act (CEQA) and the CEQA Guidelines, notice is hereby given that Three Valleys Municipal Water District is issuing the Draft Initial Study / Mitigated Negative Declaration (IS/MND) for public review and comment that identifies and evaluates the environmental impacts of the below-named project. The IS/MND will be posted and a 30-day public review period will take place. Further, notice is given that a public hearing will be held at a future date on the project as follows:

**Project Title:** TVMWD Miragrand Production Well

**Project Location:** 675 East Miramar Avenue in the City of Claremont, Los Angeles County. A vacant lot on the northwest corner of Miramar Avenue and Grand Avenue.

**Project Description:** Construction of a new groundwater production well to be housed within an approximate 600-square-foot building and associated discharge pipeline to connect the well to the Three Valleys Municipal Water District (TVMWD) Miramar Treatment Plant located at 1021 E. Miramar Avenue. The purpose of the project is for TVMWD to produce approximately 700 to 800 acre-feet per year (AFY) of groundwater for the purpose of increasing local water supplies and improving overall water supply reliability.

**Environmental Review:** The Draft Initial Study and Mitigated Negative Declaration (IS/MND) is available for review and comment at: [www.threevalleys.com](http://www.threevalleys.com) and the following locations:

Three Valleys MWD Office County of Los Angeles Public Library - Claremont  
1021 E. Miramar Avenue 208 N Harvard Ave  
Claremont, CA 91711-2052 Claremont, CA 91711  
Open Mon-Thurs 8 am to 5 pm (Refer to the Library for hours)

Any questions regarding the project may be directed to Ray Evangelista, at (909) 621-5568 ext. 110 or at [revangelista@tvmwd.com](mailto:revangelista@tvmwd.com).

**Public Comment Period:** Interested persons are encouraged to provide written comments on the IS/MND. The public review period begins on **Friday, September 27, 2019**. Comments on the Draft IS/MND must be submitted by **Monday, October 28, 2019 at 5:00 PM**. Interested persons may provide comments on the IS/MND by writing to Ray Evangelista, TVMWD, 1021 E. Miramar Ave., Claremont, CA 91711 2052, or via email to [revangelista@tvmwd.com](mailto:revangelista@tvmwd.com). Failure to file objections to the IS/MND during the public review period above may constitute a waiver of rights to object to the environmental determination at a later date.

**Public Hearing:** A public hearing to consider adoption of the IS/MND will be on **Wednesday November 20, 2019 at 8:00AM**. A separate notice regarding that hearing will be distributed in advance of that hearing date. All interested persons are invited to appear and be heard. The project site is not included on a list of sites compiled pursuant to Government Code section 65962.5 regarding hazardous waste. Pursuant to Government Code Section 54954.2(a), any request for disability-related modification or accommodation (including auxiliary aids or services) that is sought in order to participate in the future agendized public meeting should be directed to the District's Executive Assistant at (909) 621-5568 at least 24 hours prior to said meeting. **Para información en Español, llame (909) 621-5568.**

Publication date: September 27, 2019  
**Inland Valley Daily Bulletin-LA Ad#11317808**

**Inland Valley Daily Bulletin**

(formerly the Progress Bulletin)  
9616 Archibald Avenue Suite 100  
Rancho Cucamonga, CA 91730  
909-987-6397  
legals@inlandnewspapers.com

5038501

THREE VALLEY WATER DIST-LEGAL  
1021 MIRAMAR AVENUE  
CLAREMONT, CA 91711

**PROOF OF PUBLICATION  
(2015.5 C.C.P.)**

**STATE OF CALIFORNIA  
County of Los Angeles**

I am a citizen of the United States, I am over the age of eighteen years, and not a party to or interested in the above-entitled matter. I am the principal clerk of the printer of INLAND VALLEY DAILY BULLETIN, a newspaper of general circulation printed and published daily for the City of Pomona, County of Los Angeles, and which newspaper has been adjudged a newspaper of general circulation by the Superior Court of the County of Los Angeles, State of California, on the date of June 15, 1945, Decree No. Pomo C-606. The notice, of which the annexed is a true printed copy, has been published in each regular and entire issue of said newspaper and not in any supplement thereof on the following dates, to wit:

**09/27/2019**

I declare under the penalty of perjury that the foregoing is true and correct.

Executed at Rancho Cucamonga, San Bernardino Co., California, on this 27th day of September, 2019.



Signature

(Space below for use of County Clerk Only)

**Item 8 - Exhibit A**

Legal No. **0011317808**

**NOTICE OF AVAILABILITY (NOA) AND NOTICE OF INTENT (NOI) TO ADOPT AN INITIAL STUDY / MITIGATED NEGATIVE DECLARATION**

In accordance with the California Environmental Quality Act (CEQA) and the CEQA Guidelines, notice is hereby given that Three Valleys Municipal Water District is issuing the Draft Initial Study / Mitigated Negative Declaration (IS/MND) for public review and comment that identifies and evaluates the environmental impacts of the below-named project. The IS/MND will be posted and a 30-day public review period will take place. Further, notice is given that a public hearing will be held at a future date on the project as follows:

**Project Title:** TVMWD Miragrand Production Well

**Project Location:** 675 East Miramar Avenue in the City of Claremont, Los Angeles County. A vacant lot on the northwest corner of Miramar Avenue and Grand Avenue.

**Project Description:** Construction of a new groundwater production well to be housed within an approximate 600-square-foot building and associated discharge pipeline to connect the well to the Three Valleys Municipal Water District (TVMWD) Miramar Treatment Plant located at 1021 E. Miramar Avenue. The purpose of the project is for TVMWD to produce approximately 700 to 800 acre-feet per year (AFY) of groundwater for the purpose of increasing local water supplies and improving overall water supply reliability.

**Environmental Review:** The Draft Initial Study and Mitigated Negative Declaration (IS/MND) is available for review and comment at: [www.threevalleys.com](http://www.threevalleys.com) and the following locations:

Three Valleys MWD Office  
1021 E. Miramar Avenue  
Claremont, CA 91711-2052  
Open Mon-Thurs 8 am to 5 pm

County of Los Angeles Public Library - Claremont  
208 N Harvard Ave  
Claremont, CA 91711  
(Refer to the Library for hours)

Any questions regarding the project may be directed to Ray Evangelista, at (909) 621-5568 ext. 110 or at [revangelista@tvmwd.com](mailto:revangelista@tvmwd.com).

**Public Comment Period:** Interested persons are encouraged to provide written comments on the IS/MND. The public review period begins on **Friday, September 27, 2019**. Comments on the Draft IS/MND must be submitted by **Monday, October 28, 2019 at 5:00 PM**. Interested persons may provide comments on the IS/MND by writing to Ray Evangelista, TVMWD, 1021 E. Miramar Ave., Claremont, CA 91711 2052, or via email to [revangelista@tvmwd.com](mailto:revangelista@tvmwd.com). Failure to file objections to the IS/MND during the public review period above may constitute a waiver of rights to object to the environmental determination at a later date.

**Public Hearing:** A public hearing to consider adoption of the IS/MND will be on **Wednesday November 20, 2019 at 8:00AM**. A separate notice regarding that hearing will be distributed in advance of that hearing date. All interested persons are invited to appear and be heard. The project site is not included on a list of sites compiled pursuant to Government Code section 65962.5 regarding hazardous waste. Pursuant to Government Code Section 54954.2(a), any request for disability-related modification or accommodation (including auxiliary aids or services) that is sought in order to participate in the future agenda public meeting should be directed to the District's Executive Assistant at (909) 621-5568 at least 24 hours prior to said meeting. **Para información en Español, llame (909) 621-5568.**

Publication date: September 27, 2019  
**Inland Valley Daily Bulletin-LA**

**Ad#11317808**

**San Gabriel Valley Tribune**

Affiliated with SGV Newspaper Group  
605 E. Huntington Dr., Suite 100  
Monrovia, CA 91016  
626-962-8811 ext. 40891

Item 8 - Exhibit A

THREE VALLEYS MUNICIPAL WATER  
1021 E. MIRIMAR AVE.  
CLAREMONT, CA 91711-1300

.....  
*Account Number:* 5038502

*Ad Order Number:* 0011317797

*Customer's Reference*  
*/ PO Number:*

*Publication:* San Gabriel Valley Tribune

*Publication Dates:* 09/27/2019

*Amount:* \$605.00

*Payment Amount:* \$0.00

In accordance with the California Environmental Quality Act (CEQA) and the CEQA Guidelines, notice is hereby given that Three Valleys Municipal Water District is issuing the Draft Initial Study / Mitigated Negative Declaration (IS/MND) for public review and comment that identifies and evaluates the environmental impacts of the below-named project. The IS/MND will be posted and a 30-day public review period will take place. Further, notice is given that a public hearing will be held at a future date on the project as follows:

**Project Title:** TVMWD Miragrand Production Well

**Project Location:** 675 East Miramar Avenue in the City of Claremont, Los Angeles County. A vacant lot on the northwest corner of Miramar Avenue and Grand Avenue.

**Project Description:** Construction of a new groundwater production well to be housed within an approximate 600-square-foot building and associated discharge pipeline to connect the well to the Three Valleys Municipal Water District (TVMWD) Miramar Treatment Plant located at 1021 E. Miramar Avenue. The purpose of the project is for TVMWD to produce approximately 700 to 800 acre-feet per year (AFY) of groundwater for the purpose of increasing local water supplies and improving overall water supply reliability.

**Environmental Review:** The Draft Initial Study and Mitigated Negative Declaration (IS/MND) is available for review and comment at: [www.threevalleys.com](http://www.threevalleys.com) and the following locations:

Three Valleys MWD Office County of Los Angeles Public Library - Claremont  
1021 E. Miramar Avenue 208 N Harvard Ave  
Claremont, CA 91711-2052 Claremont, CA 91711  
Open Mon-Thurs 8 am to 5 pm (Refer to the Library for hours)

Any questions regarding the project may be directed to Ray Evangelista, at (909) 621-5568 ext. 110 or at [revangelista@tvmwd.com](mailto:revangelista@tvmwd.com).

**Public Comment Period:** Interested persons are encouraged to provide written comments on the IS/MND. The public review period begins on **Friday, September 27, 2019**. Comments on the Draft IS/MND must be submitted by **Monday, October 28, 2019 at 5:00 PM**. Interested persons may provide comments on the IS/MND by writing to Ray Evangelista, TVMWD, 1021 E. Miramar Ave., Claremont, CA 91711 2052, or via email to [revangelista@tvmwd.com](mailto:revangelista@tvmwd.com). Failure to file objections to the IS/MND during the public review period above may constitute a waiver of rights to object to the environmental determination at a later date.

**Public Hearing:** A public hearing to consider adoption of the IS/MND will be on **Wednesday November 20, 2019 at 8:00AM**. A separate notice regarding that hearing will be distributed in advance of that hearing date. All interested persons are invited to appear and be heard. The project site is not included on a list of sites compiled pursuant to Government Code section 65962.5 regarding hazardous waste. Pursuant to Government Code Section 54954.2(a), any request for disability-related modification or accommodation (including auxiliary aids or services) that is sought in order to participate in the future agendized public meeting should be directed to the District's Executive Assistant at (909) 621-5568 at least 24 hours prior to said meeting. **Para información en Español, llame (909) 621-5568.**

Publication date: September 27, 2019  
**San Gabriel Valley Tribune Ad#11317797**

**San Gabriel Valley Tribune**

Affiliated with SGV Newspaper Group  
605 E. Huntington Dr., Suite 100  
Monrovia, CA 91016  
626-962-8811 ext. 40891

5038502

THREE VALLEYS MUNICIPAL WATER  
1021 E. MIRIMAR AVE.  
CLAREMONT, CA 91711-1300

**PROOF OF PUBLICATION  
(2015.5 C.C.P.)**

**STATE OF CALIFORNIA  
County of Los Angeles**

I am a citizen of the United States, and a resident of the county aforesaid. I am over the age of eighteen years and not a party to or interested in the above-entitled matter. I am the principal clerk of the printer of SAN GABRIEL VALLEY TRIBUNE, a newspaper of general circulation for the City of West Covina, by the Superior Court of the County of Los Angeles, State of California, on the date of September 10, 1957, Case Number 684891. The notice, of which the annexed is a true printed copy, has been published in each regular and entire issue of said newspaper and not in any supplement thereof on the following dates, to wit:

**09/27/2019**

I declare under the penalty of perjury that the foregoing is true and correct.

Executed at Monrovia, LA Co. California  
On this 27th day of September, 2019.



Signature

(Space below for use of County Clerk Only)

**Item 8 - Exhibit A**

Legal No. **0011317797**

**NOTICE OF AVAILABILITY (NOA) AND NOTICE OF INTENT (NOI) TO ADOPT AN INITIAL STUDY / MITIGATED NEGATIVE DECLARATION**

In accordance with the California Environmental Quality Act (CEQA) and the CEQA Guidelines, notice is hereby given that Three Valleys Municipal Water District is issuing the Draft Initial Study / Mitigated Negative Declaration (IS/MND) for public review and comment that identifies and evaluates the environmental impacts of the below-named project. The IS/MND will be posted and a 30-day public review period will take place. Further, notice is given that a public hearing will be held at a future date on the project as follows:

**Project Title:** TVMWD Miragrand Production Well

**Project Location:** 675 East Miramar Avenue in the City of Claremont, Los Angeles County. A vacant lot on the northwest corner of Miramar Avenue and Grand Avenue.

**Project Description:** Construction of a new groundwater production well to be housed within an approximate 600-square-foot building and associated discharge pipeline to connect the well to the Three Valleys Municipal Water District (TVMWD) Miramar Treatment Plant located at 1021 E. Miramar Avenue. The purpose of the project is for TVMWD to produce approximately 700 to 800 acre-feet per year (AFY) of groundwater for the purpose of increasing local water supplies and improving overall water supply reliability.

**Environmental Review:** The Draft Initial Study and Mitigated Negative Declaration (IS/MND) is available for review and comment at: [www.threevalleys.com](http://www.threevalleys.com) and the following locations:

Three Valleys MWD Office 1021 E. Miramar Avenue Claremont, CA 91711-2052 Open Mon-Thurs 8 am to 5 pm	County of Los Angeles Public Library - Claremont 208 N Harvard Ave Claremont, CA 91711 (Refer to the Library for hours)
---	--

Any questions regarding the project may be directed to Ray Evangelista, at (909) 621-5568 ext. 110 or at [revangelista@tvmwd.com](mailto:revangelista@tvmwd.com).

**Public Comment Period:** Interested persons are encouraged to provide written comments on the IS/MND. The public review period begins on **Friday, September 27, 2019**. Comments on the Draft IS/MND must be submitted by **Monday, October 28, 2019 at 5:00 PM**. Interested persons may provide comments on the IS/MND by writing to Ray Evangelista, TVMWD, 1021 E. Miramar Ave., Claremont, CA 91711 2052, or via email to [revangelista@tvmwd.com](mailto:revangelista@tvmwd.com). Failure to file objections to the IS/MND during the public review period above may constitute a waiver of rights to object to the environmental determination at a later date.

**Public Hearing:** A public hearing to consider adoption of the IS/MND will be on **Wednesday November 20, 2019 at 8:00AM**. A separate notice regarding that hearing will be distributed in advance of that hearing date. All interested persons are invited to appear and be heard. The project site is not included on a list of sites compiled pursuant to Government Code section 65962.5 regarding hazardous waste. Pursuant to Government Code Section 54954.2(a), any request for disability-related modification or accommodation (including auxiliary aids or services) that is sought in order to participate in the future agenda public meeting should be directed to the District's Executive Assistant at (909) 621-5568 at least 24 hours prior to said meeting. **Para información en Español, llame (909) 621-5568.**

Publication date: September 27, 2019  
San Gabriel Valley Tribune

Ad#11317797

**Inland Valley Daily Bulletin**

(formerly the Progress Bulletin)  
9616 Archibald Avenue Suite 100  
Rancho Cucamonga, CA 91730  
909-987-6397  
legals@inlandnewspapers.com

Item 8 - Exhibit B

THREE VALLEY WATER DIST-LEGAL  
1021 MIRAMAR AVENUE  
CLAREMONT, CA 91711

.....

*Account Number:* 5038501

*Ad Order Number:* 0011332477

*Customer's Reference*  
*/ PO Number:*

*Publication:* Inland Valley Daily Bulletin

*Publication Dates:* 11/08/2019

*Amount:* \$628.30

*Payment Amount:* \$0.00



**NOTICE IS HEREBY GIVEN**, pursuant to the California Environmental Quality Act (CEQA), that Three Valleys Municipal Water District (TVMWD) plans to improve operational flexibility of the water system and improve the reliability of regional water supplies. The project includes the construction (drilling and equipping) of a groundwater production well. The following hearing has been scheduled for the project:

TVMWD will consider the Draft Initial Study and Mitigated Negative Declaration (IS/MND), on **Wednesday, November 20, 2019 at 8:00 AM** in the **Three Valleys MWD Administrative Office at 1021 East Miramar Avenue**, Claremont. All interested persons are invited to appear and be heard.

Project Description

The proposed project is on TVMWD property located 675 East Miramar Avenue, in the city of Claremont. The main components of the project include construction (drilling and equipping) of a groundwater production well, well casing/louvers, a well enclosure, and water piping. All construction will take place on the property and within the street ROW for construction of the well, well enclosure, and approximately 300 linear feet of water pipe connecting the well to the TVMWD Miramar Plant located at 1021 E. Miramar Avenue in Claremont.

**ENVIRONMENTAL DETERMINATION**

NOTICE IS FURTHER GIVEN that TVMWD has completed an Initial Study of the project in accordance with the State's guidelines for implementing CEQA. Staff has concluded that there will be no significant negative impact on the environment, and therefore, a Draft Mitigated Negative Declaration has been prepared. The public review period for the Initial Study and Draft Mitigated Negative Declaration (IS/MND) began on September 27, 2019 and concluded on October 28, 2019.

Copies of the IS/MND were available during the public review period on the TVMWD website ([www.threevalleys.com](http://www.threevalleys.com)), at TVMWD's office located at 1021 E. Miramar Avenue, Claremont, as well as the Claremont Public Library. TVMWD is open Monday through Thursday 8:00 AM to 5:00 PM.

Failure to file objections to the IS/MND during the public review period or at the public hearing referenced above may constitute a waiver of rights to object to the environmental determination later.

Finally, pursuant to Government Code Section 54954.2(a), any request for disability-related modification or accommodation (including auxiliary aids or services) that is sought to participate in the above-agendized public meeting should be directed to the District's Executive Assistant at (909) 621-5568 at least 24 hours prior to said meeting.

**Para información en Español, llame (909) 621-5568**

Published: November 8, 2019

---

/s/ Matthew H. Litchfield  
General Manager / Chief Engineer  
THREE VALLEYS MWD  
**Inland Valley Daily Bulletin-LA Ad#11332477**

**Inland Valley Daily Bulletin**

(formerly the Progress Bulletin)  
9616 Archibald Avenue Suite 100  
Rancho Cucamonga, CA 91730  
909-987-6397  
legals@inlandnewspapers.com

5038501

THREE VALLEY WATER DIST-LEGAL  
1021 MIRAMAR AVENUE  
CLAREMONT, CA 91711

**PROOF OF PUBLICATION  
(2015.5 C.C.P.)**

**STATE OF CALIFORNIA  
County of Los Angeles**

I am a citizen of the United States, I am over the age of eighteen years, and not a party to or interested in the above-entitled matter. I am the principal clerk of the printer of INLAND VALLEY DAILY BULLETIN, a newspaper of general circulation printed and published daily for the City of Pomona, County of Los Angeles, and which newspaper has been adjudged a newspaper of general circulation by the Superior Court of the County of Los Angeles, State of California, on the date of June 15, 1945, Decree No. Pomo C-606. The notice, of which the annexed is a true printed copy, has been published in each regular and entire issue of said newspaper and not in any supplement thereof on the following dates, to wit:

**11/08/2019**

I declare under the penalty of perjury that the foregoing is true and correct.

Executed at Rancho Cucamonga, San Bernardino Co., California, on this 8th day of November, 2019.



Signature

(Space below for use of County Clerk Only)

**Item 8 - Exhibit B**

Legal No. **0011332477**

**NOTICE OF PUBLIC HEARING  
THREE VALLEYS MUNICIPAL WATER DISTRICT  
ADOPT INITIAL STUDY - MITIGATED NEGATIVE DECLARATION  
PROJECT NO. 58463 – TVMWD MIRAGRAND WELL**

**NOTICE IS HEREBY GIVEN**, pursuant to the California Environmental Quality Act (CEQA), that Three Valleys Municipal Water District (TVMWD) plans to improve operational flexibility of the water system and improve the reliability of regional water supplies. The project includes the construction (drilling and equipping) of a groundwater production well. The following hearing has been scheduled for the project:

- TVMWD will consider the Draft Initial Study and Mitigated Negative Declaration (IS/MND), on **Wednesday, November 20, 2019 at 8:00 AM** in the **Three Valleys MWD Administrative Office at 1021 East Miramar Avenue**, Claremont. All interested persons are invited to appear and be heard.

**Project Description**

The proposed project is on TVMWD property located 675 East Miramar Avenue, in the city of Claremont. The main components of the project include construction (drilling and equipping) of a groundwater production well, well casing/louvers, a well enclosure, and water piping. All construction will take place on the property and within the street ROW for construction of the well, well enclosure, and approximately 300 linear feet of water pipe connecting the well to the TVMWD Miramar Plant located at 1021 E. Miramar Avenue in Claremont.

**ENVIRONMENTAL DETERMINATION**

NOTICE IS FURTHER GIVEN that TVMWD has completed an Initial Study of the project in accordance with the State’s guidelines for implementing CEQA. Staff has concluded that there will be no significant negative impact on the environment, and therefore, a Draft Mitigated Negative Declaration has been prepared. The public review period for the Initial Study and Draft Mitigated Negative Declaration (IS/MND) began on September 27, 2019 and concluded on October 28, 2019.

Copies of the IS/MND were available during the public review period on the TVMWD website ([www.threevalleys.com](http://www.threevalleys.com)), at TVMWD’s office located at 1021 E. Miramar Avenue, Claremont, as well as the Claremont Public Library. TVMWD is open Monday through Thursday 8:00 AM to 5:00 PM.

Failure to file objections to the IS/MND during the public review period or at the public hearing referenced above may constitute a waiver of rights to object to the environmental determination later.

Finally, pursuant to Government Code Section 54954.2(a), any request for disability-related modification or accommodation (including auxiliary aids or services) that is sought to participate in the above-agendized public meeting should be directed to the District’s Executive Assistant at (909) 621-5568 at least 24 hours prior to said meeting.

**Para información en Español, llame (909) 621-5568**

Published: November 8, 2019

\_\_\_\_\_  
/s/ Matthew H. Litchfield  
General Manager / Chief Engineer  
THREE VALLEYS MWD  
Ad#11332477

**Inland Valley Daily Bulletin-LA**

**San Gabriel Valley Tribune**

Affiliated with SGV Newspaper Group  
605 E. Huntington Dr., Suite 100  
Monrovia, CA 91016  
626-962-8811 ext. 40891

Item 8 - Exhibit B

THREE VALLEYS MUNICIPAL WATER  
1021 E. MIRIMAR AVE.  
CLAREMONT, CA 91711-1300

.....  
*Account Number:* 5038502

*Ad Order Number:* 0011332463

*Customer's Reference*  
*/ PO Number:*

*Publication:* San Gabriel Valley Tribune

*Publication Dates:* 11/08/2019

*Amount:* \$612.50

*Payment Amount:* \$0.00

**Invoice Text: NOTICE OF PUBLIC HEARING  
THREE VALLEYS MUNICIPAL WATER DISTRICT  
ADOPT INITIAL STUDY - MITIGATED NEGATIVE DECLARATION  
PROJECT NO. 58463 TVMWD MIRAGRAND WELL**

**Item 8 - Exhibit B**

NOTICE IS HEREBY GIVEN, pursuant to the California Environmental Quality Act (CEQA), that Three Valleys Municipal Water District (TVMWD) plans to improve operational flexibility of the water system and improve the reliability of regional water supplies. The project includes the construction (drilling and equipping) of a groundwater production well. The following hearing has been scheduled for the project:

TVMWD will consider the Draft Initial Study and Mitigated Negative Declaration (IS/MND), on **Wednesday, November 20, 2019 at 8:00 AM** in the **Three Valleys MWD Administrative Office at 1021 East Miramar Avenue, Claremont**. All interested persons are invited to appear and be heard.

Project Description

The proposed project is on TVMWD property located 675 East Miramar Avenue, in the city of Claremont. The main components of the project include construction (drilling and equipping) of a groundwater production well, well casing/louvers, a well enclosure, and water piping. All construction will take place on the property and within the street ROW for construction of the well, well enclosure, and approximately 300 linear feet of water pipe connecting the well to the TVMWD Miramar Plant located at 1021 E. Miramar Avenue in Claremont.

**ENVIRONMENTAL DETERMINATION**

NOTICE IS FURTHER GIVEN that TVMWD has completed an Initial Study of the project in accordance with the State's guidelines for implementing CEQA. Staff has concluded that there will be no significant negative impact on the environment, and therefore, a Draft Mitigated Negative Declaration has been prepared. The public review period for the Initial Study and Draft Mitigated Negative Declaration (IS/MND) began on September 27, 2019 and concluded on October 28, 2019.

Copies of the IS/MND were available during the public review period on the TVMWD website ([www.threevalleys.com](http://www.threevalleys.com)), at TVMWD's office located at 1021 E. Miramar Avenue, Claremont, as well as the Claremont Public Library. TVMWD is open Monday through Thursday 8:00 AM to 5:00 PM.

Failure to file objections to the IS/MND during the public review period or at the public hearing referenced above may constitute a waiver of rights to object to the environmental determination later.

Finally, pursuant to Government Code Section 54954.2(a), any request for disability-related modification or accommodation (including auxiliary aids or services) that is sought to participate in the above-agendized public meeting should be directed to the District's Executive Assistant at (909) 621-5568 at least 24 hours prior to said meeting.

**Para información en Español, llame (909) 621-5568**

Published: November 8, 2019

---

/s/ Matthew H. Litchfield  
General Manager / Chief Engineer  
THREE VALLEYS MWD  
**San Gabriel Valley Tribune Ad#11332463**

**San Gabriel Valley Tribune**

Affiliated with SGV Newspaper Group  
605 E. Huntington Dr., Suite 100  
Monrovia, CA 91016  
626-962-8811 ext. 40891

5038502

THREE VALLEYS MUNICIPAL WATER  
1021 E. MIRIMAR AVE.  
CLAREMONT, CA 91711-1300

**PROOF OF PUBLICATION  
(2015.5 C.C.P.)**

**STATE OF CALIFORNIA  
County of Los Angeles**

I am a citizen of the United States, and a resident of the county aforesaid. I am over the age of eighteen years and not a party to or interested in the above-entitled matter. I am the principal clerk of the printer of SAN GABRIEL VALLEY TRIBUNE, a newspaper of general circulation for the City of West Covina, by the Superior Court of the County of Los Angeles, State of California, on the date of September 10, 1957, Case Number 684891. The notice, of which the annexed is a true printed copy, has been published in each regular and entire issue of said newspaper and not in any supplement thereof on the following dates, to wit:

**11/08/2019**

I declare under the penalty of perjury that the foregoing is true and correct.

Executed at Monrovia, LA Co. California  
On this 8th day of November, 2019.



Signature

(Space below for use of County Clerk Only)

**Item 8 - Exhibit B**

Legal No. **0011332463**

**NOTICE OF PUBLIC HEARING  
THREE VALLEYS MUNICIPAL WATER DISTRICT  
ADOPT INITIAL STUDY - MITIGATED NEGATIVE DECLARATION  
PROJECT NO. 58463 – TVMWD MIRAGRAND WELL**

NOTICE IS HEREBY GIVEN, pursuant to the California Environmental Quality Act (CEQA), that Three Valleys Municipal Water District (TVMWD) plans to improve operational flexibility of the water system and improve the reliability of regional water supplies. The project includes the construction (drilling and equipping) of a groundwater production well. The following hearing has been scheduled for the project:

- TVMWD will consider the Draft Initial Study and Mitigated Negative Declaration (IS/MND), on **Wednesday, November 20, 2019 at 8:00 AM** in the **Three Valleys MWD Administrative Office at 1021 East Miramar Avenue, Claremont.** All interested persons are invited to appear and be heard.

**Project Description**

The proposed project is on TVMWD property located 675 East Miramar Avenue, in the city of Claremont. The main components of the project include construction (drilling and equipping) of a groundwater production well, well casing/louvers, a well enclosure, and water piping. All construction will take place on the property and within the street ROW for construction of the well, well enclosure, and approximately 300 linear feet of water pipe connecting the well to the TVMWD Miramar Plant located at 1021 E. Miramar Avenue in Claremont.

**ENVIRONMENTAL DETERMINATION**

NOTICE IS FURTHER GIVEN that TVMWD has completed an Initial Study of the project in accordance with the State’s guidelines for implementing CEQA. Staff has concluded that there will be no significant negative impact on the environment, and therefore, a Draft Mitigated Negative Declaration has been prepared. The public review period for the Initial Study and Draft Mitigated Negative Declaration (IS/MND) began on September 27, 2019 and concluded on October 28, 2019.

Copies of the IS/MND were available during the public review period on the TVMWD website (www.threevalleys.com), at TVMWD’s office located at 1021 E. Miramar Avenue, Claremont, as well as the Claremont Public Library. TVMWD is open Monday through Thursday 8:00 AM to 5:00 PM.

Failure to file objections to the IS/MND during the public review period or at the public hearing referenced above may constitute a waiver of rights to object to the environmental determination later.

Finally, pursuant to Government Code Section 54954.2(a), any request for disability-related modification or accommodation (including auxiliary aids or services) that is sought to participate in the above-agendized public meeting should be directed to the District’s Executive Assistant at (909) 621-5568 at least 24 hours prior to said meeting.

**Para información en Español, llame (909) 621-5568**

Published: November 8, 2019

\_\_\_\_\_  
/s/ Matthew H. Litchfield  
General Manager / Chief Engineer  
THREE VALLEYS MWD  
Ad#11332463

**San Gabriel Valley Tribune**



## Board of Directors Staff Report

**To:** TVMWD Board of Directors

**From:** Matthew H. Litchfield, General Manager 

**Date:** November 20, 2019

**Subject:** **Adopt Resolution No. 19-11-865 to Approve Initial Study/Mitigated Negative Declaration and CEQA Documentation for the TVMWD Miragrand Groundwater Well, Project No. 58463**

---

<input checked="" type="checkbox"/> <b>For Action</b>	<input type="checkbox"/> <b>Fiscal Impact</b>	<input type="checkbox"/> <b>Funds Budgeted</b>
<input type="checkbox"/> <b>Information Only</b>	<input type="checkbox"/> <b>Cost Estimate</b>	\$

---

### **Staff Recommendation:**

Staff is recommending board adopt Resolution No. 19-11-865 to approve the Initial Study/Mitigated Negative Declaration (IS/MND) and related CEQA documentation for the TVMWD Miragrand Well pending outcome of the Public Hearing.

### **Discussion:**

During the regular Board meeting of November 6, 2019, staff provided an update on the status of TVMWD's planning, preliminary design, and environmental review of the proposed groundwater well on TVMWD property located at the northwest corner of Miramar Avenue and Grand Avenue in the city of Claremont.

In accordance with the California Environmental Quality Act (CEQA) and the Guidelines promulgated thereunder, TVMWD has prepared and circulated a draft Initial Study/Mitigated Negative Declaration (IS-MND) for the proposed project.

TVMWD prepared and published public notifications for this project pursuant to Government Code Section 6061 in newspapers of general circulation: *Inland Valley Daily Bulletin* and *San Gabriel Valley Tribune*. The Notice of Availability and Notice of Intent to Adopt an Initial Study-Mitigated Negative Declaration was published on September 27, 2019 and included information regarding the public comment period that ended on October 28, 2019 and the proposed Public Hearing scheduled during today's Board meeting. A separate Public Hearing notice was also published on November 8, 2019.



To date, TVMWD has received written comments on the IS/MND, during the public review period, that staff believes have been adequately addressed in writing (see attached documents).

Staff recommends Board approval to adopt the IS/MND and related CEQA documentation pending the outcome of the public hearing.

**Strategic Plan Objective:**

- 1.3 – Maintain diverse sources of water supplies and storage, and increase water storage supplies to 10,000 AF
- 2.2 – Utilize 20,000 AF of Miramar treatment plant production to meet annual demands
- 2.3 – Manage water infrastructure and staff operations to minimize costs

**Attachment(s):**

Attachment A – Resolution No. 19-11-865

Attachment B – Initial Study/Mitigated Negative Declaration and CEQA documentation

Attachment C – Notice of Determination (TVMWD Miragrand Well)

**Meeting History:**

November 6, 2019

September 4, 2019

NA/ML

**RESOLUTION NO. 19-11-865**

**A RESOLUTION OF THE BOARD OF DIRECTORS  
OF THE THREE VALLEYS MUNICIPAL WATER DISTRICT  
ADOPTING A MITIGATED NEGATIVE DECLARATION  
FOR THE MIRAGRAND GROUNDWATER PRODUCTION WELL  
PROJECT NO. 58463**

WHEREAS, the Three Valleys Municipal Water District (“District”) is a Municipal Water District located in the County of Los Angeles and organized and operating pursuant to California Water Code Section 71000 et seq.;

WHEREAS, in implementing the statutory functions of a Municipal Water District, the District seeks to improve its service obligations, including the management and storage of local groundwater in the Claremont and Pomona areas of the District;

WHEREAS, in furtherance of said goals, the District has considered the construction and operation of a groundwater production well located at 675 E. Miramar Avenue (i.e. at the parcel on northwest corner of Grand Avenue and Miramar Avenue), in the city of Claremont, as described in the Initial Study attached hereto and incorporated herein (“the Project”);

WHEREAS, the District is subject to the requirements of the California Environmental Quality Act (“CEQA”), Public Resources Code (“PRC”) Section 21000 et seq., and the state Guidelines promulgated thereunder, California Code of Regulations (“CCR”) Section 15000 et seq., which Guidelines have been incorporated into the District’s Local CEQA Guidelines by operation of Resolution No. 07-06-554, since the District qualifies as a “local agency” within the meaning of PRC Section 21062 and CCR Section 15368;

WHEREAS, the Project is a “project” within the purview of CEQA and its Guidelines pursuant to PRC Section 21065 and CCR Section 15378;

WHEREAS, the District is the appropriate “lead agency” under PRC Section 21067 and CCR Section 15367 for making determinations under CEQA and the Guidelines with respect to the potential impact, if any, of the Project on the environment;

WHEREAS, the District caused the preparation of the attached Initial Study for the Project pursuant to CCR Section 15063 which determined that a Mitigated Negative Declaration within the meaning of PRC Sections 21064.5 and 21080(c)(2) and CCR Sections 15369.5 and 15070(b) would adequately address any potential effects of the Project on the environment;

WHEREAS, the District provided public notice and a public review period of not less than thirty (30) days for the Initial Study and the proposed Mitigated Negative Declaration in accordance with CCR Sections 15072 and 15073, and held a public hearing on the proposed Mitigated Negative Declaration on November 20, 2019; and

WHEREAS, the District's Board of Directors has considered the Initial Study, the proposed Mitigated Negative Declaration, all written comments thereto received during the public review process, all written and oral comments thereto received during the public hearing process, and all written and oral responses to said comments.

NOW, THEREFORE, BE IT RESOLVED by the Board of Directors of the Three Valleys Municipal Water District of Los Angeles County that, pursuant to PRC Section 21080(c) and CCR Section 15074(b), on the basis of the whole of the record before the District's Board of Directors (including the Initial Study and any comments received), there is no substantial evidence that the Project will have a significant effect on the environment if the mitigation measures contained in the Mitigated Negative Declaration attached hereto and incorporated herein are incorporated into the Project, and said Mitigated Negative Declaration reflects the District's independent judgment and analysis.

BE IT FURTHER RESOLVED that the District's Board of Directors hereby adopts the attached Mitigated Negative Declaration for the Project and adopts the program for reporting on or monitoring the Project's mitigation measures contained therein as required by CCR Section 15074(d), and hereby approves the Project.

BE IT FURTHER RESOLVED that the District's General Manager is hereby authorized and directed to file with the County Clerk of Los Angeles County a Notice of Determination pursuant to PRC Section 21152(a) and CCR Section 15075 consistent with this Resolution within five working days after the adoption of this Resolution.

BE IT FURTHER RESOLVED that the custodian of the documents or other materials which constitute the record of proceedings upon which the District's decision is based shall be the District's General Manager, and the location of said records shall be the District's headquarters located at 1021 East Miramar Avenue, Claremont, California.

ADOPTED, this 20<sup>th</sup> day of November 2019.

AYES:  
NOES:  
ABSTAIN:  
ABSENT:

---

Bob G. Kuhn, President  
Board of Directors

ATTEST:

---

Brian Bowcock, Secretary  
Board of Directors

SEAL

**Final Initial Study and Mitigated Negative Declaration**  
Three Valleys Municipal Water District  
Proposed Groundwater Production Well and Pipeline  
NWC East Miramar and Grand Avenues  
Claremont, Los Angeles County, California



Prepared for:

**Three Valleys Municipal Water District**  
1207 East Miramar Avenue  
Claremont, California 91711

Prepared by:

**Jericho Systems, INC**  
47 East 1<sup>st</sup> Street  
Redlands, California 92373

November 2019

[This page intentionally left blank]

*Introduction to the Final Initial Study/Mitigated Negative Declaration*

The Three Valleys Municipal Water District (TVMWD), acting as the Lead Agency under the California Environmental Quality Act (CEQA), prepared a Draft Initial Study and Notice of Intent to Adopt a Mitigated Negative Declaration (IS/MND) for the proposed Miragrand Well project. The document was circulated for public review for a period of 30 days between September 27 and October 28, 2019. A total of six comment letters were received during the comment period and have been included in Appendix E along with the Lead Agency's responses to comments.

In addition, during the public review period, TVMWD also conducted Tribal Consultation, as required under Assembly Bill 52 (AB 52), with the Gabrieleño Band of Mission Indians–Kizh Nation. Consultation resulted in revisions to the discussion of Tribal Cultural Resources in the Initial Study and amendments to the mitigation measures identified in the Draft Initial Study and Draft Mitigation Monitoring and Reporting Program (MMRP). Amended text is included in the Final Initial Study in Section 3.5, *Cultural Resources*, and Section 3.18, *Tribal Cultural Resources*. The amended text, including revised mitigation measures were found to be consistent with the intent of the Draft Initial Study text regarding Tribal Cultural Resources and does not represent significant new information or new mitigation measures that would require recirculation of the Draft IS/MND (CEQA Guidelines Section 15073.5(c)). New text is double underlined and deleted text is ~~stricken through~~. In addition, in response to a comment from the City of Claremont, TVMWD will replace the proposed curb and gutter system with a rock swale system to match the existing local drainage system. Therefore, Figure 6, *Conceptual Site Plan*, has been updated.

Prior to approving the project, the Three Valleys Municipal Water District Board (Board) must consider the MND together with any comments received during the public review period. The Board may adopt the proposed MND only if it finds on the basis of the whole record before it (including the Initial Study, any comments received, any revisions to the project description, or refinement of mitigation measures), that there is no substantial evidence that the project will have a significant effect on the environment and that the MND reflects the lead agency's independent judgment and analysis.

TVMWD prepared this Final IS/MND in accordance with the California Environmental Quality Act (CEQA; California Public Resources Code Section 21000, *et seq.*) and the "Guidelines for the Implementation of the California Environmental Quality Act" (California Code of Regulations, Title 14, Section 15000, *et seq.*, State *CEQA Guidelines*).

[This page intentionally left blank]

## Table of Contents

1	PROJECT INFORMATION.....	1
2	INTRODUCTION TO THE INITIAL STUDY.....	3
2.1	Project Purpose and Overview.....	3
2.2	Project Location and Description of Surrounding Area.....	4
	Project Location.....	4
	Description of Surrounding Area.....	5
2.3	Project Description.....	5
	Project Site.....	6
	Connection to Grand Avenue Pipeline.....	7
	Well Maintenance Space Requirements.....	7
	Well Drilling Process.....	7
	Conceptual Construction Site Layout.....	8
	Construction Schedule.....	8
	Construction Traffic Control.....	9
	Construction Assumptions.....	9
	Operational Considerations.....	11
3.	Environmental Evaluation.....	31
3.01	Environmental Factors Potentially Affected.....	31
3.02	Determination (To be completed by the Lead Agency).....	31
3.03	Evaluating Environmental Impacts.....	32
3.1	Aesthetics:.....	34
	Discussion.....	34
	Mitigation Measures.....	36
	Impact Conclusions.....	36
3.2	Agriculture and Forestry Resources:.....	36
	Discussion.....	37
	Mitigation Measures.....	38
	Impact Conclusions.....	38
3.3	Air Quality:.....	38
	Air Quality Standards and Attainment.....	39
	Air Quality Management.....	42
	Air Emission Thresholds.....	42



	Construction Emissions.....	44
	Operational Emissions .....	44
	Mitigation Measures .....	47
	Impact Conclusions.....	48
3.4	Biological Resources: .....	48
	Discussion .....	49
	Mitigation Measures .....	50
	Impact Conclusions.....	51
3.5	Cultural Resources:.....	51
	Discussion .....	51
	Prehistoric Context.....	51
	Ethnohistoric Context .....	52
	Historic Context.....	53
	Cultural Resources Assessment .....	54
	Mitigation Measures .....	58
	Impact Conclusions.....	60
3.6	Energy:.....	61
	Discussion .....	61
	Building Energy Efficiency Standards.....	62
	Senate Bill 350 .....	62
	Senate Bill 100.....	62
	Project Construction.....	63
	Mitigation Measures .....	64
	Impact Conclusions.....	64
3.7	Geology/Soils/Paleontological Resources: .....	64
	Discussion .....	65
	Mitigation Measures .....	69
	Impact Conclusions.....	69
3.8	Greenhouse Gas Emissions:.....	69
	Discussion .....	69
	Significance Thresholds for GHG.....	71
	Mitigation Measures .....	75
	Impact Conclusions.....	75
3.9	Hazards and Hazardous Materials:.....	75
	Mitigation Measures .....	78

	Impact Conclusions.....	78
3.10	Hydrology and Water Quality:.....	79
	Construction Impacts .....	80
	Operational Impacts .....	81
	Mitigation Measures .....	84
	Impact Conclusion .....	84
3.11	Land Use and Planning: .....	84
	Discussion .....	84
	SCAG Regional Transportation Plan/Sustainable Communities Strategies .....	85
	Mitigation Measures .....	87
	Impact Conclusions.....	87
3.12	Mineral Resources: .....	87
	Discussion .....	87
	Mitigation Measures .....	88
	Impact Conclusions.....	88
3.13	Noise: .....	88
	Discussion.....	89
	Regulatory Setting.....	92
	Vibration Descriptors.....	103
	Vibration Perception .....	103
	Vibration Propagation.....	103
	Regulatory Setting.....	104
	Construction Vibration.....	104
	Mitigation Measures .....	105
	Impact Conclusions.....	105
3.14	Population and Housing:.....	106
	Discussion .....	106
	Mitigation Measures .....	106
	Impact Conclusions.....	106
3.14	Public Services:.....	107
	Discussion .....	107
	Mitigation Measures .....	109
	Impact Conclusions.....	109
3.16	Recreation: .....	109
	Discussion .....	109

---

	Mitigation Measures .....	110
	Impact Conclusions.....	110
3.17	Transportation:.....	110
	Discussion .....	110
	Mitigation Measures .....	112
	Impact Conclusions.....	112
3.18	Tribal Cultural Resources:.....	112
	Discussion .....	113
	Mitigation Measures .....	117
	Impact Conclusions.....	119
3.19	Utilities and Service Systems:.....	119
	Discussion .....	120
	Mitigation Measures .....	121
	Impact Conclusions.....	121
3.20	Wildfire:.....	122
	Discussion .....	122
	Mitigation Measures .....	123
	Impact Conclusions.....	124
3.21	Mandatory Findings of Significance:.....	124
	Discussion .....	124
	Biological Resources.....	125
	Cultural Resources/Tribal Cultural Resources.....	125
4	REFERENCES.....	127
5	MITIGATION MONITORING AND REPORTING PROGRAM .....	129

## LIST OF TABLES

Table 1	Land Use Designation and Current Land Use.....	5
Table 2A	State and Federal Ambient Air Quality Standards .....	40
Table 2B	South Coast Air Basin Attainment Status.....	41
Table 3	Localized Significance Thresholds (Pounds per Day).....	44
Table 4	Constuction Emissions - Well & Pump (Pounds per Day).....	45
Table 5	Constuction Emissions - Pipeline (Pounds per Day).....	45
Table 6	Operational Emissions (Pounds per Day) .....	46
Table 7	GHG Construction Emissions – Well and Pump Station (MT Per Year).....	72
Table 8	GHG Construction Emissions – Pipeline (MT Per Year).....	72
Table 9	Greenhouse Gas Operational Emissions (MT Per Year).....	73
Table 10	Project Consistency with SCAG's RTP/SCS.....	84
Table 11	Typical A-Weighted Noise Levels.....	89
Table 12	Land Use Compatibility Guidelines .....	94
Table 13	Long Term Noise Measurement Data .....	97
Table 14	C/T Equipment Noise Emissions and Acoustical Usage Factor Database .....	98
Table 15	Construction Noise Levels (dBA, Leq(h) .....	100
Table 16	Estimated Peak Hour Project Trips .....	111

## LIST OF FIGURES

Figure 1	Regional Location.....	13
Figure 2	Local Vicinity.....	15
Figure 3	conceptual Site Plan .....	17
Figure 4	Preliminary Drilling Location.....	19
Figure 5	Preliminary Site Layout for Construction.....	21
Figure 6	Conceptual Site Plan - Post Well Equipping.....	23
Figure 7	Discharge Location .....	25
Figure 8	Proposed Connection to Grand Avenue Pipeline.....	27
Figure 9	Well Enclosure Building .....	29

## APPENDICES

- A Air Quality/Greenhouse Gas Data Sheets
- B Cultural Resources Report
- C Noise Report
- D Traffic Memo
- E Comments on Draft Initial Study and Responses

**ACRONYMS**

<b>Acronym</b>	<b>Definition</b>
μPa	micro Pascal
AB	Assembly Bill
af	acre feet
afy	acre feet per year
AIA	Airport Influence Area
ALUCP	Airport Land Use Compatibility Plan
AQMP	Air Quality Management Plan
bgs	below ground surface
BMP	best management practices
CAAQS	California Ambient Air Quality Standards
CalEEMod	California Emissions Estimator Model
CARB	California Air Resources Board
CCR	California Code of Regulations
CCML	Cement mortar-lined and coated steel
CDFM	cumulative departure from mean
CEC	California Energy Commission
CEQA	California Environmental Quality Act
CESA	California Endangered Species Act
cfs	cubic feet per second
CH <sub>4</sub>	methane
CNEL	Community Noise Exposure Level
CO	Carbon monoxide
CO <sub>2</sub>	Carbon dioxide
CO <sub>2e</sub>	Carbon dioxide equivalent
COPCs	constituents of potential concern
Cr-6	Chromium-6
DDW	California Department of Drinking Water
DIP	Ductile iron pipe
DNL	Day/Night Level
DTSC	California Department of Toxic Substances Control
DWR	California Department of Water Resources
EIA	US Energy Information Administration
EPA	US Environmental Protection Agency
ESA	Federal Endangered Species Act
ft-bgs	feet below ground surface
ft-msl	feet above mean sea level
FHWA	Federal Highway Administration
FMMP	Farmland Mapping and Monitoring Program
FTA	Federal Transit Administration

<b>Acronym</b>	<b>Definition</b>
GHG	greenhouse gasses
gpm	gallons per minute
GWH	Gigawatt hours
GWP	Global Warming Potential
HFC	hydrofluorocarbons
IPCC	International Panel on Climate Change
kWh	Kilowatt hour
LST	localized significance thresholds
MG	million gallons
mgd	million gallons per day
MS4	Municipal Separate Storm Sewer System
MT	Metric tons
MWD	Metropolitan Water District of Southern California
NAAQS	National Ambient Air Quality Standards
NHPA	National Historic Preservation Act
N/m <sup>2</sup>	micro-Newton per square meter
NO <sub>2</sub>	Nitrogen Dioxide
NO <sub>x</sub>	Nitrous Oxides
NPDES	National Pollutant Discharge Elimination System
NRHP	National Register of Historic Places
NTU	Nephelometric turbidity units
O <sub>3</sub>	ozone
Pb	lead
PCE	perchloroethylene
PDR	Preliminary Design Report
PFC	perflouorocarbons
PM	Particulate matter 10 microns or 2.5 microns
ppb	parts per billion
PPV	Peak particle velocity
R2	Residential, 0.1 to 2.0 dwelling units per acre
ROG	Reactive organic gasses
RR	Residential 1 dwelling unit per acre
RMS	Root mean square
SB	Senate bill
SCAB	South Coast Air Basin
SCAG	Southern California Association of Governments
SCAQMD	South Coast Air Quality Management District
SCE	Southern California Edison
SERP	State Environmental Review Process
SGMA	Sustainable Groundwater Management Act
SF <sub>6</sub>	Sulfur hexafluoride

<b>Acronym</b>	<b>Definition</b>
SO <sub>2</sub>	Sulfur dioxide
SRA	Source receptor area
SWPPP	Stormwater Pollution Prevention Plan
SWRCB	State Water Resources Control Board
TCE	trichloroethylene
TCP	Traffic control plan
TCR	Tribal Cultural Resources
TDS	Total Dissolved Solids
TS	Temporary Surplus
TVMWD	Three Valleys Municipal Water District
UCHB	Upper Claremont Heights Basin
USEPA	US Environmental Protection Agency
VdB	Vibration level
VMT	Vehicle miles traveled
WTP	water treatment plant

## 1 PROJECT INFORMATION

1. *Project Title:* Miragrand Groundwater Production Well Project
2. *Lead Agency Name and Address:* Three Valleys Municipal Water District  
1021 E. Miramar Avenue  
Claremont, California 91711
3. *Contact Person and Phone Number:* Ray Evangelista, Project Manager  
(909) 621-5568
4. *Project Location:* 675 E. Miramar Avenue  
Northwest corner of Miramar Avenue and Grand Avenue  
Assessor's Parcel Number 8671-009-019  
Lat/Long 35° 07' 45" N/117° 42' 11" W  
Section 34, T1N, R8W, Mt Baldy 7.5" quadrangle
5. *General Plan:* Residential 2 (R2) 0.1 to 2.0 dwelling units/acre
6. *Zoning:* RR 35,000 – Residential, 1 gross acre/dwelling unit

### 7. *Lead Agency Discretionary Actions:*

Approval of the following:

- Site Plan
- Mitigated Negative Declaration

### 8. *Other agencies whose approval is required (e.g., permits, financing approval, or participation agreement.):*

City of Claremont

- Encroachment Permit for development of the pipeline within public right-of-way
- Review and approval of an Erosion Control Plan and a Construction Traffic Control Plan

County of Los Angeles Department of Public Health, Drinking Water Division

- Well permit

State Department of Water Resources

- Well designation number upon completion of well construction and submittal of a Well Completion Report



State Water Resources Control Board

- Statewide De minimus Permit under the State's General Construction Permit (NPDES)

## 2 INTRODUCTION TO THE INITIAL STUDY

This Initial Study is an informational document intended to inform the lead agency, other responsible or interested agencies, and the public of potential environmental effects of the proposed project. The environmental review process has been established to enable public agencies to evaluate potential environmental consequences and to examine and implement methods of eliminating or reducing any potential significant adverse impacts.

### 2.1 Project Purpose and Overview

Three Valleys Municipal Water District (TVMWD) is a wholesale water purveyor that was established in 1950 as the Pomona Valley Municipal Water District. TVMWD adopted its current name in 1981 to better reflect its service areas in the Pomona, Walnut and San Gabriel valleys. Its service area covers 133 square miles and includes the cities of Glendora, San Dimas, Claremont, Covina, La Verne, Pomona, Walnut, Rowland Heights, and Diamond Bar. TVMWD has a 13-member agency including Boy Scouts of America, Cal Poly Pomona University, Covina Irrigation Company, Golden State Water Company, Mt. San Antonio College, Rowland Water District, Suburban Water Systems, Valencia Heights Water Company, Walnut Valley Water District, the cities of Covina, Glendora, La Verne and Pomona.

TVMWD is a member agency of the Metropolitan Water District (MWD) of Southern California. This relationship allows TVMWD to supply potable water from MWD's Weymouth Water Treatment Plant, located in the City of La Verne. In addition, TVMWD provides potable water from its Miramar Water Treatment Plant (Miramar Plant) which was constructed in 1987. The Miramar Plant, located in the City of Claremont northeast of the project site, has a capacity of 25 million gallons per day (mgd). Two existing groundwater production wells (Wells No. 1 and 2) are located at the Miramar Plant site. A third groundwater production well located off Grand Avenue (Grand Avenue Well) was recently constructed and is scheduled for equipping in the next year. All three wells, plus the proposed Miragrand well will supply groundwater to the Miramar Plant. Figure 1, *Regional Location*, shows the project site within the larger region. Figure 2, *Project Vicinity*, shows the project site within the existing residential neighborhood. Figure 3, *Project Site Photos*, shows the project site and surrounding land uses.

The overall goal of TVMWD's Miragrand well is to increase groundwater extraction capability within the Six Basins, an adjudicated groundwater basin since 1999, utilizing both its production rights and storage/recovery account. Six Basins is composed of six sub-basins adjacent to the foothills of the San Gabriel Mountains in the eastern Los Angeles County and western San Bernardino County that underlay the cities of Pomona, La Verne, Claremont and Upland, and the unincorporated community of San Antonio Heights adjacent to the City of Upland. The six sub-basins are the Pomona Basin, Live Oak Basin, Upper Claremont Basin, Lower Claremont Basin, and Canyon Basin, which are all naturally separated by geologic features. TVMWD's proposes to construct the Miragrand Well for the following reasons:

- Enhance production capabilities and finished water quality to enhance and improve Miramar Plant's treated drinking water supply,
- Provide regional benefit to TVMWD's member agencies by strengthening local supply reliability and adding redundancy to TVMWD's existing groundwater production system; and
- Provide value to Six Basins with the ability to control the potential rising groundwater through extraction.

JIG Consultants prepared a Preliminary Design Report (PDR) (August 2019), to outline the basic design concepts for construction of the proposed well site. The PDR includes the following information to assist TVMWD in its decision-making process regarding the Miragrand well, and was used in the preparation of this Initial Study:

1. Prepare plans including:
  - a. A site plan showing the proposed well location with respect to critical area features. (see Figure 4, *Preliminary Drilling Location*)
  - b. A detailed site map for well drilling and construction. (see Figure 5, *Preliminary Site Layout for Construction*)
  - c. A conceptual site plan of well equipping including building enclosure, perimeter fencing, asphalt pavement and other above ground improvements. (See Figure 6, *Conceptual Site Plan -Post Well Equipping*)
  - d. A conceptual layout for discharge pipe connection to Grand Avenue Pipeline. (see Figure 7, *Discharge Location*)
2. Establish hydrogeological conditions for drilling and well design (e.g. expected subsurface sediments, depth to groundwater, aquifer properties, groundwater quality, proximity to surface water sources, and location relative to existing area wells).
3. Develop preliminary well design diagram and description showing the well depth, casing diameter, casing materials, perforation interval and ancillary piping (i.e. gravel feed tube, sounding tubes, etc.).
4. Perform preliminary calculations for sizing of well pump and motor.

## 2.2 Project Location and Description of Surrounding Area

### Project Location

Figure 1 shows the location of the proposed well site within the larger southern California region. TVMWD's Miramar Plant and groundwater production wells are located in the Upper Claremont groundwater basin, one of six basins within the Six Basins that underlie the region. The basins are delineated by underground faults and related barriers.

### Description of Surrounding Area

Figure 2 shows the project site and surrounding area. The project site is located in a single-family residential neighborhood at the northwest corner of Miramar Avenue and Grand Avenue.

Currently TVMWD is using the vacant site for construction staging (equipment parking and material stockpiling) for the Grand Avenue well located approximately ½ mile south of the project site. Figure 3 also shows the locations where photographs of the project site and vicinity were taken. Table 1, *Land Use Designations and Current Land Uses*, lists the land use designations for the project site and immediate vicinity.

**Table 1 Land Use Designation and Current Land Uses**

Direction	Land Use	Land Use and Zoning Designations
Project Site	Undeveloped Site	GP Residential 2 - 0.1 to 2 du/ac Z Rural Residential (RR) 35,000 1 du/ac
North	SFR	GP Residential 2 - 0.1 to 2 du/ac Z Rural Residential (RR) 35,000 1 du/ac
East	SFR	GP Residential 2 - 0.1 to 2 du/ac Z Rural Residential (RR) 35,000 1 du/ac
South	SFR	GP Residential 6 - 2.1 to 6 du/ac Z Residential (R) 13,000 sf min lot size
West	SFR	GP Residential 2 - 0.1 to 2 du/ac Z Rural Residential (RR) 35,000 1 du/ac

Source: Site Visit, July 24, 2019; City of Claremont General Plan Land Use, Character, Preservation Element and Land Use Map, Zoning Code Chapter 16.007 Rural Residential District and Chapter 16.001 Residential District; and Zoning Map.

Notes:

1. SFR = Single Family Residential; GP = General Plan, Z = Zoning District, RR = Rural Residential; RS = Residential.

### 2.3 Project Description

TVMWD is proposing the development of a new well to supplement the existing groundwater production wells currently in operation to provide high-quality treated drinking water to its member agencies. Figure 6 shows that the southerly portion of the project site, approximately 10,000 square feet of the approximately one-acre site will be developed with the well and related infrastructure. The remaining approximately ¾ acre will be maintained with landscaping and hard groundcover. This may consist of gravel, mulch or other cover to reduce the prevalence of weeds and control dust from the undeveloped portion of the site. The entire one-acre site will be enclosed with a perimeter wall/fence.

Once completed, approximately 700 to 800 acre-feet per year (AFY) of untreated groundwater would be pumped from this production well and conveyed through a new

approximately 150 linear foot 8-inch ductile iron pipe (DIP) to interconnect with the existing water line on Grand Avenue as it intersects with Miramar Avenue. Ultimately, this water will be conveyed to TVMWD's Miramar Plant (1021 E. Miramar Avenue) where it will be treated and made available to its member agencies. The proposed alignment is shown in Figure 8, *Conceptual Connection to Grand Avenue Pipeline*.

The Miragrand well project will be developed with the following elements:

### Project Site

- The groundwater well and pipeline will be developed underground at the project site.
- Aboveground pumps and related equipment will be housed within a small concrete masonry unit block building that will provide security and sound attenuation. (see Figure 9, *Well Enclosure Building*. The building will contain an interior wall which divides the well room and the electrical room. For additional sound attenuation, the interior of the well room will be lined with acoustical wall panels.
- The project includes a concrete masonry wall along the north and west sides of the well site and a three-foot high block or brick wall along the east and south sides of the well site, topped with a three-foot wrought iron fence.
- The remaining well site area will be improved with a formal surface such as asphalt concrete pavement. The pavement will allow access around the building enclosure and the electrical transformer. The finished grade of the pavement will be sloped for positive drainage into a new catch basin.
- Handling of water produced during well drilling construction (i.e. during well development and pump testing) activities - Water will be directed (piped) to two or three 20,000 gallon Baker tanks to allow sediment to settle and reduce water turbidity below 100 nephelometric turbidity units (NTU) before allowing water to recharge onsite in an "earthen basin" and/or directing water towards an existing catch basin on Grand Avenue. If directed towards existing catch basin, TVMWD will convey the water into the Baker tanks and then into the newly constructed 8-inch discharge pipeline and fire hydrant. TVMWD will comply with requirements of its existing National Pollution Discharge Elimination System (NPDES) Discharge permit.
- Handling of the start-up water after completion of well construction (i.e. after drilling and well equipping construction) - TVMWD anticipates all or most of the water will be recharged onsite by directing it into an "earthen basin" to percolate back into the groundwater basin. A portion of the water may be directed towards the existing catch basin on Grand Avenue, via the discharge pipeline, after confirming that turbidity of the water is less than 100 NTU. TVMWD will comply with requirements of its existing NPDES Discharge permit.
- A sliding gate for access only by authorized personnel will be constructed along the southwest side of the fence on Miramar Avenue.
- The project includes development of sidewalks along the property line on Miramar and Grand Avenues.

- Landscaping is included between the sidewalks and brick wall along Miramar and Grand Avenues.

### Connection to Grand Avenue Pipeline

- The Miragrand well will be connected by an 8-inch pipeline across the site and down Grand Avenue to the 12-inch pipeline in the intersection of Miramar Avenue and Grand Avenue. The stub-out for this connection was strategically located outside of the pavement to reduce disturbance to Miramar Avenue when the proposed Miragrand Well discharge pipeline is in construction. Figure 8 shows the general alignment of the pipe from the well building enclosure to the subject stub-out. The new water line will be constructed in an open trench and as it exits the project site, the trench will cross the Grand Avenue roadway, and will connect to the existing 12-inch waterline in Grand Avenue.

### Well Maintenance Space Requirements

For future maintenance of the well pump, the site will require laydown space near the building enclosure, preferably adjacent to the 48-inch square hatch. The laydown space is required for a crane to remove the pump columns and line shafts, and to place and store the 10-foot segments near the building. Figure 6 is a conceptual site plan showing the various site improvements associated with the proposed Miragrand well including the “laydown area” near the building.

### Well Drilling Process

Figure 4 shows where the well will be developed; and the staging area, the location of the drill rig, mud tank and settling tanks. At the end of the drilling process, the drill rig and tanks will be removed from the site.

The well will be drilled using the fluid reverse circulation rotary drilling method that utilizes water or an approved drilling fluid as the circulating medium. The well will be drilled in two passes; the first pass (pilot borehole) will be drilled to a depth of 900 feet using a 17 1/2 - inch diameter rotary drilling bit. Data will be collected during and after drilling of the pilot borehole as a basis for the final well design. Once data collection in the pilot borehole is completed, it will be enlarged (second pass) to its final diameter of 28-inches from 100 feet to 130 feet below ground surface (bgs) and 26-inches from 130 feet to 920 feet bgs.

Equipment to be used in the drilling process would consist of a drilling rig, pipe truck, driller’s trailer (doghouse), and settling tanks for the discharge water. A minimum of two 20,000-gallon discharge water settling tanks would be used for clarification of water prior to discharge; and would be removed upon completion of construction. Although settling times will vary depending on the nature of suspended particles in the discharge water (e.g. fine-grained sand and silt require more time to settle), previous drilling projects in the area have shown that two tanks are adequate to clarify water such that the suspended sediment in the discharge meets regulatory criteria (in this case, 100 NTU total suspended solids).

However, to ensure adequate storage, TVMWD may use a third Baker tank on-site. The NTU measurement is based on the cloudiness of the water and is one of the tests used to evaluate water quality. If the drilling process requires the use of an approved drilling fluid as the circulation medium, liquid (water or drilling fluid) generated from well development and pumping tests may require that the water be hauled off site to an approved disposal site. Otherwise, as shown in Figure 7, a temporary pipeline between the well site to a point near the southeast corner of Miramar and Grand Avenues could be constructed (trenching through the intersection), to send the water down to the existing catch basin on Grand Avenue. Sediment that settles to the bottom of the settling tanks may be removed and transferred to a third party or used on that portion of the project site (northerly  $\frac{3}{4}$ ) that will be improved with landscape/hardscape.

### Conceptual Construction Site Layout

During the well drilling process, the area will be fenced temporarily with chain link fencing. In addition, to attenuate noise associated with the drilling process, temporary noise attenuation panels up to 24 feet in height will be placed between the well site and adjacent residences. Other techniques include adherence to the City of Claremont's Noise Ordinance requirements that limit hours of construction to between 7:00 am and 6:00 pm; Monday through Saturday. In addition, as described previously, water used in the drilling process will be contained in a minimum of two 20,000 gallon settling tanks.

### Construction Schedule

Approval of the well project is anticipated to occur by the end of 2019. Between approval of the project and construction, TVMWD staff and consultants will be completing design and construction drawings for submittal to permitting agencies (e.g. State Department of Water Resources). Therefore, a conservative estimate for the start of well development (Phase 1) construction is December 2021 with completion in February 2022. Well construction will typically consist of the following elements:

- Borehole Drilling –10 to 14 days; 24/7 operation
- Zone Testing –5 to 6 days; daytime operation
- Well Construction(casing/screen)–3 to 5 days; 24/7 operation
- Trenching for the temporary storm drain - 5 to 7 days operation, or on-site earthen catch basin
- Initial Development –5 to 7 days; 24/7 operation
- Test Pump Installation –2 days; daytime operation
- Pumping Development –5 to 10 days; daytime operation
- Pumping Tests –3 to 4 days; 24/7 operation

Site development including the pipeline installation and connection will be completed in Phase 2 which is tentatively scheduled to occur between November 2021 and March 2022. In addition to well construction, as shown in Figure 6, the project includes the construction

of a block wall along the north and west sides of the well site, a combination brick or block wall with wrought iron fencing along the east (Grand Avenue) and south (Miramar Avenue) sides of the site, sidewalks, landscaping, and a sliding access gate on Miramar Avenue.

### Construction Traffic Control

The construction contractor will be responsible for development of a traffic control plan (TCP) in order to minimize impacts on residents leaving and returning to the neighborhood during construction. The TCP will include consideration of vehicles, bicycles and pedestrians that may need access through the construction zone along Miramar Avenue in the vicinity of the project site.

### Construction Assumptions

Construction activities for the proposed well and pipeline will follow the same general requirements as follows:

#### *Development of the New Well*

- All construction activities will occur between the hours of 7 am and 6 pm Monday through Saturday (no Sunday or holiday hours).
- Not all construction equipment will be operating at the same time or for the length of the workday.
- Construction of a new well would involve drilling, installing well casing and pump shaft, pump motor housing and piping to connect the well to a conveyance system.
- Depth of the new well is estimated to be approximately 900 feet bgs. Use average depth of 800 feet.
- Construction equipment for well sites would be limited to small to medium sized trucks, drilling rig, welder, and electrical tools.
- Development of a new well will require the delivery and set up of the drilling rig. Round trip at 45 mph
- The drilling and development of the well will take approximately 45 calendar days, of which 15 to 20 days would include 24-hour drill activity.
- Delivery of the well casings, pumps, motors, etc. for each well is forecast to result in about 60 miles being traveled by trucks averaging about 45 mph.
- Calculations assume up to 6 workers will each commute 40 miles round-trip to the work site.
- Typically, well drilling requires only minimal earth movement and/or grading.
- The well casings are expected to be welded.
- Well development and installation will require six weeks of a diesel generator.
- The area of disturbance of the site is anticipated to be ½ acre or less.
- No maintenance of construction equipment is anticipated to be done on site.
- Drilling process water or first flush water – TVMWD is considering two options (1) and on site earthen catch basin that would receive water from the Baker tanks at



controlled intervals; or (2) release into the existing catch basin on Grand Avenue, via the discharge pipeline, after confirming the turbidity is less than 100 nephelometric turbidity units (NTU).

### *New Conveyance Pipeline*

- For the purposes of this evaluation, the assumption is made the new pipe would have a diameter of 8 inches.
- Pipeline construction would involve trenching to a depth of 5 feet with a typical trench of 3 feet wide, with an additional 3 feet along the trench for a stockpile area. The pipeline construction would occur within the intersection of Grand Avenue and Miramar because the new well will be connected via a short (approximately 150 feet) pipeline to connect to the existing pipeline in Grand Avenue. Trenching would include the removal and hauling away of asphalt (may use a concrete saw to score the trench lines), excavating and stockpiling soil adjacent to the trench, use of a water truck to control dust during construction, placement of the pipe, backfilling, and resurfacing the street with new asphalt.
- Staging of equipment is assumed to occur on the well site, so no daily arrival/departure of equipment is assumed.
- Construction workers would commute to the site with an average one-way commute of 20 miles.
- Because a pipeline project is linear, it is assumed that trenching may occur simultaneously with backfilling once new pipe is in place. Therefore, more than one piece of some equipment such as the backhoe and dump truck may be necessary.
- The average disturbance of the site on a daily basis is assumed to be less than 1 acre.
- The number of construction workers is assumed to be 10, including equipment operators and laborers.
- No maintenance of construction equipment is anticipated to be done on site.

### *Site Development*

- Asphalt paving of the approximately 10,000 square foot well site.
- Development of the perimeter block wall (north and west) and a combination block wall/wrought iron fence, perimeter landscaping, and sidewalks along the site frontage along Miramar Avenue and Grand Avenue the length of the property (app. one-acre site). The wall along Miramar Avenue includes a sliding fence for access.
- Remaining site area not developed for the well will be improved with landscape/hardscape material.
- Buildout of the well site including installation of the pump, electrical supply, monitoring equipment and the building enclosing all of the components associated with the well.
- Typical construction equipment that may be used during construction phases include the following:

Equipment	Number of Pieces	Hours of Operation per Day
Backhoe/Excavator	1	6
Crane	1	6
Pavement cutter	1	6
Grinder	1	6
Delivery trucks <sup>1</sup>	2	6
Dump truck	1	
Water truck	1	4
Paving machine	1	6
Roller/vibrator	1	6
Total	10	--

## Notes:

1. Delivery drivers are not counted in the number of construction workers as it is assumed that they are employed by the supplier and not the contractor.

### Operational Considerations

The well pump and related pump motor, pipes, valves and metering equipment will be housed in a small freestanding building. In addition to these, the building will house a separate electrical room. The building will be built with concrete masonry unit (CMU) – concrete blocks with a roof of composite material. For additional sound attenuation, the interior of the well room will be lined with acoustical wall panels.

The area of the site not developed as part of the well facility will be maintained as a landscaped area behind the perimeter wall/fence.

[This page intentionally left blank]

**Legend**

★ Site Vicinity

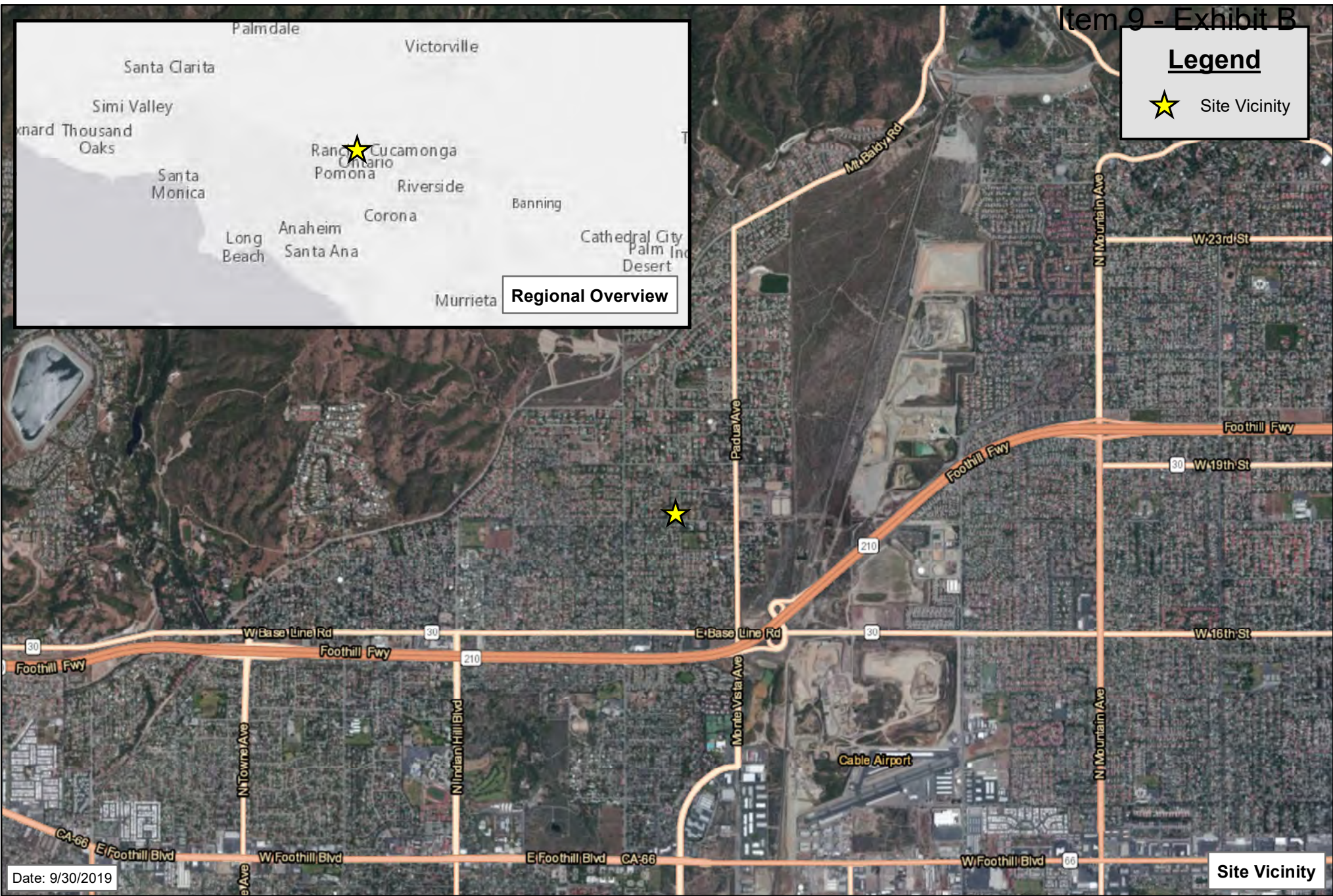

Date: 9/30/2019

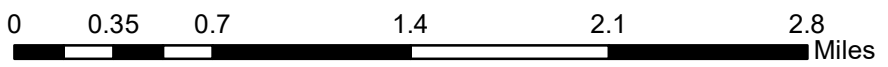

Service Layer Credits: Esri, HERE, Garmin, (c) OpenStreetMap contributors  
 Esri, HERE, Garmin, (c) OpenStreetMap contributors, and the GIS user community  
 Source: Esri, DigitalGlobe, GeoEye, Earthstar Geographics, CNES/Airbus DS, USDA,



**Figure 1 - Regional Overview  
Site Vicinity**

Well 4  
Miragrand Site  
TVMWD

[This page intentionally left blank]

# Legend



Miragrand Well Site



Noise Monitoring Location

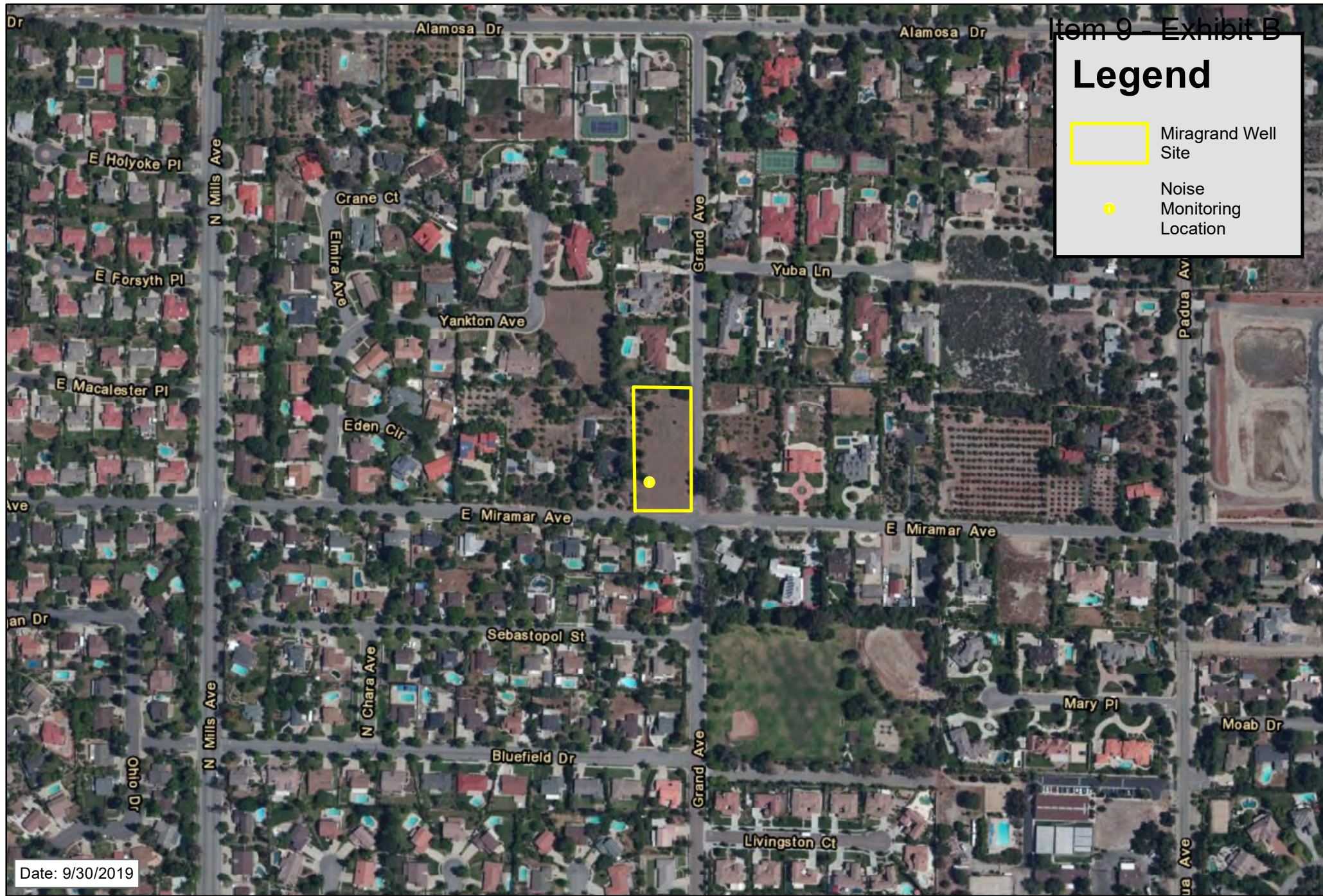

Date: 9/30/2019

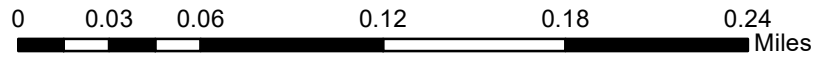

Imagery Date: 9/26/2018

Service Layer Credits: Esri, HERE, Garmin, (c) OpenStreetMap contributors  
Source: Esri, DigitalGlobe, GeoEye, Earthstar Geographics, CNES/Airbus DS, USDA, USGS,



1 inch = 333 feet

## Figure 2 Site Location

Miragrand Well Site  
TVMWD

[This page intentionally left blank]

# Legend

 Well 4 Site Boundary



0 0.015 0.03 0.06 0.09 0.12 Miles

Imagery Date: 9/26/2018

Service Layer Credits: Esri, HERE, Garmin, (c) OpenStreetMap contributors  
Source: Esri, DigitalGlobe, GeoEye, Earthstar Geographics, CNES/Airbus DS, USDA, USGS,



1 inch = 167 feet

### Figure 3 Site Location

Well 4  
Miragrand Site  
TVMWD



[This page intentionally left blank]



**LEGEND:**

- = PROPOSED WELL
- = EXISTING SEWER MANHOLE
- = EXISTING FIRE HYDRANT
- = EXISTING CATCH BASIN
- = PARCEL BOUNDARY
- = 50' RADIUS BARRIER FROM NEAREST MANHOLE
- = RIGHT-OF-WAY
- = STREET CENTERLINE

Source: JIG Figure 6



Not to scale

Figure 4  
Preliminary Drilling Locations

Miragrand Well Site  
TVMWD

[This page intentionally left blank]

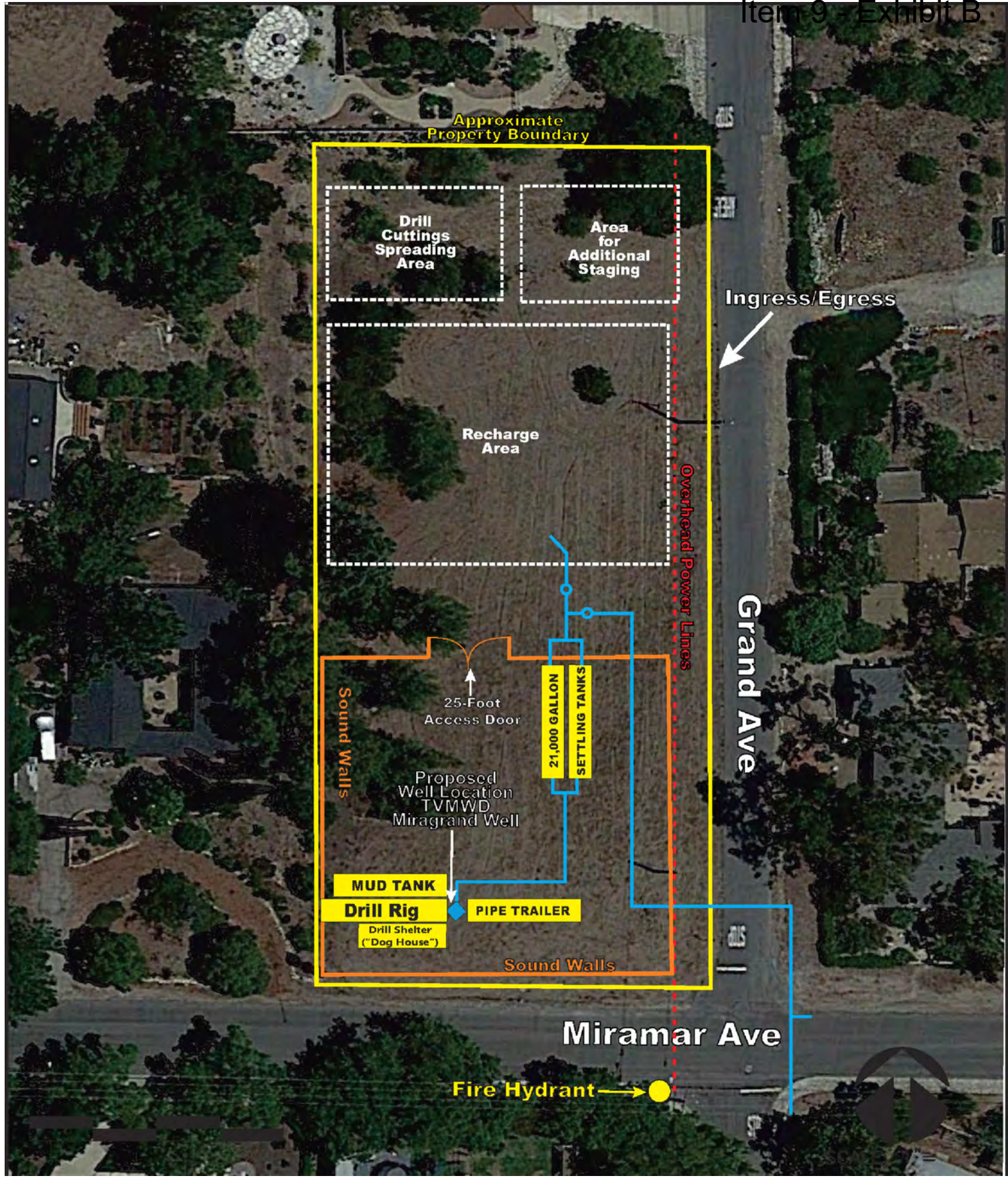

Source: JIG Figure 4



Not to scale

Figure 5  
Preliminary Construction Site Layout

Miragrاند Well Site  
TVMWD

[This page intentionally left blank]

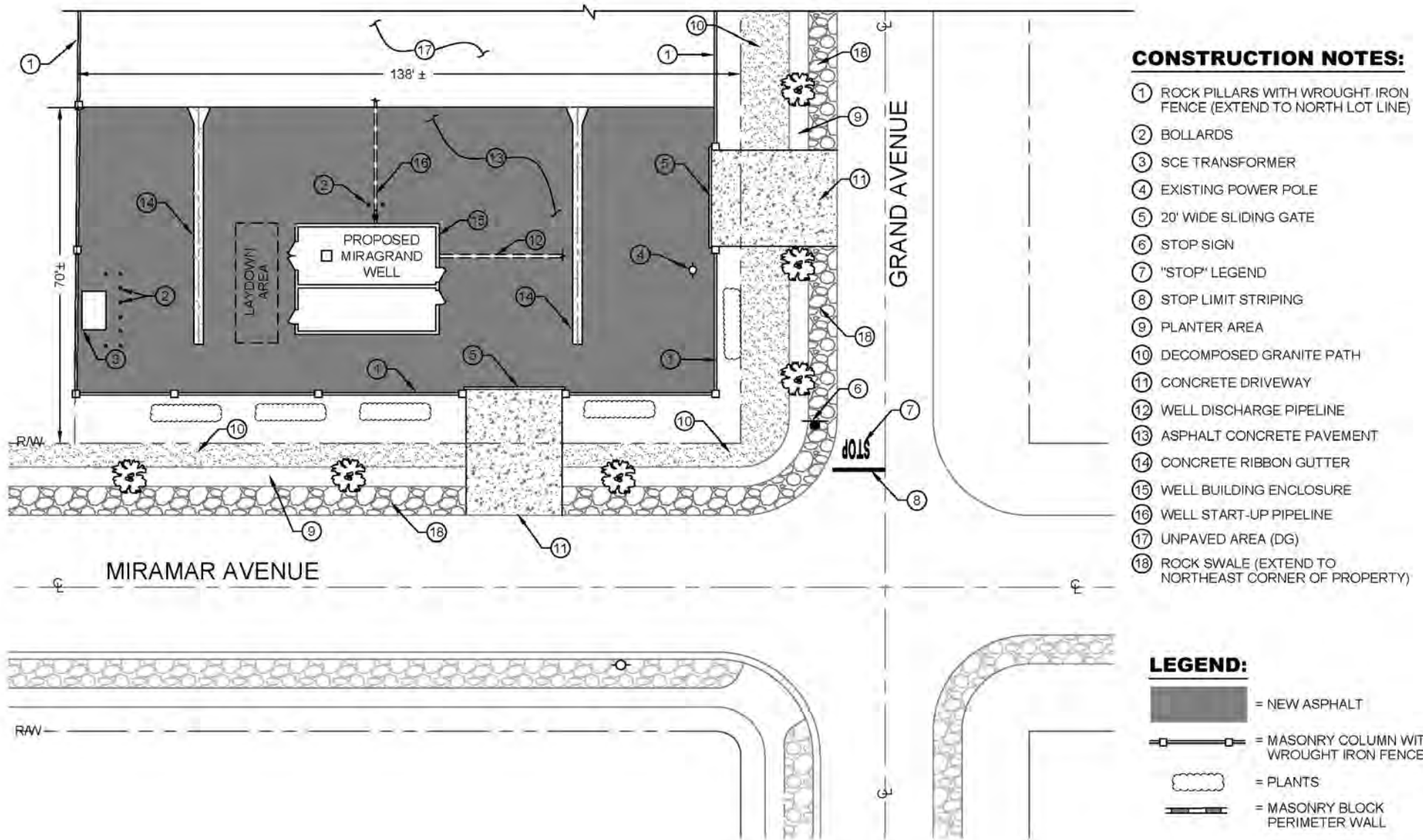

Source: JIG Figure 9



Not to scale

Figure 6  
Conceptual Site Plan

Miragrand Well Site  
TVMWD

[This page intentionally left blank]

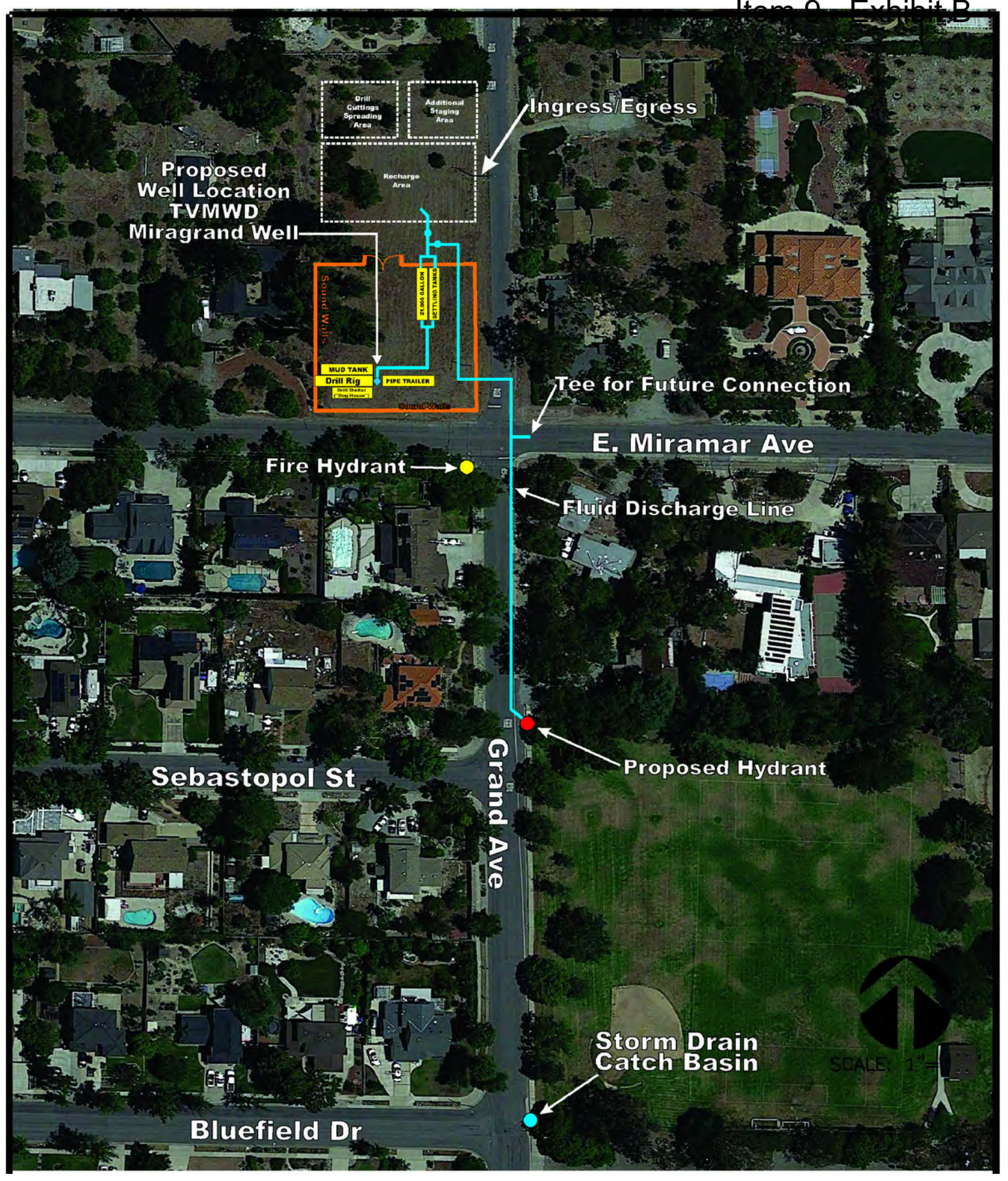

Source: JIG Figure 5

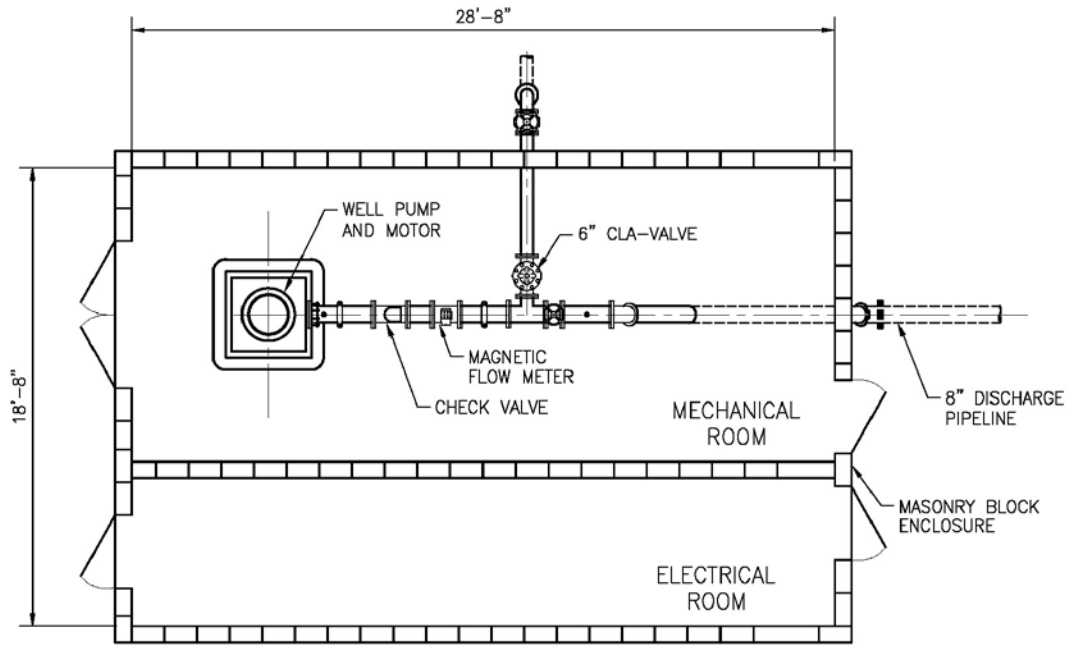

Figure 7  
Discharge Location

Miragrand Well Site  
TVMWD



[This page intentionally left blank]



**PLAN VIEW**  
SCALE: 3/16" = 1'

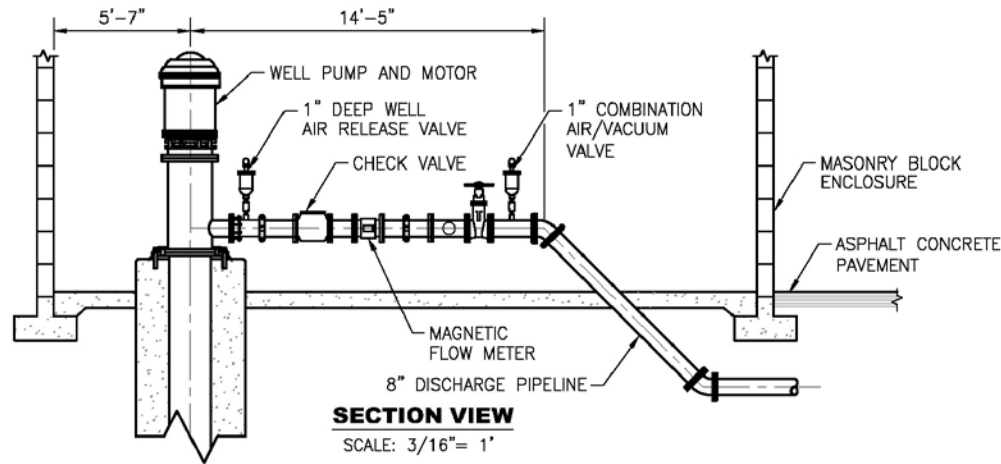

**SECTION VIEW**  
SCALE: 3/16" = 1'

Source: JIG Figure 8



Not to scale

**Figure 9**  
**Well Enclosure Building**

Miragrand Well Site  
TVMWD

[This page intentionally left blank]

GRAND AVENUE

MIRAMAR AVENUE

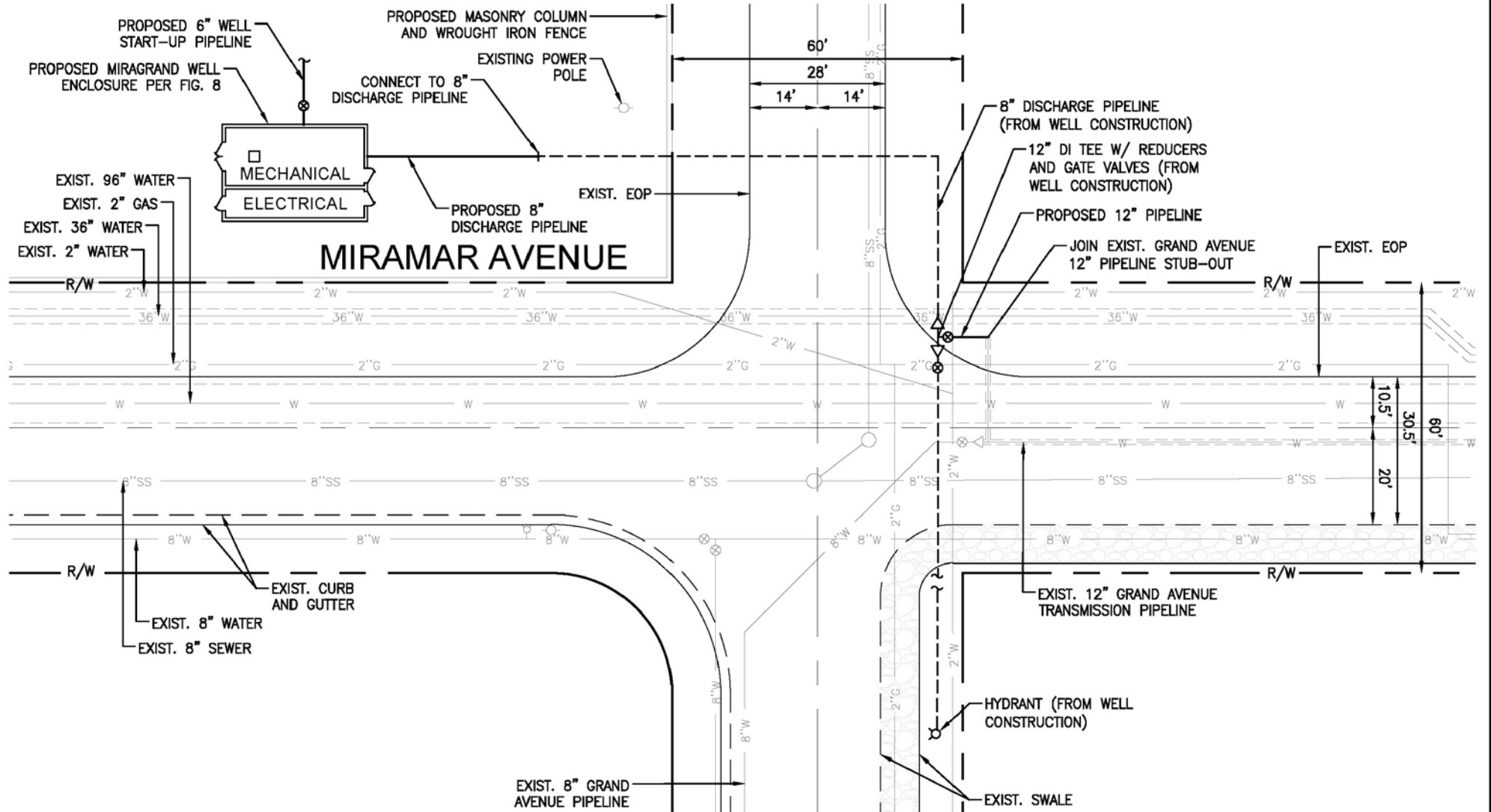

Source: JIG Figure 10



Not to scale

Figure 8  
Proposed Connection

Miragrand Well Site  
TVMWD

[This page intentionally left blank]

### 3. Environmental Evaluation

#### 3.01 Environmental Factors Potentially Affected

The environmental factors checked below would be potentially affected by this project, involving at least one impact requiring mitigation to be reduced to a level that is less than significant as indicated in the checklist on the following pages.

- |  |   |   |
|--|---|---|
| <input type="checkbox"/> Aesthetics                          | <input type="checkbox"/> Agricultural / Forest Resources      | <input checked="" type="checkbox"/> Air Quality               |
| <input type="checkbox"/> Biological Resources                | <input checked="" type="checkbox"/> Cultural Resources        | <input type="checkbox"/> Geology / Soils                      |
| <input type="checkbox"/> Greenhouse Gas Emissions            | <input type="checkbox"/> Hazards / Hazardous Materials        | <input checked="" type="checkbox"/> Hydrology / Water Quality |
| <input type="checkbox"/> Land Use / Planning                 | <input type="checkbox"/> Mineral Resources                    | <input checked="" type="checkbox"/> Noise                     |
| <input type="checkbox"/> Population / Housing                | <input type="checkbox"/> Public Services                      | <input type="checkbox"/> Recreation                           |
| <input checked="" type="checkbox"/> Transportation / Traffic | <input checked="" type="checkbox"/> Tribal Cultural Resources | <input type="checkbox"/> Utilities / Service Systems          |
| <input type="checkbox"/> Mandatory Findings of Significance  |   |   |

#### 3.02 Determination (To be completed by the Lead Agency)

On the basis of this initial evaluation, the following finding is made:

	The proposed project COULD NOT have a significant effect on the environment, and a NEGATIVE DECLARATION will be prepared.
X	Although the proposed project could have a significant effect on the environment, there will not be a significant effect in this case because revisions in the project have been made by or agreed to by the project proponent. A MITIGATED NEGATIVE DECLARATION will be prepared.
	The proposed project MAY have a significant effect on the environment, and an ENVIRONMENTAL IMPACT REPORT is required.
	The proposed project MAY have a "potentially significant impact" or "potentially significant unless mitigated" impact on the environment, but at least one effect 1) has been adequately analyzed in an earlier document pursuant to applicable legal standards, and 2) has been addressed by mitigation measures based on the earlier analysis as described on attached sheets. An ENVIRONMENTAL IMPACT REPORT is required, but it must analyze only the effects that remain to be addressed.
	Although the proposed project could have a significant effect on the environment, because all potentially significant effects (a) have been analyzed adequately in an earlier EIR or NEGATIVE DECLARATION pursuant to applicable standards, and (b) have been avoided or mitigated pursuant to that earlier EIR or NEGATIVE DECLARATION, including revisions or mitigation measures that are imposed upon the proposed project, nothing further is required.

\_\_\_\_\_  
Signature

\_\_\_\_\_  
Date

### 3.03 Evaluating Environmental Impacts

- 1) A brief explanation is required for all answers including "No Impact" answers that are adequately supported by the information sources a lead agency cites in the parentheses following each question. A "No Impact" answer is adequately supported if the referenced information sources show that the impact simply does not apply to projects like the one involved (e.g. the project falls outside a fault rupture zone). A "No Impact" answer should be explained where it is based on project-specific factors as well as general standards (e.g. the project would not expose sensitive receptors to pollutants, based on a project-specific screening analysis).
- 2) All answers must take account of the whole action involved, including off-site as well as on-site, cumulative as well as project-level, indirect as well as direct, and construction as well as operational impacts.
- 3) Once the lead agency has determined that a particular physical impact may occur, then the checklist answers must indicate whether the impact is potentially significant, less than significant with mitigation, or less than significant. "Potentially Significant Impact" is appropriate if there is substantial evidence that an effect is significant. If there are one or more "Potentially Significant Impact" entries when the determination is made, an EIR is required.
- 4) "Negative Declaration: Less Than Significant With Mitigation Incorporated" applies where the incorporation of mitigation measures has reduced an effect from "Potentially Significant Impact" to a "Less than Significant Impact." The lead agency must describe the mitigation measures, and briefly explain how they reduce the effect to a less than significant level (mitigation measures from an earlier analysis document such as a Program EIR may be cross-referenced).
- 5) Earlier analyses may be used where, pursuant to the tiering, program EIR, or other CEQA process, an effect has been adequately analyzed in an earlier EIR or negative declaration. Section 15063(c)(3)(D). In this case, a brief discussion should identify the following:
  - a) Earlier Analyses Used. Identify and state where they are available for review.
  - b) Impacts Adequately Addressed. Identify which effects from the above checklist were within the scope of and adequately analyzed in an earlier document pursuant to applicable legal standards, and state whether such effects were addressed by mitigation measures based on the earlier analysis.
  - c) Mitigation Measures. For effects that are "Less than Significant with Mitigation Measures Incorporated," describe the mitigation measures which were incorporated or refined from the earlier document and the extent to which they address site-specific conditions for the project.

- 6) Lead agencies are encouraged to incorporate into the checklist references to information sources for potential impacts (e.g. general plans, zoning ordinances). Reference to a previously prepared or outside document should, where appropriate, include a reference to the page or pages where the statement is substantiated.
- 7) Supporting Information Sources. A source list should be attached, and other sources used or individuals contacted should be cited in the discussion.
- 8) This is only a suggested form, and lead agencies are free to use different formats; however, lead agencies should normally address the questions from this checklist that are relevant to a project's environmental effects in whatever format is selected.
- 9) The explanation of each issue should identify:
  - a) the significance criteria or threshold, if any, used to evaluate each question; and
  - b) the mitigation measure identified, if any, to reduce the impact to less than significance.



## Environmental Checklist

	Potentially Significant Impact	Less Than Significant with Mitigation Incorporated	Less Than Significant Impact	No Impact
<b>3.1 Aesthetics:</b> Would the project:				
a) Have a substantial adverse effect on a scenic vista?			✓	
b) Substantially damage scenic resources, including, but not limited to, trees, rock outcroppings, and historic buildings within a state scenic highway?				✓
c) In non-urbanized areas, substantially degrade the existing visual character or quality of public views of the site and its surroundings? (Public views are those that are experienced from publicly accessible vantage point) If the project is in an urbanized area, would the project conflict with applicable zoning and other regulations governing scenic quality?			✓	
d) Create a new source of substantial light or glare which would adversely affect day or nighttime views in the area?			✓	

## Discussion

1(a) Have a substantial adverse effect on a scenic vista? **Determination: Less Than Significant Impact.**

Scenic vistas include views of natural features such as topography, watercourses, rock outcroppings, natural vegetation, and historic buildings. The area surrounding the project site is single family residential with mature landscaping including trees. The City of Claremont General Plan does not identify any scenic vistas with the City.

Neither the project site nor the surrounding areas contain any unique visual features that could represent a scenic vista. The streets within the local area provide views of the San Gabriel Mountains that can be interrupted by the mature trees.

The proposed project is a new groundwater well that will have a low profile on the site. The well and related pipeline to connect to the existing water line in Grand Avenue will be underground. The pump and other related project elements will be housed in a low-profile

building, thus would not interrupt views of the mountains. The remaining portion of the site not used as part of the well will be maintained with landscape/hardscape, including the retention of existing trees. The entire one-acre site will be enclosed. Therefore, development the existing undeveloped one-acre site would have a less than significant impact in a scenic vista.

- 1(b) Substantially damage scenic resources, including, but not limited to, trees, rock outcroppings, and historic buildings within a state scenic highway? **Determination: No Impact.**

The project site is not located near any state-designated scenic highways, or highways eligible for designation as a state scenic highway. In addition, the project site does not contain any scenic resources such as trees, rock outcroppings, or historic buildings. There would be no impact to scenic resources or highways.

- 1(c) Substantially degrade the existing visual character or quality of the site and its surroundings? **Determination: Less than Significant Impact.**

The site is routinely graded for weed abatement and was recently (July 2019) graded. Currently, the site is being used as a staging area (storage of construction materials and equipment) for construction of a groundwater production well further south on Grand Avenue. Upon completion of construction, approximately 10,000 square feet of the approximately one-acre site will house a small building surrounded by a block wall on the north and west sides of the well site, and a combination brick/block wall topped with wrought iron fencing on the east (Grand Avenue) and south (Miramar Avenue) sides of the site. Access to the site will be from a rolling gate near the southwest corner of the well site. Sidewalks and landscaping will also be developed along the Grand Avenue and Miramar Avenue sides of the site. The remaining  $\frac{3}{4}$ -acre of the site will be maintained with landscape/hardscape behind the new fence. The hardscape material may consist of gravel, mulch or other cover to reduce the prevalence of weeds and control dust from the undeveloped portion of the site.

The 8-inch pipeline would be installed underground on-site and within Grand Avenue where it will connect to the existing 12-inch Grand Avenue pipeline. Therefore, there would be no impacts to Aesthetics associated with the pipeline portion of the project.

In summary, the proposed project would be designed to be aesthetically pleasing to its surrounding uses and would have a less than significant impact on the existing visual character of the surrounding area.

- 1(d) Create a new source of substantial light or glare which would adversely affect day or nighttime views in the area? **Determination: Less than Significant Impact.**

The project site is located within a single-family neighborhood where nighttime lighting is minimal and limited to security lighting that may be used on individual properties. There

are no street lights in the vicinity of the project site. Nearby residences may be exposed to outdoor night lighting during construction while drilling is proposed to occur over a 15-20 day period when drilling would be 24 hours. All lighting during construction will be directed toward the work area and shielded away from residences, or the street.

During operations, the building would have outdoor security lighting. All exterior lighting (both during construction and operation) would be designed, arranged, installed, directed, shielded, and maintained in such a manner as to minimize light spillover and glare. Therefore, the proposed project would have a less than significant impact regarding new sources of substantial light and glare.

**Mitigation Measures**

None required.

**Impact Conclusions**

No significant adverse impacts were identified or are anticipated, therefore no mitigation measures are required.

	Potentially Significant Impact	Less Than Significant with Mitigation Incorporated	Less Than Significant Impact	No Impact
<p><b>3.2 Agriculture and Forestry Resources:</b>                      In determining whether impacts to agricultural resources are significant environmental effects, lead agencies may refer to the California Agricultural Land Evaluation and Site Assessment Model (1997) prepared by the California Dept. of Conservation as an optional model to use in assessing impacts on agriculture and farmland. In determining whether impacts to forest resources, including timberland, are significant environmental effects, lead agencies may refer to information compiled by the California Department of Forestry and Fire Protection regarding the state's inventory of forest land, including the Forest and Range Assessment Project and the Forest Legacy Assessment project; and forest carbon measurement methodology provided in Forest Protocols adopted by the California Air Resources Board. Would the project:</p>				
<p>a) Convert Prime Farmland, Unique Farmland or Farmland of Statewide Importance (Farmland), as shown on the maps prepared pursuant to the</p>				✓

	Potentially Significant Impact	Less Than Significant with Mitigation Incorporated	Less Than Significant Impact	No Impact
Farmland Mapping and Monitoring Program of the California Resources Agency, to non-agricultural use?				✓
b) Conflict with existing zoning for agricultural use or a Williamson Act contract?				✓
c) Conflict with existing zoning for, or cause rezoning of, forest land (as defined in Public Resources Code section 12220(g)), timberland (as defined by Public Resources Code section 4526), or timberland zoned Timberland Production (as defined by Government Code section 51104(g))?				✓
d) Result in the loss of forest land or conversion of forest land to non-forest use?				✓
e) Involve other changes in the existing environment which, due to their location or nature, could result in conversion of Farmland, to non-agricultural use or conversion of forest land to non-forest use?				✓

**Discussion**

2(a) Convert Prime Farmland, Unique Farmland or Farmland of Statewide Importance (Farmland), as shown on the maps prepared pursuant to the Farmland Mapping and Monitoring Program (FMMP) of the California Resources Agency, to non-agricultural use? **Determination: No Impact.**

The project site is an approximately vacant one-acre site located within an established single family neighborhood in the City of Claremont.

2(b) Conflict with existing zoning for agricultural use or a Williamson Act contract? **Determination: No Impact.**

The project site is not under a Williamson Act contract; has a general plan designation of Residential 2 (R2) 0.1 to 2.0 dwelling units/acre; and is zoned RR 35,000 – Residential, 1 gross acre/dwelling unit. Therefore, there will be no conflict with existing zoning or a Williamson Act contract.

2(c) Conflict with existing zoning for, or cause rezoning of, forest land (as defined in Public Resources Code section 12220(g)), timberland (as defined by Public Resources Code

section 4526), or timberland zoned Timberland Production (as defined by Government Code section 51104(g))? **Determination: No Impact.**

The project site is not located in a forest area.

2(d) Result in the loss of forest land or conversion of forest land to non-forest use? **Determination: No Impact.**

The project site is not located in a forest area.

2(e) Involve other changes in the existing environment which, due to their location or nature, could result in conversion of Farmland, to non-agricultural use or conversion of forest land to non-forest use? **Determination: No Impact.**

See responses to 2(a) through 2(d) above.

**Mitigation Measures**

No impacts have been identified therefore no mitigation measures are required.

**Impact Conclusions**

No mitigation measures are required as the proposed project is not in agriculture or located on forest land.

	Potentially Significant Impact	Less Than Significant with Mitigation Incorporated	Less Than Significant Impact	No Impact
<b>3.3 Air Quality:</b> Where available, the significance criteria established by the applicable air quality management or air pollution control district may be relied upon to make the following determinations. Would the project:				
a) Conflict with or obstruct implementation of the applicable air quality plan?				✓
b) Result in a cumulatively considerable net increase of any criteria pollutant for which the project region is non-attainment under an applicable federal or state ambient air quality standard?		✓		
c) Expose sensitive receptors to substantial pollutant concentrations?		✓		
d) Result in other emissions (such as those leading to odors adversely affecting a substantial number of people)?			✓	

## DISCUSSION

- 3(a) Conflict with or obstruct implementation of the applicable air quality plan?  
**Determination: No Impact.**

A project may be inconsistent with the South Coast Air Quality Management District's (SCAQMD) Air Quality Management Plan (AQMP) if it would generate population, housing, or employment growth exceeding the forecasts used in the development of the AQMP. The proposed project includes the construction of a new well, well pump and pipeline. TVMWD has proposed the project in order to meet the water demands of its existing and planned customers. The project does not include new housing or businesses, nor would operation and maintenance of the proposed project require new employees; therefore, the project would not generate population, housing, or employment growth. As a result, the project would not exceed the Southern California Association of Governments' (SCAG) projected growth forecasts, which underlie the emissions forecasts in the 2016 AQMP, the most recent AQMP. Therefore, the project would not conflict with or obstruct implementation of the AQMP. No impact would occur.

- 3(b) Violate any air quality standard or contribute substantially to an existing or projected air quality violation? **Determination: Less Than Significant Impact with Mitigation Incorporated.**

### Air Quality Standards and Attainment

The project area is within the South Coast Air Basin (Air Basin) which is bounded by the Pacific Ocean to the west and the San Gabriel, San Bernardino, and San Jacinto Mountains to the north and east, and includes all of Orange County and the non-desert portions of Los Angeles, Riverside, and San Bernardino Counties, in addition to the San Gorgonio Pass area in Riverside County. The Air Basin is under the regulatory jurisdiction of SCAQMD. The local air quality management agency is required to monitor air pollutant levels to ensure that National Ambient Air Quality Standards (NAAQS) and California Ambient Air Quality Standards (CAAQS) are met and, if they are not met, to develop strategies to meet the standards.

Depending on whether the standards are being met, the Air Basin is classified as being in "attainment" or "nonattainment" for air quality. SCAQMD's 2016 AQMP assesses the attainment status of the Air Basin. The NAAQS and CAAQS attainment statuses for the Air Basin are listed in Table 2A, *State and Federal Ambient Air Quality Standards*. Table 2B, *South Coast Air Basin Attainment Status*, shows that the Air Basin is in nonattainment for the federal standards for ozone and particulate matter 2.5 microns or less in diameter (PM<sub>2.5</sub>) and the State standards for ozone, particulate matter 10 microns or less in diameter (PM<sub>10</sub>), and PM<sub>2.5</sub>. Areas of the Air Basin located in Los Angeles County are also in nonattainment for lead. The Air Basin is designated unclassifiable or in attainment for all other federal and State standards.

**Table 2A State and Federal Ambient Air Quality Standards**

Pollutant	Averaging Time	CAAQS	NAAQS	
			Primary	Secondary
Ozone (O <sub>3</sub> )	8-Hour	0.070 ppm (137 µg/m <sup>3</sup> )	0.075 ppm (147 µg/m <sup>3</sup> )	Same as Primary
	1-Hour	0.09 ppm (180 µg/m <sup>3</sup> )	N/A	N/A
Carbon Monoxide (CO)	8-Hour	9.0 ppm (10 mg/m <sup>3</sup> )	9 ppm (10 mg/m <sup>3</sup> )	N/A
	1-Hour	20 ppm (23 mg/m <sup>3</sup> )	35 ppm (40 mg/m <sup>3</sup> )	N/A
Nitrogen Dioxide (NO <sub>2</sub> )	Annual	0.030 ppm (57 µg/m <sup>3</sup> )	0.053 ppm (100 µg/m <sup>3</sup> )	Same as Primary
	1-Hour	0.18 ppm (339 µg/m <sup>3</sup> )	100 ppb (188 µg/m <sup>3</sup> )	N/A
Sulfur Dioxide (SO <sub>2</sub> )	24-Hour	0.04 ppm (105 µg/m <sup>3</sup> )	N/A	N/A
	3-Hour	N/A	N/A	0.5 ppm (1300 µg/m <sup>3</sup> )
	1-Hour	0.25 ppm (655 µg/m <sup>3</sup> )	75 ppb (196 µg/m <sup>3</sup> )	N/A
Particulate Matter (PM <sub>10</sub> )	AAM	20 µg/m <sup>3</sup>	N/A	N/A
	24-Hour	50 µg/m <sup>3</sup>	150 µg/m <sup>3</sup>	Same as Primary
Particulate Matter (PM <sub>2.5</sub> )	AAM	12 µg/m <sup>3</sup>	15.0 µg/m <sup>3</sup>	Same as Primary
	24-Hour	N/A*	35 µg/m <sup>3</sup>	Same as Primary
Lead (Pb)	Quarterly	N/A	1.5 µg/m <sup>3</sup>	Same as Primary
	Monthly	1.5 µg/m <sup>3</sup>	N/A	N/A
	3-Month	N/A	0.15 µg/m <sup>3</sup>	Same as Primary
Sulfates	24-Hour	25 µg/m <sup>3</sup>	N/A	N/A
Hydrogen Sulfide	1-hour	0.03 ppm (42 µg/m <sup>3</sup> )	N/A	N/A
Vinyl Chloride	24-hour	0.01 ppm (26 µg/m <sup>3</sup> )	N/A	N/A

Source: California Air Resources Board, *Ambient Air Quality Standards (California and Federal)*, Available: <http://www.arb.ca.gov/research/aaqs/aaqs2.pdf> [Last updated May 4, 2016].

## Notes:

ppm = parts per million (by volume)

N/A = Not applicable

µg/m<sup>3</sup> = micrograms per cubic meter

mg/m<sup>3</sup> = milligrams per cubic meter

AAM = Annual arithmetic mean

\* There is no separate 24-hour PM 2.5 standard in California; however, the U.S. EPA promulgated at 24-hour PM 2.5 ambient air quality standard of 35 µg/m<sup>3</sup>.

**Table 2B South Coast Air Basin Attainment Status**

Pollutant	Standard	Designation
1-Hour Ozone	NAAQS CAAQS	Nonattainment (Extreme) Nonattainment
8-Hour Ozone	NAAQS CAAQS	Nonattainment (Extreme) <sup>1</sup> Nonattainment
CO	NAAQS CAAQS	Attainment (Maintenance) Attainment
NO <sub>2</sub>	NAAQS CAAQS	Unclassifiable/Attainment Attainment
SO <sub>2</sub>	NAAQS CAAQS	Designations ending/Unclassifiable/Attainment <sup>2</sup> Attainment
PM <sub>10</sub>	NAAQS CAAQS	Attainment (Maintenance) Nonattainment
PM <sub>2.5</sub> (24-hour) PM <sub>2.5</sub> (Annual)	NAAQS CAAQS	Nonattainment (Serious) Nonattainment
Lead	NAAQS CAAQS	Nonattainment (Partial) <sup>3</sup> Attainment
Hydrogen Sulfide	CAAQS	Unclassified <sup>4</sup>
Sulfates	CAAQS	Attainment

Source: NAAQS: National Ambient Air Quality Standards; CAAQS: California Ambient Air Quality Standards

## Notes:

1. Designated Nonattainment (Extreme) for the 1997 and 2008 8-Hour Ozone NAAQS. Designation is pending for the 2015 8-Hour Ozone NAAQS, but Nonattainment (Extreme) is expected.
2. Designated Unclassifiable/Attainment for the Annual SO<sub>2</sub> NAAQS. Designation is pending for the 1-Hour SO<sub>2</sub> NAAQS, but Unclassifiable/Attainment in expected.
3. Designated Nonattainment (Partial) for the Los Angeles County portion of the SCAB only for near-source monitors. Los Angeles County is expected to remain in attainment based on current monitoring data, and the attainment re-designation request is pending.
4. SCAQMD began monitoring hydrogen sulfide in the southeastern Coachella Valley in November 2013 due to odor events related to the Salton Sea; three full years of data are not yet available for a State designation.

Thus, the Air Basin currently exceeds several State and federal ambient air quality standards and is required to implement strategies that would reduce pollutant levels to recognized acceptable standards.

SCAQMD has adopted an AQMP that provides a strategy for the attainment of State and federal air quality standards. As discussed in Section 3(a) above, the proposed project would not conflict with the AQMP and therefore, the project would not result in a significant impact on the environment.



### Air Quality Management

Under State law, SCAQMD is required to prepare a plan for air quality improvement for pollutants for which the District is in nonattainment. SCAQMD has adopted an AQMP that provides a strategy for the attainment of State and federal air quality standards. The AQMP is updated every three years with each iteration representing an update of the previous plan, and that has a 20-year horizon. The latest AQMP, the 2016 AQMP, was adopted on March 3, 2017. The 2016 AQMP incorporates new scientific data and notable regulatory actions that have occurred since adoption of the 2012 AQMP, including the approval of the federal 8-hour ozone standard of 0.070 parts per million (ppm) that was finalized in 2015. The 2016 AQMP builds upon the approaches taken in the 2012 AQMP for the attainment of federal PM and ozone standards and highlights the significant amount of reductions to be achieved. It emphasizes the need for interagency planning to identify additional strategies to achieve reductions within the timeframes allowed under the federal Clean Air Act (CAA), especially in the area of mobile sources. The 2016 AQMP also includes a discussion of emerging issues and opportunities, such as fugitive toxic particulate emissions, zero-emission mobile source control strategies, and the interacting dynamics among climate, energy, and air pollution. The 2016 AQMP also includes attainment demonstrations of the new federal 8-hour ozone standard and vehicle miles travelled (VMT) emissions offsets, as per recent United States Environmental Protection Agency (EPA) requirements.

### Air Emission Thresholds

SCAQMD provides numerical thresholds to analyze the significance of a project's construction and operational emissions impacts on regional air quality. These thresholds are designed so a project that is consistent with the thresholds would not have an individually or cumulatively significant impact to the SCAB's air quality.

#### *Thresholds of Significance for Construction:*

- 75 pounds per day of ROG
- 100 pounds per day of NO<sub>x</sub>
- 550 pounds per day of CO
- 150 pounds per day of SO<sub>x</sub>
- 150 pounds per day of PM<sub>10</sub>
- 55 pounds per day of PM<sub>2.5</sub>

#### *Thresholds of Significance for Operations:*

- 55 pounds per day of ROG
- 55 pounds per day of NO<sub>x</sub>
- 550 pounds per day of CO
- 150 pounds per day of SO<sub>x</sub>
- 150 pounds per day of PM<sub>10</sub>
- 55 pounds per day of PM<sub>2.5</sub>

In an effort to monitor the various concentrations of air pollutants throughout the Air Basin, SCAQMD has divided the region into 38 source receptor areas (SRAs) in which over 30 monitoring stations operate. The project site is located within SRA 10.

In addition to the listed thresholds, SCAQMD has developed Localized Significance Thresholds (LSTs) in response to the Governing Board's Environmental Justice Enhancement Initiative (1-4), which was prepared to update the CEQA Air Quality Handbook. LSTs were devised in response to concern regarding exposure of individuals to criteria pollutants in local communities and have been developed for nitrogen oxides (NO<sub>x</sub>), carbon monoxide (CO), PM<sub>10</sub>, and PM<sub>2.5</sub>. LSTs represent the maximum emissions from a project that will not cause or contribute to an air quality exceedance of the most stringent applicable federal or State ambient air quality standard at the nearest sensitive receptor, taking into consideration ambient concentrations in each SRA, distance to the sensitive receptor, and project size. LSTs only apply to emissions within a fixed stationary location and are not applicable to mobile sources, such as cars on a roadway. According to the 2008 SCAQMD Final Localized Significant Thresholds Methodology, the use of LSTs is voluntary, to be implemented at the discretion of local agencies.

The project site is located in SRA 10, Pomona/Walnut Valley and is approximately 1.0 acre in size. LSTs have been developed for emissions within construction areas up to five acres in size. SCAQMD provides lookup tables for sites that measure up to one, two, or five acres. Pursuant to SCAQMD guidance, a regression was conducted to calculate the LSTs for a 1.0-acre site. LSTs are provided for receptors at a distance of 25 to 500 meters (82 to 1,640 feet) from the project site boundary. The closest sensitive receptors to the project site are residences located adjacent to the project site. According to the LST methodology, projects with boundaries closer than 25 meters (82 feet) to the nearest receptor should use the LSTs for receptors located at 25 meters. The applicable LSTs for construction on a 1.0-acre site in SRA 10 for a receptor at a distance of 25 meters are shown in Table 3, *Localized Significance Thresholds (Pounds Per Day)*.

The project would generate short-term emissions associated with project construction and long-term emissions associated with operation and maintenance of the pump station. Construction and operational emissions associated with the pump station were estimated using the California Emissions Estimator Model (CalEEMod) version 2016.3.2. CalEEMod was developed by the SCAQMD and is used by jurisdictions throughout the State to quantify criteria pollutant emissions.

For the purposes of modeling, the analysis relied upon the conservative assumptions included in Section 2.3, *Project Description*.

**Table 3 Localized Significance Thresholds (Pounds Per Day)**

Source	NO <sub>x</sub>	CO	PM10 <sup>1</sup>		PM2.5 <sup>1</sup>	
Allowable Emissions for a 1.0-acre Site in SRA 10 for a Receptor at 25 Meters	103	612	12 <sup>2</sup>	4 <sup>3</sup>	3 <sup>2</sup>	1 <sup>3</sup>

Sources: SCAQMD Final Localized Significance Threshold Methodology; SCAQMD Mass Rate Look-up Tables for 1-acre site in SRA No. 10, distance of 25 meters.

Note:

1. PM10 and PM2.5 emissions are separated into construction and operational thresholds in accordance with the SCAQMD Mass Rate LST Look-up Tables. Per LST Methodology, mobile source emissions do not need to be included except for land use emissions and on-site vehicle emissions. It is estimated that approximately 10 percent of mobile emissions will occur on the project site.
2. Construction emissions LST.
3. Operational emissions LST.

### Construction Emissions

Project construction would generate temporary air pollutant emissions associated with fugitive dust and exhaust emissions from heavy construction vehicles. The site preparation and excavation/shoring phases of the project would involve the largest use of heavy equipment and generation of fugitive dust. Construction of the well and pump station is anticipated to be completed in four months and construction of the pipeline is anticipated to be completed in four months, for a total of eight months of construction (worst case assumption).

Table 4, *Construction Emissions – Well & Pump Station (Pounds Per Day)*, and Table 5, *Construction Emissions – Pipeline (Pounds Per Day)*, summarize maximum daily pollutant emissions during construction of the project. As shown in these tables, project construction emissions would not exceed SCAQMD's regional thresholds or LSTs. Therefore, impacts to regional air quality and local receptors due to construction emissions would be less than significant.

### Operational Emissions

Operation of the proposed well and pump station would require approximately 602,250 kWh of electricity per year for pumping groundwater. CalEEMod does not calculate or attribute emissions of criteria pollutants from electricity supplied to individual projects because fossil fuel power plants are existing stationary sources permitted by air districts and/or the EPA, and they are subject to local, State and federal control measures. Criteria pollutant emissions from power plants are associated with the power plants themselves, and not individual projects or electricity users. Thus, no emissions associated with operation of the pump were modeled.

The primary source of operational emissions that can be modeled would be operator visits to the well and pump station for visual inspection, sampling, maintenance activities, and as-needed repairs (modeled 1 trip a week as a worst-case assumption).

**Table 4 Construction Emissions – Well & Pump Station (Pounds Per Day)**

Source/Phase <sup>1,2</sup>	ROG	NOx	CO	SO2	PM10	PM2.5
Site Preparation	1.5	16.1	9.5	0.0	2.4	1.5
Grading	1.6	15.8	10.2	0.0	2.4	1.5
Building Construction	4.4	45	32.5	0.0	2.3	2.1
Paving	2.1	19.6	16.4	0.0	1.0	0.9
Architectural Coating	2.0	1.7	1.8	0.0	0.1	0.1
<b>Highest Value (lbs/day)<sup>3</sup></b>	<b>4.4</b>	<b>19.6</b>	<b>32.5</b>	<b>0.0</b>	<b>2.4</b>	<b>2.1</b>
SCAQMD Threshold	75	100	550	150	150	55
LST Threshold	---	103	612	---	12	4
<b>Significant</b>	<b>No</b>	<b>No</b>	<b>No</b>	<b>No</b>	<b>No</b>	<b>No</b>

Source: CalEEMod 2016.3.2.

Notes:

1. Phases don't overlap and represent the highest concentration.
2. Additional pieces of construction equipment were added in the model to allow flexibility to the contractor and present a worst-case assumption (i.e. Forklifts, Cranes, Industrial Saws, etc.).
3. Emissions presented are the highest of the winter and summer modeled emissions. Data is sourced from "mitigated" results, which include measures that will be implemented during project construction, such as watering of soils during construction required under SCAQMD Rule 403.

**Table 5 Construction Emissions – Pipeline (Pounds Per Day)**

Source/Phase <sup>1,2</sup>	ROG	NOx	CO	SO2	PM10	PM2.5
Construction	2.6	19.6	17.8	0.0	1.1	1.0
Paving	1.4	8.5	8.9	0.0	0.6	0.5
<b>Highest Value (lbs/day)<sup>3</sup></b>	<b>2.6</b>	<b>19.6</b>	<b>17.8</b>	<b>0.0</b>	<b>1.1</b>	<b>1.0</b>
SCAQMD Threshold	75	100	550	150	150	55
LST Threshold	---	103	612	---	12	4
<b>Significant</b>	<b>No</b>	<b>No</b>	<b>No</b>	<b>No</b>	<b>No</b>	<b>No</b>

Source: CalEEMod 2016.3.2.

Notes:

1. Phases don't overlap and represent the highest concentration.
2. Additional pieces of construction equipment were added in the model to allow flexibility to the contractor and present a worst-case assumption (i.e. Forklifts, Cranes, Industrial Saws, etc.).
3. Emissions presented are the highest of the winter and summer modeled emissions. Emission data is sourced from "mitigated" results, which include measures that will be implemented during project construction, such as watering of soils during construction required under SCAQMD Rule 403.

CalEEMod calculates emissions of criteria pollutants from individual projects based on mobile sources (vehicles) and on-site emissions sources, such as fuel combustion by off-road equipment (i.e., the loader/dozer). Table 6, *Operational Emissions (Pounds Per Day)*, summarizes maximum daily pollutant emissions during operation of the project.

**Table 6 Operational Emissions (Pounds Per Day)**

Source	ROG	NOx	CO	S02	PM10	PM2.5
Area	0.02	0.0	0.0	0.0	0.0	0.0
Energy	0.0	0.0	0.0	0.0	0.0	0.0
Mobile	0.0	0.0	0.01	0.0	0.02	0.0
<b>Total Value (lbs/day)<sup>1</sup></b>	<b>0.02</b>	<b>0.0</b>	<b>0.01</b>	<b>0.0</b>	<b>0.02</b>	<b>0.0</b>
SCAQMD Threshold	55	55	550	150	150	55
<b>Significant</b>	<b>No</b>	<b>No</b>	<b>No</b>	<b>No</b>	<b>No</b>	<b>No</b>

Source: CalEEMod 2016.3.2,

Notes:

1. Emissions presented are the highest of the winter and summer modeled emissions.

As shown in Table 6, operational emissions from the proposed project would not exceed SCAQMD thresholds for any criteria pollutant. Therefore, operational emissions would have a less than significant impact.

3(c) Result in a cumulatively considerable net increase of any criteria pollutant for which the project region is non-attainment under an applicable federal or state ambient air quality standard (including releasing emissions which exceed quantitative thresholds for ozone precursors)? **Determination: Less Than Significant Impact with Mitigation Incorporated.**

Certain population groups, such as children, the elderly, and people with health problems, are particularly sensitive to air pollution. Sensitive receptors are defined as land uses that are more likely to be used by these population groups and include health care facilities, retirement homes, school and playground facilities, and residential areas. The project site is located adjacent to a residential neighborhood.

As discussed under item (3b), the project's construction and operational emissions would not exceed the SCAQMD regional thresholds or LSTs, which are designed to be protective of public health.

Traffic-congested roadways and intersections have the potential for the generation of localized CO levels (i.e., CO hotspots). In general, CO hotspots occur in areas with poor

circulation or areas with heavy traffic. This incremental increase in traffic volumes would not significantly impact congestion on local roadways. Therefore, the project would not result in CO hotspots on adjacent roadways. Additionally, these trips would generally not occur during peak travel periods when most congestion occurs. The project would not expose sensitive receptors to substantial pollutant concentrations, and impacts would be less than significant.

3(d) Expose sensitive receptors to substantial pollutant concentrations? **Determination: Less Than Significant Impact.**

During construction, the project would generate oil and diesel fuel odors from use of heavy equipment as well as odors related to asphalt paving. Construction-related odors associated with construction of the well and pump station would be limited to approximately four months, but would not necessarily be consecutive as the construction includes well drilling, site development (new pumphouse, perimeter wall, site paving, construction of the pipeline, and street repair after the pipeline is in place below grade. The asphalt paving phase is anticipated to be less than one month in duration. The adjacent receptors would only be exposed to construction-generated odors for a short period of time. Therefore, construction-related odor impacts would be less than significant.

Operation of the project would not generate objectionable odors as the water pipeline would be located entirely below the ground surface and would have a low potential to generate odors, and the pump station would be electrically-powered and enclosed in a pump house structure. As a result, impacts would be less than significant.

### Mitigation Measures

The following mitigation measures were assumed to be implemented in the evaluation of the project using CalEEMod.

AQ-1 Construction contractors shall adhere to applicable measures set forth in SCAQMD Rule 403 including, but not limited to:

- All clearing, grading, earth-moving, or excavation activities shall cease when winds exceed 25 mph per SCAQMD guidelines in order to limit fugitive dust emissions.
- The contractor shall ensure that all disturbed unpaved roads and disturbed areas within the project site are watered at least three (3) times daily during dry weather. Watering, with complete coverage of disturbed areas, shall occur at least three times a day, preferably in the mid-morning, afternoon, and after work is done for the day.
- The contractor shall ensure that traffic speeds at the project site areas are limited to 15 miles per hour or less.

**Impact Conclusions**

Tables 4 and 5 summarize maximum daily pollutant emissions during construction of the project assuming compliance with SCAQMD Rule 403 regarding fugitive dust, and EPA/CARB requirements for compliance with Tier 4 emissions standards or equivalent. As shown in these tables, project construction emissions would not exceed SCAQMD’s regional thresholds or LSTs. Therefore, impacts to regional air quality and local receptors due to construction emissions would be less than significant.

There were no significant impacts associated with operation of the site once construction has been completed.

	Potentially Significant Impact	Less Than Significant with Mitigation Incorporated	Less Than Significant Impact	No Impact
<b>3.4 Biological Resources:</b> Would the project:				
a) Have a substantial adverse effect, either directly or through habitat modifications, on any species identified as a candidate, sensitive, or special status species in local or regional plans, policies, or regulations, or by the California Department of Fish and Wildlife or U.S. Fish and Wildlife Service?				✓
b) Have a substantial adverse effect on any riparian habitat or other sensitive natural community identified in local or regional plans, policies, regulations or by the California Department of Fish and Wildlife or U.S. Fish and Wildlife Service?				✓
c) Have a substantial adverse effect on federally protected wetlands as defined by Section 404 of the Clean Water Act (including, but not limited to, marsh, vernal pool, coastal, etc.) through direct removal, filling, hydrological interruption, or other means?				✓

	Potentially Significant Impact	Less Than Significant with Mitigation Incorporated	Less Than Significant Impact	No Impact
d) Interfere substantially with the movement of any native resident or migratory fish or wildlife species or with established native resident or migratory wildlife corridors, or impede the use of native wildlife nursery sites?				✓
e) Conflict with any local policies or ordinances protecting biological resources, such as a tree preservation policy or ordinance?				✓
f) Conflict with the provisions of an adopted Habitat Conservation Plan, Natural Community Conservation Plan, or other approved local, regional, or state habitat conservation plan?				✓

### Discussion

4(a) Have a substantial adverse effect, either directly or through habitat modifications, on any species identified as a candidate, sensitive, or special status species in local or regional plans, policies, or regulations, or by the California Department of Fish and Wildlife or U.S. Fish and Wildlife Service? **Determination: No Impact.**

The approximately one-acre vacant project site is located in a residential neighborhood surrounded by single-family homes and paved streets. As part of on-going maintenance of sites, TVMWD routinely disks and removes vegetation from the site to control weeds. This task was completed again in mid-2019 so that the site is currently vacant and there is no vegetation that could provide habitat for any species. The site is also currently being used as a staging area for the construction of a new well site on Grand Avenue south of the project site. Staging includes parking vehicles and equipment and stockpiling material. Upon completion of well development at the project site, the remaining area that is not a part of the well will be improved with landscape/hardscape to reduce the potential for the site to become overgrown again. Therefore, development of the project site would not have a substantial adverse effect on plant or wildlife species.

4(b) Have a substantial adverse effect on any riparian habitat or other sensitive natural community identified in local or regional plans, policies, regulations or by the California Department of Fish and Wildlife or U.S. Fish and Wildlife Service? **Determination: No Impact.**



The approximately one-acre project site does not contain any water features that would be considered riparian habitat and does not contain any sensitive natural communities. Therefore, development of the well site would not have a substantial adverse effect on plant or wildlife species.

- 4(c) Have a substantial adverse effect on federally protected wetlands as defined by Section 404 of the Clean Water Act (including, but not limited to, marsh, vernal pool, coastal, etc.) through direct removal, filling, hydrological interruption, or other means? **Determination: No Impact.**

The project site does not contain any wetlands.

- 4(d) Interfere substantially with the movement of any native resident or migratory fish or wildlife species or with established native resident or migratory wildlife corridors, or impede the use of native wildlife nursery sites? **Determination: No Impact.**

The approximately one-acre vacant project site is located in a residential neighborhood surrounded by single-family homes and paved streets. As part of on-going maintenance of sites, TVMWD routinely disks and removes vegetation from the site to control weeds. This task was completed again in mid-2019 so that the site is currently vacant (except for the temporary staging of vehicles, equipment and material) and there is no vegetation that could provide habitat for any species. Therefore, development of the well site would not interfere substantially with established native resident or migratory wildlife corridors or impede the use of native wildlife nursery sites.

- 4(e) Conflict with any local policies or ordinances protecting biological resources, such as a tree preservation policy or ordinance? **Determination: No Impact.**

The project does not include the removal of any trees. Existing trees located on the northerly  $\frac{3}{4}$  of the site and will remain and be incorporated into the landscape design of that portion of the site.

- 4(f) Conflict with the provisions of an adopted Habitat Conservation Plan, Natural Community Conservation Plan, or other approved local, regional, or state habitat conservation plan? **Determination: No Impact.**

The one-acre project site has a general plan designation of Residential 2 (R2) 0.1 to 2.0 dwelling units/acre; and is zoned RR 35,000 – Residential, 1 gross acre/dwelling unit. Therefore, there will be no conflict with the provisions of an adopted habitat conservation plan.

### Mitigation Measures

No impacts have been identified therefore no mitigation measures are required.

Impact Conclusions

Not applicable.

	Potentially Significant Impact	Less Than Significant with Mitigation Incorporated	Less Than Significant Impact	No Impact
<b>3.5 Cultural Resources:</b> Would the project:				
a) Cause a substantial adverse change in the significance of a historical resource as defined in Section 15064.5?		✓		
b) Cause a substantial adverse change in the significance of an archaeological resource pursuant to Section 15064.5?		✓		
c) Disturb any human remains, including those interred outside of formal cemeteries?		✓		

Discussion

5(a) Cause a substantial adverse change in the significance of a historical resource as defined in Section 15064.5? and

5(b) Cause a substantial adverse change in the significance of an archaeological resource pursuant to Section 15064.5? **Determination: Less Than Significant Impact with Mitigation Incorporated.**

Prehistoric Context

The earliest evidence of human occupation in inland southern California was discovered below the surface of an alluvial fan in the northern portion of the Lakeview Mountains, overlooking the San Jacinto Valley, with radiocarbon dates clustering around 9,500 B.P. (before present). Another site found near the shoreline of Lake Elsinore, close to the confluence of Temescal Wash and the San Jacinto River, yielded radiocarbon dates between 8,000 and 9,000 B.P. Additional sites with isolated Archaic dart points, bifaces, and other associated lithic artifacts from the same age range have been found in the nearby Cajon Pass area, typically atop knolls with good viewsheds.

The cultural history of southern California has been summarized into numerous chronologies. Although the beginning and ending dates of different cultural horizons vary regionally, the general framework of the prehistory of inland Southern California can be divided into three primary periods:

- Paleoindian Period (ca. 18,000-9,000 B.P.): Native peoples of this period created fluted spearhead bases designed to be hafted to wooden shafts. The distinctive method of

thinning bifaces and spearhead preforms by removing long, linear flakes, leaves diagnostic Paleoindian markers at tool-making sites. Other artifacts associated with the Paleoindian toolkit include choppers, cutting tools, retouched flakes, and perforators. Sites from this period are very sparse across the landscape and most are deeply buried.

- Archaic Period (ca. 9,000-1,500 B.P.): Archaic sites are characterized by abundant lithic scatters of considerable size with many biface thinning flakes, bifacial preforms broken during manufacture, and well-made groundstone bowls and basin metates. As a consequence of making dart points, many biface thinning waste flakes were generated at individual production stations, which is a diagnostic feature of Archaic sites.
- Late Prehistoric Period (ca. 1,500 B.P.-contact): Sites from this period typically contain small lithic scatters from the manufacture of small arrow points, expedient groundstone tools such as tabular metates and unshaped manos, wooden mortars with stone pestles, acorn or mesquite bean granaries, ceramic vessels, shell beads suggestive of extensive trading networks, and steatite implements such as pipes and arrow shaft straighteners.

### Ethnohistoric Context

The present-day Claremont area lies in the eastern portion of the traditional territory of the Gabrielino, a Takic-speaking people considered to be the most populous and most powerful ethnic group in aboriginal Southern California. The Gabrielino's territory ranged from the San Clemente Island to the San Bernardino-Riverside area and south into southern Orange County. Their influence spread as far as the San Joaquin Valley to the north, the Colorado River to the east, and Baja California to the south.

According to archaeological records, the Gabrielino first arrived in the Los Angeles Basin around 500 B.C., slowly replacing the indigenous Hokan speakers. In response to the varying natural environment of their territory, different groups of the Gabrielino adopted different subsistence economies, albeit all based on some combination of gathering, hunting, and/or fishing. In inland areas, the predominant food sources were acorns, sage, deer, and various small animals, including birds. Because of the similarities to other southern California tribes in economic activities, inland Gabrielino groups' industrial arts, dominated by basket weaving, demonstrated no substantial difference from those of their neighbors. Coastal Gabrielino material culture, on the other hand, reflected an elaborately developed artisanship most recognized through the medium of steatite, which was rivaled by few other groups in southern California.

The intricacies of Gabrielino social organization are not well known, although evidence suggests the existence of a moiety system in which various clans belonged to one or the other of two main social/ cultural divisions. There also seems to have existed at least three hierarchically ordered social classes, topped with an elite consisting of the chiefs, their immediate families, and the very rich. Some individuals owned land, and property boundaries were marked by the owner's personalized symbol. Villages were politically autonomous, composed of nonlocalized lineages, each with its own leader. The dominant lineage's leader was usually the village chief, whose office was generally hereditary through

the male line. Often several villages were allied under the leadership of a single chief. The villages were frequently engaged in warfare against one another, resulting in what some consider to be a state of constant enmity between coastal and inland Gabrielino groups.

As early as 1542, the Gabrielino were in contact with the Spanish during the historic expedition of Juan Rodríguez Cabrillo, but it was not until 1769 that the Spaniards took steps to colonize Gabrielino territory. Shortly afterwards, most of the Gabrielino people were incorporated into Mission San Gabriel and other missions in southern California. Due to introduced diseases, dietary deficiencies, and forceful reduction, Gabrielino population dwindled rapidly. By 1900, they had almost ceased to exist as a culturally identifiable group. In recent decades, however, there has been a renaissance of Native American activism and cultural revitalization among a number of groups of Gabrielino descendants.

### Historic Context

In 1772, three years after the beginning of Spanish colonization of Alta California, Pedro Fages, *comandante* of the new province, and a small force of soldiers under his command became the first Europeans to set foot in the San Bernardino Valley. They were followed in the next few years by two other famed Spanish explorers, Juan Bautista de Anza and Francisco Garcés, who traveled through the valley in the mid-1770s. Despite these early visits, for the next 40 years the inland valley received little impact from the Spanish colonization activities in Alta California, which were concentrated predominantly in the coastal regions.

Following the establishment of Mission San Gabriel in 1771, the San Bernardino Valley became nominally a part of the landholdings of that mission. In the 1830s-1840s, during secularization of the mission system, the Mexican authorities in Alta California made a number of large land grants of former mission properties in the valley. However, the area around the project location was not included in any of these land grants, and remained public land when California became a part of the United States in 1848.

Used primarily for cattle ranching, the San Bernardino Valley saw little development until the mid-19th century, when the U.S. annexation brought waves of American immigrants into the once sparsely populated territory. In 1871, W.T. "Tooch" Martin, the first Euroamerican settler in Claremont, filed a 156-acre claim near present-day Indian Hill Blvd, where he made a living hunting and bee keeping. During the 1880s, the completion of the Santa Fe Railway ended the Southern Pacific Railroad's monopoly on modern transportation in Southern California and brought about a major land boom in the region. Many towns were laid out along the rail lines between San Bernardino and Los Angeles during this time, including Claremont in 1887.

A disastrous drought in the 1890s brought an end to the boom and would have emptied many of the newly created towns were it not for the rise of a highly profitable citrus industry. For Claremont, surviving the lean years of the 1890s was also aided by a decision of the local

land-holding company to donate its showcase hotel in Claremont and 260 vacant lots to the newly established Pomona College in 1888. The college eventually developed into the Claremont Colleges, a consortium of seven institutions. The City of Claremont incorporated in 1907, with 73 of its 131 eligible voters approving the measure. The combination of the thriving citrus industry and the growing college carried the city through the first half of the 20th century until the post-World War II boom.

After the end of World War II, the post-war boom and the completion of Interstate Highway 10 through the area again spurred residential development in Claremont as citrus growers sold their land for housing tracts. Since then, the area's agrarian character has rapidly given way to a suburban landscape. Aside from hosting the Claremont Colleges, today the City of Claremont also serves as one of the many "bedroom communities" along the major commuter routes in the Inland Empire region in support of the Greater Los Angeles area.

The City of Claremont General Plan has identified a number of sites that are on the National Register of Historic Places (NRHP) and other significant historic buildings. In addition, the City has identified a number of neighborhoods that exhibit historic character. The project site is located in the southerly portion of the Northeast Claremont neighborhood, immediately north of the North Claremont neighborhood. The Northeast Claremont neighborhood is characterized by larger lots (one-plus acres) with mature trees along street frontages and between properties, giving the area a rural feel. However, the neighborhood is not designated as an historic district.

## Cultural Resources Assessment

### *Records Search*

An historical/archaeological resources records search was conducted at the South Central Coastal Information Center (SCCIC), California State University, Fullerton. During the records search, maps, records, and electronic databases were examined for previously identified cultural resources and existing cultural resources reports within a one-mile radius of the project area. Previously identified cultural resources include properties designated as California Historical Landmarks, Points of Historical Interest, or San Bernardino County Historical Landmarks, as well as those listed in the National Register of Historic Places, the California Register of Historical Resources, or the California Historical Resources Inventory.

According to records search, the project area had not been covered by any cultural resources surveys prior to that performed for the Miragrand Well project, and no cultural resources had been recorded within the project boundaries. Outside the project area but within a one-mile radius, records show at least 15 previous studies on various tracts of land and linear features. Approximately a quarter of the land within the scope of the records search was covered by these studies, resulting in the identification of five historical/archaeological sites within the one-mile radius including the following sites:

<i>Site Number</i>	<i>Description</i>
19-003747	Prehistoric lithic scatter
19-180639	Claremont Heights Water Company Headquarters Building
19-187085	The Mojave Road
19-188983	The Boulder Dam-Los Angeles 287.5kV Transmission Line
36-015497	San Bernardino Baseline/Baseline Road

One of these sites, 19-003747, was of prehistoric (i.e., Native American) origin. It was recorded more than a half-mile east of the project area and described as a lithic scatter consisting of cores and flakes of obsidian. The other four sites dated to the historic period and included the headquarters buildings of the Claremont Heights Water Company and various linear features of the historical infrastructure. None of these sites was found in the immediate vicinity of the project area, and thus none of them requires further consideration during this study.

#### *Native American Participation*

As part of the Cultural Resources Assessment, a written request was made to the State of California Native American Heritage Commission (NAHC) for a records search in the it's Sacred Lands File. Following the NAHC's recommendations and previously established consultation protocol, a total of ten representatives of local tribes were contacted in writing for additional information on potential Native American cultural resources in the project vicinity.

NAHC responded that the Sacred Lands File identified no Native American cultural resource(s) in the project area but recommended that local Native American groups be contacted for further information and provided a list of potential contacts in the region. The project archaeologist contacted representatives of the tribes including the following:

- Andy Salas, Chairperson, Gabrieleño Band of Mission Indians–Kizh Nation
- Sandonne Goad, Chairperson, Gabrielino/Tongva Nation
- Anthony Morales, Chairperson, Gabrieleno/Tongva San Gabriel Band of Mission Indians
- Robert Dorame, Chairperson, Gabrielino Tongva Indians of California Tribal Council
- Charles Alvarez, Chairperson, Gabrielino Tongva Tribe
- Travis Armstrong, Tribal Historic Preservation Officer, Morongo Band of Mission Indians
- Donna Yocum, Chairperson, San Fernando Band of Mission Indians
- Jessica Mauck, Cultural Resources Analyst, San Manuel Band of Mission Indians
- Mark Cochrane, Co-Chairperson, Serrano Nation of Indians

- Wayne Walker, Co-Chairperson, Serrano Nation of Indians

As of the time of completion of the Cultural Resources Assessment (September 2, 2019), two of the nine tribes have responded in writing. Among them, Jessica Mauck of the San Manuel Band indicated that the project area is located within Serrano ancestral territory and near a former village known as *Toibipet*, but the exact location of the village in relation to the project area is not clear to the tribe. Ms. Mauck states that the information provided in this study may help the tribe during further consultation with TVMWD. Travis Armstrong of the Morongo Band stated that the tribe had no information to provide but may provide other information to the TVMWD future consultation. See Section 3.18, *Tribal Cultural Resources*, for a discussion of TVMWD's AB 52 Consultation efforts.

### *Historical Background Research*

Historical background research for this study was also completed including review of published literature in local and regional history, U.S. General Land Office (GLO) land survey plat maps dated 1865, US Geological Survey (USGS) topographic maps dated 1903-1995, and aerial photographs taken in 1938-2018. The historic maps are collected at the Science Library of the University of California, Riverside, and the California Desert District of the US Bureau of Land Management (BLM), located in Moreno Valley. The aerial photographs are available at the Nationwide Environmental Title Research (NETR) Online website and through the Google Earth software.

Historical sources consulted for this Miragrand Well project Cultural Resources Assessment indicated no man-made features within the project boundaries in the 1850s-1890s era and show the property to be under agricultural use from at least the 1930s to the 1990s. In the 1930s-1950s, the northern portion of Claremont was predominantly occupied by expansive orchards, most likely citrus groves. In the mid-1960s, suburban residential development began to appear on nearby properties, but the grove in the project area survived well into the 1990s, when much of the surrounding area had been suburbanized. The trees of the grove were gradually removed over the next few years, but the land has been left undeveloped to the present time.

### *Field Survey*

A survey of the project site was conducted on foot at an intensive level by walking a series of parallel east-west transects spaced 10 meters (approximately 33 feet) apart wherever such regular transects were practicable. Stockpiles of rock and soil prevented the transects in portions of the project area, and these areas were examined as intensively as visibility allowed. In this way, the ground surface in the entire project area was systematically and carefully examined for any evidence of human activities dating to the prehistoric or historic period (i.e., 50 years or older). Currently TVMWD is using the vacant site for construction staging (equipment parking and material stockpiling) for the Grand Avenue well located approximately ½ mile south of the project site. Except where the stockpiled materials

obscured the surface, ground visibility ranged roughly from 50 percent to 100 percent depending on the density of vegetation growth.

Results of the field survey were negative, and no sites, features, or artifact deposits of prehistoric or historic origin were found. The ground surface in the project area has been extensively disturbed from both past agricultural operations, routine grading for weed abatement, and its recent use as a storage area for construction equipment and materials for the Grand Avenue well site project south of the Miragrand project site.

### *Summary*

The purpose of the Cultural Resources Assessment is to identify any cultural resources within the project area and assist TVMWD in determining whether such resources meet the official definition of “historical resources,” as provided in the California Public Resources Code, in particular CEQA. More specifically, CEQA Guidelines 15064.5 (a)(1)-(3) state that the term “historical resources” applies to any such resources listed in or determined to be eligible for listing in the California Register of Historical Resources (CRHR), included in a local register of historical resources, or determined to be historically significant by the lead agency. Regarding the proper criteria for the evaluation of historical significance, CEQA Guidelines Section 15064.5(a)(3) mandates that “generally a resource shall be considered by the lead agency to be ‘historically significant’ if the resource meets the criteria for listing on the California Register of Historical Resources. A resource may be listed in the California Register if it meets any of the following criteria:

- (1) Is associated with events that have made a significant contribution to the broad patterns of California’s history and cultural heritage.
- (2) Is associated with the lives of persons important in our past.
- (3) Embodies the distinctive characteristics of a type, period, region, or method of construction, or represents the work of an important creative individual, or possesses high artistic values.
- (4) Has yielded, or may be likely to yield, information important in prehistory or history. (Public Resources Code Section 5024.1(c))

In summary of the research results showed that no potential “historical resources” were previously recorded within or adjacent to the project area, and none were identified during the project’s field survey. No notable man-made features were observed on the property throughout the historic period, and Native American input received during the preparation of the Cultural Resources Assessment identified no properties of traditional cultural value at this location. Furthermore, the ground surface in the project area has been extensively disturbed, leaving little vestige of the native landscape. Based on these findings, and in light of the criteria listed above, the Cultural Resources Assessment concluded that no “historical resources” exist within or adjacent to the project area.



CEQA Section 21084.1 establishes that “a project that may cause a substantial adverse change in the significance of a historical resource is a project that may have a significant effect on the environment”. “Substantial adverse change,” according to Public Resources Code Section 5020.1(q), “means demolition, destruction, relocation, or alteration such that the significance of a historical resource would be impaired.”

As stated above, no “historical resources,” as defined by CEQA, were encountered during the preparation of the Cultural Resources Assessment. The project archaeologist has concluded the following:

- No “historical resources” exist within or adjacent to the project area, and thus the project as currently proposed will not cause a substantial adverse change to any known “historical resources.”
- No further cultural resources investigation is necessary for the proposed project unless construction plans undergo such changes as to include areas not covered by this study.
- If buried cultural materials are encountered during any earth-moving operations associated with the project, all work within 50 feet of the discovery should be halted or diverted until a qualified archaeologist can evaluate the nature and significance of the finds.

In addition to the findings of the Cultural Resources Assessment, during consultation with tribes under AB 52, TVMWD received a response from the San Manuel Band of Mission Indians that included suggested mitigation measures. These are provided below in the Mitigation Measures section. New text is double underlined; deleted text is ~~stricken through~~.

5(c) Disturb any human remains, including those interred outside of formal cemeteries?  
**Determination: Less Than Significant Impact with Mitigation Incorporated.**

The surface of the project site has been disturbed over time by past agricultural use as well as routine grading for weed abatement. However, it is unknown whether human remains or known cemeteries are located within the vicinity of the project site, and no conditions exist that suggest human remains are likely to be found on the project site. It is not anticipated that construction activities would disturb human remains, including those interred outside of formal cemeteries. Ground-disturbing activities, such as excavation and trenching, have the potential to disturb human remains. If human remains are found, they will require proper treatment, in accordance with applicable laws. As a result, mitigation measure CUL-3 shall be implemented in order to avoid or lessen potential impacts to human remains from the construction of the proposed Miragrand Well project.

### Mitigation Measures

This section has been updated based on the results of the AB 52 consultation with the Gabrieleño Band of Mission Indians–Kizh Nation which took place subsequent to the

publication of the Draft Initial Study and Notice of Intent to Adopt a Mitigated Negative Declaration. New text is double underlined, and deleted text is stricken through.

The Cultural Resources Assessment prepared for the proposed Miragrand Well project included a recommendation to halt or divert all work within 50 feet of an area where buried cultural resources have been uncovered. However, as part of TVMWD's AB 52 Tribal Consultation, the San Manuel Band of Mission Indians Cultural Resources Analyst recommended more specific measures that have been incorporated into this Initial Study. These were made a part of the Draft Initial Study/MND. Subsequently, the Gabrieleño Band of Mission Indians-Kizh Nation, provided a similar set of measures. The two sets of measures have been combined and are as follows:

### *Cultural Resources*

CUL-1 Prior to commencement of project ground disturbing activities (e.g., clearing and grubbing, tree removal, pot-holing or augering, boring, grading, excavation, drilling and trenching) TVMWD shall retain a qualified archaeological monitor approved by the Gabrieleño Band of Mission Indians-Kizh Nation and is listed under the NAHC's Tribal Contact list for the area of the project location. At the end of monitoring activities, the monitor shall submit a monitoring report that describes construction activities, location, soils, and other pertinent data; and any identified cultural material. Monitoring shall end when the project site grading and excavation activities are completed, or when the monitor concludes that the site has a low potential for impacting Tribal Cultural Resources.

CUL-2 In the event that cultural resources are discovered during project activities, all work in the immediate vicinity of the find (within a 60-foot buffer) shall cease. ~~and a qualified archaeologist meeting Secretary of Interior standards shall be hired to assess the find.~~ Work on the other portions of the project outside of the buffered area may continue during this assessment period. Additionally, the Gabrieleño Band of Mission Indians-Kizh Nation and the San Manuel Band of Mission Indians Cultural Resources Department (SMBMI) shall be contacted, regarding any pre-contact finds and be provided information after the archaeologist makes his/her initial assessment of the nature of the find, so as to provide Tribal input with regards to significance and treatment. (To be implemented in tandem with mitigation measure TCR-1)

CUL-3 If significant pre-contact cultural resources, as defined by CEQA (as amended, 2015), are discovered and avoidance cannot be ensured, the archaeologist shall develop a Monitoring and Treatment Plan, the drafts of which shall be provided to the Gabrieleño Band of Mission Indians-Kizh Nation and SMBMI for review and comment, as detailed within TCR-1. The archaeologist shall monitor the remainder of the project and implement the Plan accordingly.

CUL-4 If human remains or funerary objects are encountered during any activities associated with the project, work in the immediate vicinity (within a 100-foot buffer of the find) shall cease and the County Coroner shall be contacted pursuant to State Health and Safety Code Section 7050.5 and that code enforced for the duration of the project. If the coroner recognizes the human remains to be those of a Native American or has reason to believe that they are those of a Native American, he or she shall contact, by telephone within 24 hours, the Native American Heritage Commission (NAHC) and PRC 5097.98 shall be followed.

### *Tribal Cultural Resources*

Because the analyses of Cultural Resources and Tribal Cultural Resources are interconnected, mitigation measures specific to the issue of Tribal Cultural Resources are included here.

TCR-1 The Gabrieleño Band of Mission Indians-Kizh Nation and San Manuel Band of Mission Indians Cultural Resources Department (SMBMI) shall be contacted, as detailed in CUL-1, of any pre-contact cultural resources discovered during project implementation, and be provided information regarding the nature of the find, so as to provide Tribal input with regards to significance and treatment. Should the find be deemed significant, as defined by CEQA, a Cultural Resources Monitoring and Treatment Plan (CRMTP) shall be created by the archaeologist, in coordination with SMBMI representatives of each tribe, and all subsequent finds shall be subject to this CRMTP. ~~The CRMTP shall allow for a monitor to be present that represents SMBMI for the remainder of the project should SMBMI elect to place a monitor on site include a continuation of the monitoring activities as outlined in mitigation measure CUL-1. allow for a monitor to be present that represents SMBMI for the remainder of the project, should SMBMI elect to place a monitor on-site.~~

TCR-2 Any and all archaeological/cultural documents created as a part of the project (isolate records, site records, survey reports, testing reports, etc.) shall be supplied to ~~the applicant and Lead Agency TVMWD~~ for dissemination to the Gabrieleño Band of Mission Indians-Kizh Nation and SMBMI. The Lead Agency and/or applicant shall, in good faith, consult with SMBMI each of the tribal representatives throughout the life of the project.

### **Impact Conclusions**

Implementation of mitigation measures CUL-1 through CUL-~~34~~, and TCR-1 and TCR-2 would ensure that potential impacts associated with the discovery of unknown cultural resources would be less than significant.

	Potentially Significant Impact	Less Than Significant with Mitigation Incorporated	Less Than Significant Impact	No Impact
<b>3.6 Energy:</b> Would the project:				
a) Result in potentially significant environmental impact due to wasteful, inefficient, or unnecessary consumption of energy resources, during project construction or operation?			✓	
b) Conflict with or obstruct a state or local plan for renewable energy or energy efficiency?			✓	

### Discussion

6(a) Result in potentially significant environmental impact due to wasteful, inefficient, or unnecessary consumption of energy resources, during project construction or operation? **Determination: Less Than Significant Impact.**

California is one of the lowest per capita energy users in the United States, ranked 48th in the nation, due to its energy efficiency programs and mild climate (United States Energy Information Administration [EIA] 2018). California consumed 292,039 gigawatt-hours (GWh) of electricity and 2,110,829 million cubic feet of natural gas in 2017 (California Energy Commission [CEC] 2019; EIA 2018). In addition, Californians consume approximately 18.9 billion gallons of motor vehicle fuels per year (Federal Highway Administration 2019). The single largest end-use sector for energy consumption in California is transportation (39.8 percent), followed by industry (23.7 percent), commercial (18.9 percent), and residential (17.7 percent) (EIA 2018).

Most of California's electricity is generated in-state with approximately 30 percent imported from the Northwest and Southwest in 2017. In addition, approximately 30 percent of California's electricity supply comes from renewable energy sources such as wind, solar photovoltaic, geothermal, and biomass (CEC 2018). Adopted on September 10, 2018, SB 100 accelerates the State's Renewables Portfolio Standards Program by requiring electricity providers to increase procurement from eligible renewable energy resources to 33 percent of total retail sales by 2020, 60 percent by 2030, and 100 percent by 2045.

To reduce statewide vehicle emissions, California requires that all motorists use California Reformulated Gasoline, which is sourced almost exclusively from in-state refineries.

Gasoline is the most used transportation fuel in California with 15.5 billion gallons sold in 2017 and is used by light-duty cars, pickup trucks, and sport utility vehicles (California Department of Tax and Fee Administration 2018). Diesel is the second most used fuel in California with 4.2 billion gallons sold in 2015 and is used primarily by heavy duty-trucks, delivery vehicles, buses, trains, ships, boats and barges, farm equipment, and heavy-duty construction and military vehicles (CEC 2016). Both gasoline and diesel are primarily petroleum-based, and their consumption releases greenhouse gas (GHG) emissions, including CO<sub>2</sub> and NO<sub>x</sub>. The transportation sector is the single largest source of GHG emissions in California, accounting for 41 percent of all inventoried emissions in 2016 (CARB 2018).

### Building Energy Efficiency Standards

The CEC adopted Title 24, Part 6, of the California Code of Regulations; Energy Conservation Standards for new residential and nonresidential buildings in June 1977 and standards are updated every three years. Title 24 ensures building designs conserve energy by requiring the use of new energy efficiency technologies and methods into new developments. Currently, the CEC Title 24 2016 Building Energy Efficiency Standards are in effect; however, the updated 2019 Building Energy Efficiency Standards will take effect on January 1, 2020. The 2019 Building Energy Efficiency Standards states that nonresidential buildings will use about 30 percent less energy compared to the 2016 standards due mainly to lighting upgrades.

### Senate Bill 350

Senate Bill (SB) 350 was signed into law in October 2015 and established new clean energy, clean air, and greenhouse gas reduction goals for 2030. SB 350 established periodic increases to the California Renewables Portfolio Standard (RPS) Program with the target to increase the amount of electricity generated per year from eligible renewable energy resources to an amount that equals at least 33 percent of the total electricity sold annually to retail customers, by December 31, 2020. SB 350 specifically calls for the quantities of eligible renewable energy resources to be procured for all other compliance periods reflecting reasonable progress in each of the intervening years to ensure that the procurement of electricity products from eligible renewable energy resources achieves 40 percent by December 31, 2024, 45 percent by December 31, 2027, and 50 percent by December 31, 2030.

### Senate Bill 100

Senate Bill 100 (SB 100) was signed into law September 2018 and increased the goal of the California RPS Program to achieve at least 50 percent renewable resources by 2026, 60 percent renewable resources by 2030, and 100 percent renewable resources by 2045. SB 100 also includes a State policy that eligible renewable energy resources and zero-carbon resources supply 100 percent of all retail sales of electricity to California end-use customers and 100 percent of electricity procured to serve all State agencies by December 31, 2045.

Under the bill, the State cannot increase carbon emissions elsewhere in the western grid or allow resource shuffling to achieve the 100 percent carbon-free electricity target.

### Project Construction

Energy use during project construction would be primarily in the form of fuel consumption to operate heavy equipment, light-duty vehicles, machinery, and generators. Temporary grid power may also be provided to construction trailers or electrical construction equipment. The anticipated energy consumption from construction equipment and vehicles, including construction worker trips to and from the project site is approximately 1,200 gallons of gasoline fuel and approximately 30,100 gallons of diesel fuel (Refer to Appendix A for Energy calculations).

Energy use during construction would be temporary in nature, and construction equipment used would be typical of similar-sized construction projects in the region. In the interest of cost efficiency, construction contractors are not anticipated to utilize fuel in a manner that is wasteful or unnecessary. Therefore, project construction would not result in a potential impact due to wasteful, inefficient, or unnecessary consumption of energy resources, and no construction-related energy impact would occur.

The pipeline itself would not generate new demand for electricity. The well pump would be served by existing Southern California Edison (SCE) infrastructure. During operation, the proposed project would require approximately 602,250 kWh (or 602.25 MWh) of electricity per year to power the pump station. At completion of project design, the pump design and associated fuel usage would be the most efficient technology available at the time.

Maintenance of the proposed project would include remote monitoring via TVMWD's computer system, meter reading, routine inspections and maintenance of facilities, periodic testing, and emergency repairs. Maintenance activities would occur on an as-needed basis (1 trip per week was assumed). The operation of the pump station as well as vehicle trips by maintenance staff would require the consumption of energy resources in the form of electricity and vehicle fuels. However, electricity and fuel consumption would not be wasteful, inefficient, or unnecessary as maintenance activities would only occur as necessary for well pump operation. Therefore, no operational energy impacts would occur.

In recognition of the project's objective which is to construct facilities necessary for TVMWD to meet its customers' current and projected water demands, the required energy use is not anticipated to result in potentially significant environmental impact due to wasteful, inefficient, or unnecessary consumption of energy resources, during project construction or operation.

6(b) Conflict with or obstruct a state or local plan for renewable energy or energy efficiency? **Determination: Less Than Significant Impact.**

SB 100 mandates 100 percent clean electricity for California by 2045. SCE has achieved over 46 percent Carbon-Free energy sources as of the 2018 Suitability Report. As the proposed project would be powered by the existing electricity grid (SCE), the project would eventually be powered by renewable energy mandated by SB 100 (50 percent by 2026 and 100 percent by 2045) and would not conflict with this statewide plan. TVMWD has not adopted specific renewable energy or energy efficiency plans with which the project could comply. Nonetheless, the project would not conflict with or obstruct the State plan for renewable energy; therefore, no impact would occur.

**Mitigation Measures**

No potentially significant impacts to energy have been identified, therefore no mitigation measures are required.

**Impact Conclusions**

Not applicable.

	Potentially Significant Impact	Less Than Significant with Mitigation Incorporated	Less Than Significant Impact	No Impact
<b>3.7 Geology/Soils/Paleontological Resources:</b> Would the project:				
a) Directly or indirectly cause potential substantial adverse effects, including the risk of loss, injury, or death involving:				
i. Rupture of a known earthquake fault, as delineated on the most recent Alquist-Priolo Earthquake Fault Zoning Map issued by the State Geologist for the area or based on other substantial evidence of a known fault? Refer to Division of Mines and Geology Special Publication 42.				✓
ii. Seismic-related ground failure, including liquefaction?			✓	
iii. Landslides?				✓

	Potentially Significant Impact	Less Than Significant with Mitigation Incorporated	Less Than Significant Impact	No Impact
b) Result in substantial soil erosion or the loss of topsoil?		✓		
c) Be located on a geologic unit or soil that is unstable, or that would become unstable as a result of the project, and potentially result in onsite or offsite landslide, lateral spreading, subsidence, liquefaction or collapse?			✓	
d) Be located on expansive soil, as defined in Table 18-1-B of the Uniform Building Code (1994), creating substantial direct or indirect risks to life or property?			✓	
e) Have soils incapable of adequately supporting the use of septic tanks or alternative wastewater disposal systems where sewers are not available for the disposal of wastewater?				✓
f) Directly or indirectly destroy a unique paleontological resource or site or unique geologic feature?			✓	

**Discussion**

7(a) Expose people or structures to potential substantial adverse effects, including the risk of loss, injury, or death involving:

- i. Rupture of a known earthquake fault, as delineated on the most recent Alquist-Priolo Earthquake Fault Zoning Map issued by the State Geologist for the area or based on other substantial evidence of a known fault? Refer to Division of Mines and Geology Special Publication 42. **Determination: No Impact.**

The following information is from the City of Claremont’s 2015 *Natural Hazards Mitigation* and from Wildermuth Environmental Inc, *Strategic Plan for the Six Basins*, 2017.

The project site is located on a large, broad, alluvial plain located south of the San Gabriel Mountains and atop a depressed portion of the Perris Block of the Peninsular Ranges. The surrounding mountains and hills were uplifted by tectonic compression and faulting, and sediments were eroded and washed out of the mountains by streams and deposited in the low-lying depressions on the Perris Block. These sediments are today’s groundwater



reservoirs. The area underlies the northwestern corner of the Chino Plain between the San Gabriel Mountains and the San Jose Hills to the south and southwest. A major fault in this area - the San Jose Fault - is a known barrier to groundwater flow. Faulting and folding within the region have uplifted bedrock or created low permeability zones within the sediments to create groundwater subbasins from which groundwater is produced.

The project site and surrounding area are located in an urbanized area in the City of Claremont. Due to its proximity to major faults and heavily wooded foothills of the San Gabriel Mountains, the region has experienced earthquakes, floods and wildland fires.

The Sierra Madre Fault and Cucamonga faults run along the southern margin of the San Gabriel Mountains and meet under the northern part of the City. These have the potential to create earthquakes with a magnitude of 7.2 for the Sierra Madre fault and 8.9 for the Cucamonga fault. In addition to these faults, several other faults are located within the region that could have an impact on the City including the San Andreas Fault to the north, and the smaller-scale San Jose Fault that traverses the City. The San Andreas Fault is approximately 15 miles northeast of the City and is considered the most seismically active fault in the southern California region.

Earthquakes that could affect the City would most likely originate from the Sierra Madre, Whittier, San Jose or San Andreas Fault Zones. These faults are close enough in proximity or expected to generate strong enough shaking that could affect the City. The level of seismicity in Claremont, both as to maximum credible earthquake intensity and likely earthquake occurrences, is considered to be approximately the same as for the Los Angeles Basin.

Although the project site is located in the seismically active Southern California region, the project site is not located in an Alquist-Priolo Special Studies Zone, and no known active faults are mapped as crossing or projecting toward the project site area. Due to the absence of active faults near the project site, the risk of damage due to fault rupture during an earthquake is limited. In addition, no faults within or near the City of Claremont have been placed within State of California established Alquist-Priolo Earthquake Fault Zones, which are subject to special land use controls and building standards. Therefore, no impact would occur related to location within an active fault zone.

- ii. Seismic-related ground failure, including liquefaction? **Determination: Less Than Significant Impact.**

In the City of Claremont, the groundwater table (used to determine the risk of liquefaction) is mostly over 100 feet below the surface, except in a few areas where clay lenses exist. This results in a lack of groundwater near the surface, leaving much of the City at low risk for liquefaction. There are two areas within Claremont that are identified as Liquefaction zones; Area 1 starts just north of Foothill Boulevard, going down to just south of Harrison Avenue. It lies east of Baughman Drive and west of College Avenue. Area 2 is located in the southern portion of the city between Foothill Boulevard and 6<sup>th</sup> Street in the vicinity of Indian Hill

Boulevard. The project site is located north of the 210 Freeway well north of either of these zones. Therefore, a less than significant impact would occur related to liquefaction.

iii. Landslides? **Determination: No Impact.**

The project site is located in an area of the City that is gently sloping and there are no hills located nearby. Therefore, there is no risk of landslides on or in the vicinity of the project site.

7(b) Result in substantial soil erosion or the loss of topsoil? **Determination: Less Than Significant Impact with Mitigation Incorporated.**

The project site is routinely disked (graded), removing vegetation from the site to reduce the risk of a brush fire in the neighborhood. As part of the construction activities, the area proposed for well side development – the approximately 10,000 square feet in the southerly portion of the approximately one-acre site – would be graded to provide an area needed to develop the well, construct a wall, pave the site, and construct a well pump house. In addition, the remaining  $\frac{3}{4}$  of the site will be improved with landscape /hardscape. These activities could expose site soils to erosion due to wind or water (storms). In addition, trenching for the pipeline and underground utilities would result in the temporary stockpile of soil adjacent to the trenches. TVMWD has estimated that the length of pipeline between the well site and the connection to the Grand Avenue pipeline is approximately 150 feet.

Because the project site is approximately one acre, the contractor will develop and implement a Stormwater pollution Prevention Plan (SWPPP) to control erosion of soil from the site during construction. The SWPPP will include implementation of Best Management Practices (BMPs) to control runoff and erosion, such as the placement of sandbags and straw wattles around the well drilling site and any soil stockpiles; and around that portion of the site being improved with landscape/hardscape. The development and implementation of a SWPPP would ensure impacts resulting from construction would remain less than significant levels. The development of the well site includes paving the site, putting in sidewalks at the front of the site along Miramar Avenue and Grand Avenue, and maintaining landscaping between the site wall and the sidewalk. This would eliminate opportunities for wind or water to erode exposed topsoil post-construction. The intent in improving the remaining portion of the project site is to control growth of ruderal (weeds) vegetation and minimize erosion by installing groundcover. As such, a less than significant impact on soil erosion or loss of topsoil is expected as a result of construction and operation of the proposed project with implementation of the SWPPP (mitigation measure GEO-1).

7(c) Be located on a geologic unit or soil that is unstable, or that would become unstable as a result of the project, and potentially result in onsite or offsite landslide, lateral spreading, subsidence, liquefaction or collapse? **Determination: Less Than Significant Impact.**

See response to 7(a)ii, regarding ground failure, including liquefaction.

- 7(d) Be located on expansive soil, as defined in Table 18-1-B of the Uniform Building Code (1994), creating substantial risks to life or property? **Determination: Less Than Significant Impact.**

According to the City of Claremont General Plan, most of the city is underlain by soils that have a low potential for expansion, and the groundwater is greater than 100 feet deep. The proposed project would be constructed to meet applicable California and Uniform Building Code standards. Therefore, a there is no impact anticipated as a result of construction and operation of the proposed Project.

- 7(e) Have soils incapable of adequately supporting the use of septic tanks or alternative wastewater disposal systems where sewers are not available for the disposal of wastewater? **Determination: No Impact.**

No septic tanks or other wastewater disposal system are proposed. The proposed project will be connected to the new sewer main being extended along Remington Avenue (see discussion in Section 18, *Utilities and Service Systems*).

- 7(f) Directly or indirectly destroy a unique paleontological resource or site or unique geologic feature? **Determination: Less Than Significant with Mitigation Incorporated.**

Paleontological resources consist of fossils and trace fossils, such as imprints or outlines, that are preserved in sedimentary rock layers; including fine-to medium-grained marine, lake, and stream deposits such as limestone, siltstone, sandstone, or shale, and in ancient soils (paleosols). They are less likely to be found in alluvial material of recent (Holocene) geology such as is located at the project site. Excavation and trenching, other than well drilling, may reach depths of five feet or greater. Should paleontological resources be uncovered, all work within a 50-foot radius of the area shall stop and a qualified paleontologist shall be consulted to determine the significance of the find and if necessary, develop a plan to retrieve and curate the resources at an accredited museum. This is set forth in mitigation measure GEO-2.

Well drilling proposed for the Miragrand Well project would occur at depth in sedimentary deposits that may contain paleontological resources. However, the possibility of identification of paleontological resources is not feasible due to the nature of well drilling. If any paleontological resources are encountered during well drilling, a qualified paleontologist shall be contacted to assess the significance of the paleontological resource. Therefore, mitigation measure GEO-2 would also apply to the well drilling component of the project.

**Mitigation Measures**

GEO-1 Prior to commencement of construction, the construction contractor shall prepare a Stormwater Pollution Prevention Plan (SWPPP) for review by TVMWD; and submit a Notice of Intent (NOI) to the State Water Resources Control Board (SWRCB) who will issue a Waste Discharge Identification Number (WDID) for the project. A copy of the SWPP must be available for review at the construction on-site and modified (if necessary) to address on-site issues, such as heavy storm events that y may require additional measures should they arise.

GEO-2 During well drilling, or excavation/trenching associated with other construction activities at the project site or as part of trenching for the new pipeline, should paleontological resources be uncovered, all work within a 50-foot radius shall cease and a qualified paleontologist shall be consulted to determine the significance of the find and if necessary, develop a plan to retrieve and curate the resources at an accredited museum.

**Impact Conclusions**

Less than significant impact with implementation of mitigation measures GEO-1 and GEO-2.

	Potentially Significant Impact	Less Than Significant with Mitigation Incorporated	Less Than Significant Impact	No Impact
<b>3.8 Greenhouse Gas Emissions:</b> Would the project:				
a) Generate greenhouse gas emissions, either directly or indirectly, that may have a significant impact on the environment?			✓	
b) Conflict with an applicable plan, policy or regulation adopted for the purpose of reducing the emissions of greenhouse gases?			✓	

**Discussion**

8(a) Generate greenhouse gas emissions, either directly or indirectly, that may have a significant impact on the environment? Or

- 8(b) Conflict with an applicable plan, policy or regulation adopted for the purpose of reducing the emissions of greenhouse gases? **Determination: Less Than Significant impact.**

Climate change is the observed increase in the average temperature of the earth's atmosphere and oceans along with other substantial changes in climate (such as wind patterns, precipitation, and storms) over an extended period of time. The baseline against which these changes are measured originates in historical records identifying temperature changes that have occurred in the past, such as during previous ice ages. The global climate is continuously changing, as evidenced by repeated episodes of substantial warming and cooling documented in the geologic record. The rate of change has typically been incremental, with warming or cooling trends occurring over the course of thousands of years. The past 10,000 years have been marked by a period of incremental warming, as glaciers have steadily retreated across the globe. However, scientists have observed acceleration in the rate of warming during the past 150 years. Per the United Nations Intergovernmental Panel on Climate Change (IPCC), the understanding of anthropogenic warming and cooling influences on climate has led to a high confidence (95 percent or greater chance) that the global average net effect of human activities has been the dominant cause of warming since the mid-twentieth century.

Gases that absorb and re-emit infrared radiation in the atmosphere are called greenhouse gases (GHGs). The gases widely seen as the principal contributors to human-induced climate change include carbon dioxide (CO<sub>2</sub>), methane (CH<sub>4</sub>), nitrous oxide (N<sub>2</sub>O), fluorinated gases such as hydrofluorocarbons (HFC) and perfluorocarbons (PFC), and sulfur hexafluoride (SF<sub>6</sub>). Water vapor is excluded from the list of GHGs as it is short-lived in the atmosphere and its atmospheric concentrations are largely determined by natural processes, such as oceanic evaporation.

GHGs are emitted by both natural processes and human activities. Of these gases, CO<sub>2</sub> and CH<sub>4</sub> are emitted in the greatest quantities from human activities. Emissions of CO<sub>2</sub> are largely by-products of fossil fuel combustion, whereas CH<sub>4</sub> results from off-gassing associated with agricultural practices and landfills. Man-made GHGs, many of which have greater heat-absorption potential than CO<sub>2</sub>, include fluorinated gases and SF<sub>6</sub>. Different types of GHGs have varying global warming potentials (GWPs). The GWP of a GHG is the potential of a gas or aerosol to trap heat in the atmosphere over a specified timescale (generally, 100 years). As GHGs absorb different amounts of heat, a common reference gas (CO<sub>2</sub>) is used to relate the amount of heat absorbed to the amount of gas emitted, referred to as "carbon dioxide equivalent" (CO<sub>2</sub>e), and is the amount of a GHG emitted multiplied by its GWP. CO<sub>2</sub> has a 100-year GWP of one. By contrast, CH<sub>4</sub> has a GWP of 25, meaning its global warming effect is 25 times greater than CO<sub>2</sub> on a molecule per molecule basis.

Project implementation would generate GHG emissions through the burning of fossil fuels and other emission sources, thus potentially contributing to cumulative impacts related to

climate change. In response to an increase in man-made GHG concentrations over the past 150 years, California implemented Assembly Bill (AB) 32, the “California Global Warming Solutions Act of 2006.” AB 32 codified the statewide goal of reducing emissions to 1990 levels by 2020 (essentially a 15 percent reduction below 2005 emission levels) and adopted regulations to require reporting and verification of statewide GHG emissions.

On September 8, 2016, the governor signed Senate Bill (SB) 32 into law, which requires the State to further reduce GHGs to 40 percent below 1990 levels by 2030. SB 32 extends AB 32, directing CARB to reduce GHGs to 40 percent below 1990 levels by 2030. In response, on December 14, 2017, CARB adopted the 2017 Scoping Plan, which provides a framework for achieving the 2030 target. The 2017 Scoping Plan does not provide project-level thresholds for land use development. Instead, it recommends that local governments adopt policies and locally appropriate quantitative thresholds consistent with a statewide per capita goal of six metric tons (MT) CO<sub>2</sub>e by 2030. As stated in the 2017 Scoping Plan, these goals may be appropriate for plan-level analyses (city, county, subregional, or regional level), but not for specific individual projects as they include all emissions sectors in the state.

The vast majority of individual projects do not generate sufficient GHG emissions to directly influence climate change. However, physical changes caused by a project can contribute incrementally to cumulative effects that are significant, even if individual changes resulting from a project are limited. The issue of climate change typically involves an analysis of whether a project’s contribution towards an impact would be cumulatively considerable. “Cumulatively considerable” means that the incremental effects of an individual project are significant when viewed in connection with the effects of past projects, other current projects, and probable future projects (CEQA Guidelines Section 15064[h][1]).

### Significance Thresholds for GHG

The CEQA Guidelines provide regulatory direction for the analysis and mitigation of GHG emissions appearing in CEQA documents, while giving lead agencies the discretion to set quantitative or qualitative thresholds for the assessment and mitigation of GHGs and climate change impacts.

In guidance provided by SCAQMD’s GHG CEQA Significance Threshold Working Group in September 2010, SCAQMD considered a tiered approach to determine the significance of residential, commercial, and mixed-use projects.

- *Tier 1.* If the project is exempt from further environmental analysis under existing statutory or categorical exemptions, there is a presumption of less than significant impacts with respect to climate change. If not, then the Tier 2 threshold should be considered.
- *Tier 2.* Consists of determining whether or not the project is consistent with a GHG reduction plan that may be part of a local general plan, for example. The concept embodied in this tier is equivalent to the existing concept of consistency in CEQA

Guidelines section 15064(h)(3), 15125(d) or 15152(a). Under this Tier, if the proposed project is consistent with the qualifying local GHG reduction plan, it is not significant for GHG emissions. If there is not an adopted plan, then a Tier 3 approach would be appropriate.

- *Tier 3.* Establishes a screening significance threshold level to determine significance. The Working Group has provided a recommendation of 3,000 MT of CO<sub>2</sub>e per year for residential, commercial, and mixed-use projects. 10,000 MT of CO<sub>2</sub>e per year for Industrial Projects.
- *Tier 4.* Establishes a service population threshold to determine significance. The Working Group has provided a recommendation of 4.8 MT of CO<sub>2</sub>e per year for land use projects.

Under Tier 2, project impacts would be less than significant if a project is consistent with an approved local or regional plan. TVMWD has not adopted a plan for the reduction of GHG emissions; therefore, Tier 2 does not apply, and the GHG analysis of the project cannot be streamlined via CEQA Guidelines Section 15183.5. As TVMWD does not have a “qualified” GHG reduction plan, this analysis relies on SCAQMD’s Tier 3 screening significance threshold of 3,000 MT of CO<sub>2</sub>e per year to evaluate the project’s GHG emissions.

Project emissions were estimated using CalEEMod. Emission estimates are based on the assumptions outlined above in Section 3.3, *Air Quality*. Calculations of CO<sub>2</sub>, CH<sub>4</sub>, and N<sub>2</sub>O emissions are provided to identify the magnitude of potential project effects. The analysis focuses on CO<sub>2</sub>, CH<sub>4</sub>, and N<sub>2</sub>O as these make up 98.9 percent of all GHG emissions by volume and are the GHG emissions that the project would emit in the largest quantities. Calculations are based on the methodologies discussed in the *California Air Pollution Control Officers Association (CAPCOA) CEQA and Climate Change white paper* and included the use of the *California Climate Action Registry 2009 General Reporting Protocol*. CO<sub>2</sub>, CH<sub>4</sub>, and N<sub>2</sub>O emissions were quantified in CalEEMod (see Appendix A for calculations). It was assumed that all operational vehicle trips to the site would be gasoline vehicles and approximately one maintenance trip per week.

#### *Construction Emissions*

Project construction would generate GHG emissions from the operation of heavy equipment, motor vehicles, and worker trips to and from the site. As shown in Table 7, *GHG Construction Emissions – Well and Pump Station (MT Per Year)* and Table 8, *GHG Construction Emissions – Pipeline (MT Per Year)* emissions from project construction would be approximately 225.4 MT of CO<sub>2</sub>e total over the entire construction period, or approximately 7.5 MT of CO<sub>2</sub>e per year when amortized over a 30-year period in accordance with SCAQMD recommendations.

**Table 7 GHG Construction Emissions – Well and Pump Station (MT Per Year)**

Source/Phase <sup>1</sup>	CO <sub>2</sub>	CH <sub>4</sub>	N <sub>2</sub> O
Site Preparation	0.8	0.0	0.0
Grading	1.7	0.0	0.0
Building Construction	96.3	0.0	0.0
Paving	6.7	0.0	0.0
Architectural Coating	0.7	0.0	0.0
<b>Total (CO<sub>2</sub>e)</b>	<b>99.5</b>		
<b>Amortized over 30 years</b>	<b>3.3</b>		
SCAQMD Threshold	3,000		
<b>Significant</b>	<b>No</b>		

Source: CalEEMod 2016.3.2, Annual Emissions

Notes:

1. Additional pieces of construction equipment were added in the model to allow flexibility to the contractor and present a worst case assumption (i.e. Forklifts, Cranes, Industrial Saws, etc.).

**Table 8 GHG Construction Emissions – Pipeline (MT Per Year)**

Source/Phase	CO <sub>2</sub>	CH <sub>4</sub>	N <sub>2</sub> O
Building Construction	122.0	0.0	0.0
Paving	3.2	0.0	0.0
<b>Total (CO<sub>2</sub>e)</b>	<b>125.9</b>		
<b>Amortized over 30 years</b>	<b>4.2</b>		
SCAQMD Threshold	3,000		
<b>Significant</b>	<b>No</b>		

Source: CalEEMod 2016.3.2, Annual Emissions for the Proposed Miragrand Well Project.

Notes:

1. Additional pieces of construction equipment were added in the model to allow flexibility to the contractor and present a worst case assumption (i.e. Forklifts, Cranes, Industrial Saws, etc.).

### Operational Emissions

In addition to project construction emissions, operation of the proposed Miragrand well site would generate GHG emissions from electricity usage and maintenance activities. As discussed above in Section 3.6, *Energy*, the well pump would require approximately 602,250 kWh of electricity per year for operation.

The pipeline itself would not generate new demand for electricity. The well pump would be served by existing SCE infrastructure. In 2017, SCE's energy portfolio, including utility-owned generation and purchased power, yielded a GHG emissions factor of 0.25 MT of CO<sub>2</sub>e



per megawatt-hour (MWh) (SCE 2018). With an annual electricity demand of 602,250 kWh (or 602.25 MWh), operation of the pump station would generate approximately 150.6 MT of CO<sub>2</sub>e emissions per year.

Maintenance activities would occur on an as-needed basis, modeled at one vehicle maintenance trip per week. Table 9, *Greenhouse Gas Operational Emissions (MT Per Year)*, summarizes the combined annual emissions of GHGs, including construction and operation of the well, pump station, and pipeline. Combined construction and operational GHG emissions would be approximately 162 MT of CO<sub>2</sub>e per year (see Appendix A for CalEEMod worksheets).

As discussed, the proposed project would have a significant impact related to GHG emissions if project-related emissions would exceed 3,000 MT of CO<sub>2</sub>e per year. The project's combined construction and operational GHG emissions would be approximately 160 MT of CO<sub>2</sub>e per year; therefore, the proposed project would not exceed the threshold and impacts would be less than significant.

**Table 9 Greenhouse Gas Operational Emissions (MT Per Year)**

Source	CO <sub>2</sub>	CH <sub>4</sub>	N <sub>2</sub> O
Area	0.0	0.0	0.0
Energy	1.1	0.0	0.0
Mobile	0.4	0.0	0.0
Waste	0.0	0.0	0.0
Water	0.0	0.0	0.0
<b>Total</b>	1.5		
Pump	150.6		
Amortized Construction	7.5		
<b>Total (MTCO<sub>2</sub>e)</b>	<b>160</b>		
SCAQMD Threshold	3,000		
<b>Significant</b>	<b>No</b>		

*Source: CalEEMod 2016.3.2, Annual Emissions for the Proposed Miragrand Well Project*

Development of the MiraGrand well site and related pipeline is in direct response to the growth of the local community/communities. Therefore, the project is consistent with the local Sustainability Plan adopted by the City of Clermont in October of 2013 and is consistent with SCAQMD's 2017 Scoping Plan as it would not exceed the established significance threshold. Therefore, the project would not conflict with any applicable plan, policy, or regulation adopted for the purpose of reducing GHG emissions less than significant is anticipated.

**Mitigation Measures**

No potentially significant impacts to Greenhouse Gas emissions have been identified, therefore no mitigation measures are required.

**Impact Conclusions**

No potentially significant impacts to Greenhouse Gas emissions have been identified.

	Potentially Significant Impact	Less Than Significant with Mitigation Incorporated	Less Than Significant Impact	No Impact
<b>3.9 Hazards and Hazardous Materials:</b> Would the project:				
a) Create a significant hazard to the public or the environment through the routine transport, use, or disposal of hazardous materials?			✓	
b) Create a significant hazard to the public or the environment through reasonably foreseeable upset and accident conditions involving the release of hazardous materials into the environment?			✓	
c) Emit hazardous emissions or handle hazardous or acutely hazardous materials, substances, or waste within one-quarter mile of an existing or proposed school?				✓
d) Be located on a site which is included on a list of hazardous materials sites compiled pursuant to Government Code Section 65962.5 and, as a result, would it create a significant hazard to the public or the environment?				✓
e) For a project located within an airport land use plan or, where such a plan has not been adopted, within two miles of a public airport or public use airport, would the project result in a safety hazard or excessive noise for people residing or working in the project area?			✓	
f) Impair implementation of or physically interfere with an adopted emergency response plan or emergency evacuation plan?			✓	
g) Expose people or structures, either directly or indirectly, to a significant risk of loss, injury or death involving wildland fires?				✓

## DISCUSSION

- 9(a) Create a significant hazard to the public or the environment through the routine transport, use, or disposal of hazardous materials? **Determination: Less Than Significant Impact.**

Construction activities associated with development and operation include drilling, trenching, excavation or other ground disturbing activities to develop the well site and related pipeline. Construction activities would require the transport, use, and disposal of hazardous materials including gasoline, diesel fuel, hydraulic fluids, and other similarly related materials; generally in support of heavy equipment (e.g., drilling rig, dozers) operation. In addition, other materials such as paints, adhesives, solvents, and other substances typically used in construction may also be used on-site during construction. Improper use, storage, or transportation of hazardous materials can result in accidental releases or spills, potentially posing health risks to workers, the public, and the environment. This is a standard risk on all construction projects, and there would be no greater risk for improper handling, transportation, or spills associated with the project than would occur on any other similar well construction site. As such, the proposed project must comply with the requirements of the California Code of Regulations Title 22, Division 4.5 regarding the transport, use, generation and disposal of hazardous materials. Any hazardous material to be used on site would be routinely transported, used, and disposed of in accordance with all applicable laws and regulations intended to protect people and the environment.

There are no water treatment activities associated with the proposed project, only the pumping of groundwater and conveyance of that water to the TVMWD Miramar Water Treatment Plant through the Grand Avenue pipeline. Compliance with all applicable laws and regulations would reduce the potential impact associated with the routine transport, use, storage, or disposal of hazardous materials to a less than significant level.

- 9(b) Create a significant hazard to the public or the environment through reasonably foreseeable upset and accident conditions involving the release of hazardous materials into the environment? **Determination: Less Than Significant Impact.**

See response to 9A above.

- 9(c) Emit hazardous emissions or handle hazardous or acutely hazardous materials, substances, or waste within one-quarter mile of an existing or proposed school? **Determination: No Impact.**

The project site is located in a residential neighborhood. However, the Western Christian School site is located approximately ¼ mile southeast of the project site on Padua Avenue. During project construction limited amounts of hazardous materials such as gasoline, diesel fuel, oils, and solvents associated with standard construction vehicles and equipment would be used. All materials would be routinely transported, used, and disposed of in accordance

with any applicable regulations. During long-term operation, the uses of hazardous materials would be limited to routine maintenance, including solvents, cleaning products and oils; and for the landscaped areas, the use of typical gardening products. There is no backup generator proposed for the project, therefore, no diesel fuel would be used or stored on site. Therefore, the proposed project would have less than significant impacts on the existing school site.

9(d) Be located on a site which is included on a list of hazardous materials sites compiled pursuant to Government Code Section 65962.5 and, as a result, would it create a significant hazard to the public or the environment? **Determination: No Impact.**

The Department of Toxic Substances Control (DTSC) EnviroStor website was accessed on August 12, 2019. The project site does not appear on a list of hazardous materials sites pursuant to Government Code Section 65962.5. Therefore, there is no impact.

9(e) For a project located within an airport land use plan or, where such a plan has not been adopted, within two miles of a public airport or public use airport, would the project result in a safety hazard or excessive noise for people residing or working in the project area? **Determination: Less Than Significant Impact.**

The project site is located approximately 4.5 miles northeast of Brackett Field Airport, a Los Angeles County-owned/operated general aviation airport located at 1615 McKinley Avenue, within the City of La Verne. The project site is located approximately 6.75 miles northwest of the Ontario International Airport. Both airports are well outside the two-mile radius of the project site, therefore there are no impacts associated with proximity of the project site to either airport.

The project site is located approximately 1.5 miles northwest of the Cable Airport runway. Cable Airport is a private general aviation airport located at 1749 W. 13<sup>th</sup> Street in the City of Upland. The *Cable Airport Land Use Compatibility Plan (ALUCP)* was prepared in 2014 in conjunction with efforts by the City of Upland to update its general plan. Guidance contained in the plan was incorporated into the general plan to help ensure that future land use development around the airport is compatible with airport activity. The project site is located in Zone E of the airport's Airport Influence Area (AIA). This designation requires further review for this Initial Study as follows: 1) the Cable Airport ALUCP Map 3C, *Future Airspace Protection Surfaces*, shows that the project site is well outside the Critical Airspace Protection Zone. In addition, ALUCP Map 3D, *Allowable Object Heights*, shows that the project site is located in an area where object heights may be in excess of 150. Finally, because the proposed project does not include the presence of residents or employees, only occasional TVMWD staff performing routine maintenance, the proposed use is not limited by the proximity to the airport. Therefore, the proposed project would have a less than significant impact on public health and safety, including a safety hazard or noise hazard.

A Google Earth search of the project vicinity shows that there is no private airstrip located in the vicinity of the project site. Therefore, there is no impact.

9(f) Impair implementation of or physically interfere with an adopted emergency response plan or emergency evacuation plan? **Determination: Less Than Significant Impact with Mitigation Incorporated.**

The proposed project would not impair or physically interfere with an adopted emergency response plan or a local, State or federal agency's emergency evacuation plan. The project site is located on a vacant lot and public right-of-way at or near the northwest corner of Miramar Avenue and Grand Avenue. Temporary lane closures would be required during construction of the temporary storm drain and the new 8-inch pipeline to connect the well site to the 12-inch Grand Avenue pipeline. These activities would be coordinated with the City's Public Works, Police and Fire Departments to ensure that the intersection of Miramar Avenue and Grand Avenue would be accessible to emergency response vehicles, including ingress and egress to the surrounding properties. As applicable, any traffic detour plans during construction would address emergency response or emergency evacuation for implementation during construction. This is discussed further in Section 3.17, *Transportation*, and in the *Project Description* where it outlined how the construction contractor will prepare and implement a traffic control plan (TCP) during construction. Therefore, this impact would be less than significant and no mitigation is required.

9(g) Expose people or structures, either directly or indirectly, to a significant risk of loss, injury or death involving wildland fires? **Determination: No Impact.**

Wildland fires generally occur in areas of natural vegetation such as forests or foothills covered in brush and scrub type vegetation such as is found along the front of the San Gabriel Mountains. Major factors that contribute to wildland fire behavior are slope and topography, vegetation acting as fuel, and weather. The project site is located in an area of the City that is relatively flat and surrounded by single family residences. The site is routinely disked to control vegetation on site and was recently disked (mid-2019). Therefore, there would be no impact.

### Mitigation Measures

Mitigation measure TR-1 in Section 3.17, *Transportation*, has been identified that requires the construction contractor to prepare and implement a traffic control plan (TCP) during construction.

### Impact Conclusions

Impacts associated with the construction of the new production well, related site improvements and new pipeline on emergency evacuation planning would be less than significant with implementation of the traffic control plan as described in the Project Description. Therefore, no mitigation measure are required.

	Potentially Significant Impact	Less Than Significant with Mitigation Incorporated	Less Than Significant Impact	No Impact
<b>3.10 Hydrology and Water Quality:</b> Would the project:				
a) Violate any water quality standards or waste discharge requirements or otherwise substantially degrade surface or ground water quality?			✓	
b) Substantially decrease groundwater supplies or interfere substantially with groundwater recharge such that the project may impede sustainable groundwater management of the basin?			✓	
c) Substantially alter the existing drainage pattern of the site or area, including through the alteration of the course of a stream or river, or through the addition of impervious surfaces in a manner which would:				
i. result in substantial erosion or siltation onsite or offsite;			✓	
ii. substantially increase the create or amount of surface runoff in a manner which would result in flooding on- or off-site;			✓	
iii. create or contribute runoff water which would exceed the capacity of existing or planned stormwater drainage systems or provide substantial additional sources of polluted runoff; or			✓	
iv. impede or redirect flood flows?			✓	
d) In flood hazard, tsunami, or seiche zones, risk of release of pollutants due to project inundation?				✓
e) Conflict with or obstruct implementation of a water quality control plan or sustainable groundwater management plan?			✓	

## DISCUSSION

10(a) Violate any water quality standards or waste discharge requirements or otherwise substantially degrade surface or ground water quality? **Determination: Less Than Significant Impact.**

**Construction Impacts**

Equipment to be used in the drilling process would consist of a drilling rig, pipe truck, driller's trailer (doghouse), and settling tanks for the discharge water. During drilling and testing of the well, water used in the drilling process will be pumped into two settling tanks. A minimum of two 20,000-gallon discharge water settling tanks would be used for clarification of water prior to discharge; and would be removed upon completion of construction. Although settling times will vary depending on the nature of suspended sediment in the discharge water (e.g. fine-grained sand and silt require more time to settle), previous drilling projects have shown that two tanks are adequate to clarify water such that the suspended sediment in the discharge meets regulatory criteria (in this case, 100 NTU). However, to be proactive, TVMWD may use a third tank. When settlement of soil particles is complete and the water reaches clarity (100 NTU), the water can be released into a storm drain. NTU stands for nephelometric turbidity units. Turbidity is caused by particles in the water that can cause it to be cloudy or opaque. Once the water has reached the requisite NTU rating, it can be released. TVMWD is considering two options for the release of water once it reaches clarity: (1) recharge onsite in an earthen catch basin and/or 2) directing water towards an existing catch basin on Grand Avenue. If directed towards existing catch basin, TVMWD will convey the water into the Baker tanks and then into the newly constructed 8-inch discharge pipeline and fire hydrant.

Handling of the start-up water after completion of well construction (i.e. after drilling and well equipping construction) will be recharged onsite by directing it into an "earthen catch basin" to percolate into the groundwater basin. A portion of the water may be directed towards the existing catch basin on Grand Avenue, via the discharge pipeline, after the confirming the turbidity is less than 100 NTU. Sediment accumulating at the bottom of the tanks may be spread in the on-site area to be maintained in landscape/hardscape; or hauled to an offsite location for disposal.

If the drilling process requires the use of an approved drilling fluid as the circulation medium, liquid (water or drilling fluid) generated from well development and pumping tests would be transferred into trucks and hauled off-site to an approved disposal site. Likewise, the sediment that settles to the bottom of the settling tanks may be spread around that portion of the site to be maintained with landscaping; or removed and transferred to an approved disposal site.

In addition, as part of the construction activities, the area proposed for well side development – the approximately 10,000 square feet in the southerly portion of the approximately one-acre site – would be graded to provide an area needed to develop the well, construct a wall, pave the site, and construct a well pump house. The remaining  $\frac{3}{4}$  of

the site will be improved with landscape /hardscape. These activities could expose site soils to erosion due to wind or water (storms). In addition, trenching for the pipeline and underground utilities would result in the temporary stockpile of soil adjacent to the trenches. TVMWD has estimated that the length of pipeline between the well site and the connection to the Grand Avenue pipeline is approximately 150 feet.

Because the project site is approximately one acre, the contractor will develop and implement a Stormwater pollution Prevention Plan (SWPPP) to control erosion of soil from the site during construction. The SWPPP will include implementation of Best Management Practices (BMPs) to control runoff and erosion, such as the placement of sandbags and straw wattles around the well drilling site and any soil stockpiles; and around that portion of the site being improved with landscape/hardscape. The development and implementation of a SWPPP would ensure impacts resulting from construction would remain less than significant levels. The development of the well site includes paving the site, putting in sidewalks at the front of the site along Miramar Avenue and Grand Avenue, and maintaining landscaping between the site wall and the sidewalk. This would eliminate opportunities for wind or water to erode exposed topsoil post-construction. The intent in improving the remaining portion of the project site is to control growth of ruderal (weeds) vegetation and minimize erosion by installing groundcover. As such, a less than significant impact on soil erosion or loss of topsoil is expected as a result of construction and operation of the proposed project with implementation of the SWPPP (mitigation measure GEO-1).

### Operational Impacts

The City requires that each site also be responsible for controlling its own hydrology and drainage on its site in compliance with the County's MS4 permit for which the City is a co-permittee. All sites must retain stormwater flows on site and treat stormwater in accordance with an approved Water Quality Management Plan (WQMP) that incorporates Low Impact Development (LID) BMPs.

According to the project engineer designing the site, increased storm water runoff associated with the creation of impervious surfaces (parking lot and/or building) will be mitigated by installation of a new catch basin designed to have a storage capacity based on the BMP Design Capture Volume established through the project's Hydrology Study that will be completed as part of project design. The *Preliminary Design Report* for the project states that for well start-up discharge, the site will require a storm drain inlet for disposal of the first flush water from the well. Storm water will also be routed to the storm drain inlet. Therefore, a new on-site storm drain system will be required not only for construction of the proposed Miragrand well but also for project operation.

The new storm drain system will include catch basin inlets, underground piping on site, and a storm drain collection pipe along Grand Avenue. The storm drain design must be reviewed and approved by the City of Claremont. The City as a co-permittee on the County's MS4 permit will require non-structural and structural source control BMP to be incorporated into



project design. Therefore, compliance with these requirements would ensure that impacts associated with on-site drainage would be less than significant.

10(b)(e) Substantially decrease groundwater supplies or interfere substantially with groundwater recharge such that the project may impede sustainable groundwater management of the basin; or conflict with or obstruct implementation of a water quality control plan or sustainable groundwater management plan?

**Determination: Less Than Significant Impact.**

The project site is located in the Six Basins groundwater management area that is under the control of the Six Basins Watermaster, a group of water districts, water companies and municipalities that together manage the groundwater resource for production and distribution to its users. The project site is located in the Upper Claremont Heights Basin. The Six Basins Strategic Plan identified that this basin has good groundwater production associated with the large volumes of recharge, due, in part, to its close proximity to the San Gabriel Mountains. According to the *Strategic Plan for the Six Basins*, there does not appear to be a long-term trend of decline in groundwater levels that would suggest overdraft. These observations suggest that recharge and production have an immediate influence on groundwater levels in the Upper Claremont Heights Basin, and that the groundwater pumpers in this area have the capacity and desire to increase production when groundwater levels are high and reduce production when groundwater levels are lower.

Therefore, as part of the overall strategy for groundwater production and replenishment through natural runoff from the mountains and stormwater, as well as water purchased from the State Water Project, and to a lesser extent, through future recycling efforts that may occur at water reclamation plants, the Miragrand groundwater production well would not substantially decrease groundwater supplies or interfere substantially with groundwater recharge as it is part of a larger concerted effort by all parties to manage groundwater resources. This includes coordination between all Watermaster parties pumping in the Upper Claremont Heights Basin to monitor the water levels in wells during extraction. Should pumping at the Miragrand well site be found to substantially adversely affect the basin water levels, TVMWD will work with the other parties to implement acceptable measures for the well owners and/or purchase replenishment water to be delivered to the San Antonio Spreading Grounds (located approximately 2,000 feet northeast of the project site) or as directed by the Watermaster. This is part of the larger strategy outlined in the *Strategic Plan for the Six Basins* that all parties have agreed to. Therefore, continued cooperation between parties pumping groundwater in the Upper Claremont Heights Basin, would ensure that pumping at the MiraGrand well site would not result in a substantially adverse effect to the basin.

10(c) Substantially alter the existing drainage pattern of the site or area, including through the alteration of the course of a stream or river, or through the addition of impervious surfaces in a manner which would: i) result in substantial erosion or siltation onsite

or offsite; ii) substantially increase the create or amount of surface runoff in a manner which would result in flooding on- or off-site; iii) create or contribute runoff water which would exceed the capacity of existing or planned stormwater drainage systems or provide substantial additional sources of polluted runoff; or iv) impede or redirect flood flows? **Determination: Less Than Significant Impact.**

The project site is located in an established residential neighborhood in the City of Claremont. The entire site is approximately one acre and the area where the well will be developed is approximately 10,000 square feet (less than  $\frac{1}{4}$  acre). The site is undeveloped, s routinely disked for weed abatement, and is currently being used to stage construction equipment and materials for the development of the Grand Avenue groundwater production well project located south of the Miragrand site. Therefore, there is no established drainage pattern on the site as the site under normal conditions is pervious.

Regarding the project resulting in substantial erosion or siltation, see discussion in Section 3.7, *Geology and Soils*, including mitigation measure GEO-1 that requires the construction contractor to prepare an Erosion Control Plan for review and approval by the City of Claremont Public Works Department.

Regarding the project resulting in the creation or contribution of runoff water which would exceed the capacity of existing or planned stormwater drainage systems or provide substantial additional sources of polluted runoff, the project site is a vacant lot located in an established residential neighborhood. The proposed project would result in an increase in impervious surface by approximately 10,000 square feet, the rough equivalent of a new home with related impervious surfaces (driveway, patio, roof, etc.) in the neighborhood. Therefore, the creation of impervious surfaces would be negligible. The remaining approximately  $\frac{3}{4}$  acre will be maintained with landscaping and hard groundcover. This may consist of gravel, mulch or other cover to reduce the prevalence of weeds and control dust from this undeveloped portion of the site. Construction of the proposed project would not alter the course of a stream or river nor would it change the rate or amount of surface runoff that would result in substantial erosion or flooding. Operation of the project would occur at grade or below ground and would not alter the existing grade, drainage pattern of the area, or substantially increase the rate or amount of surface runoff. Therefore, no impact is anticipated as a result of construction and operation of the proposed project.

10(d) In flood hazard, tsunami, or seiche zones, risk of release of pollutants due to project inundation?? **Determination: No Impact.**

The project site is not located near any large inland bodies of water or the Pacific Ocean. Due to the distance from the project site to any major body of water, inundation by seiche or tsunami are unlikely. Further, the project site is located in an area that is relatively flat with no nearby hills or steep slopes where erosion could trigger mudflows. Therefore, no impact would occur. Likewise, the project site is not located near a levee or dam.

**Mitigation Measures**

Regarding water quality standards, mitigation measure GEO-1 in Section 3.7, *Geology and Soils*, requires the development and implementation - during all phases of construction - of a SWPPP for review by TVMWD. In addition, TVMWD is also responsible for maintaining the site -post-construction - to control runoff, in compliance with National Pollutant Discharge Elimination Permit (NPDES) requirements. Therefore, no additional mitigation measures are required.

Regarding the potential to impair implementation of or physically interfere with an adopted emergency response/ evacuation plan, the Project Description includes the preparation of a traffic control plan (TCP) to be implemented during construction. Therefore, no mitigation is required.

**Impact Conclusion**

Implementation of a SWPPP during all phases of construction would ensure that impacts associated with runoff from the project site would be less than significant. Likewise, implementation of a TCP would ensure that emergency vehicles will have continuous access through the project area.

	Potentially Significant Impact	Less Than Significant with Mitigation Incorporated	Less Than Significant Impact	No Impact
<b>3.11 Land Use and Planning:</b> Would the project:				
a) Physically divide an established community?				✓
b) Cause a significant environmental impact due to a conflict with any land use plan, policy, or regulation adopted for the purpose of avoiding or mitigating an environmental effect?			✓	

**Discussion**

11(a) Physically divide an established community? **Determination: No Impact.**

The proposed well will be developed on the southern approximately 10,000 square feet of an approximately one-acre site located at the northwest corner of Miramar Avenue and Grand Avenue in the Northeast Claremont neighborhood, an area characterized by larger lots (one-plus acres) with mature trees along street frontages and between properties, giving the area a rural feel. The remainder of the project site will be maintained with a combination of landscape and hardscape behind the perimeter fencing.

As the project site is located on a corner lot, and the well and pipeline would be located underground, development of the proposed well site and related pipeline would not physically divide an established community. Therefore, there would be no impact.

11(b) Cause a significant environmental impact due to a conflict with any land use plan, policy, or regulation adopted for the purpose of avoiding or mitigating an environmental effect? **Determination: Less Than Significant Impact.**

In addition to the City’ General Plan, other land use plans include the Airport Land Use Plans for the Brackett Field (city of La Verne) and Cable Airport (City of Upland), and the Southern California Association of Government’s (SCAG) Regional Transportation Plan/Sustainable Communities Strategies (RTP/SCS) Plan. In addition, operation of the proposed well must be consistent with the SCAQMD Air Quality Management Plan (AQMP). Consistency with Airport Land Use Plans is evaluated in Section 3.8, *Hazards and Hazardous Materials*, and consistency with the AQMP is evaluated in Section 3.3, *Air Quality*.

**SCAG Regional Transportation Plan/Sustainable Communities Strategies**

SCAG’s 2016 Final RTP/SCS is the applicable SCAG planning document that applies to the proposed project. The RTP/SCS goals are meant to provide guidance for considering a proposed project within the context of regional goals and policies. As shown in Table 10, *Project Consistency with SCAG’s RTP/SCS*, implementation of the project implementation would be consistent with the adopted RTP/SCS. Therefore, impacts would be less than significant.

**Table 10 Project Consistency with SCAG’s RTP/SCS**

Goal	Goal Statement	Project’s Consistency with Goals
G1	Align the plan investments and policies with improving regional economic development and competitiveness.	<i>No inconsistency identified.</i> The policy is implemented by cities and the counties within the SCAG region as part of comprehensive local and regional planning efforts.
G2	Maximize mobility and accessibility for all people and goods in the region.	<i>No inconsistency identified.</i> The proposed project would not generate peak hour trips that
G3	Ensure travel safety and reliability for all people and goods in the region.	<i>No inconsistency identified.</i> The proposed project does not include elements that would result in a substantial safety hazard to motorists. The project area is transitioning from agricultural to light industrial uses and as these projects develop, infrastructure including road improvements will be completed.

**Table 10 Project Consistency with SCAG's RTP/SCS**

Goal	Goal Statement	Project's Consistency with Goals
G4	Preserve and ensure a sustainable regional transportation system.	<i>No inconsistency identified.</i> The policy is implemented by cities and the counties within the SCAG region as part of the overall planning and maintenance of the regional transportation system. The project would have no adverse effect on this planning effort
G5	Maximize the productivity of our transportation system.	<i>No inconsistency identified.</i> The policy would be implemented by cities and the counties within the SCAG region as part of comprehensive transportation planning efforts. The project will be consistent with the City's Transportation Element that meets this goal.
G6	Protect the environment and health for our residents by improving air quality and encouraging active transportation/non-motorized transportation.	<i>No inconsistency identified.</i> See other sections of the Initial Study including Air Quality, Greenhouse Gasses, Hazards/Hazardous Materials, Noise, etc., and discussions of the project's less than significant impact on the environment.
G7	Actively encourage and create incentives for energy efficiency, where possible.	<i>No inconsistency identified.</i> See other sections of the Initial Study including Aesthetics and Air Quality for a discussion of the project's compliance with applicable standard conditions and requirements.
G8	Encourage land use and growth patterns that facilitate transit and non-motorized transportation.	<i>No inconsistency identified.</i> The policy provides guidance to the City to establish a local land use plan that facilitates the use of transit and non-motorized forms of transportation. The Project includes a GPA and SPA to change the land use from Agriculture to Light Industrial. Other sites surrounding the project site are planned for similar land uses. The proposed project is a logical extension of the City's planned growth in The Preserve project area and would facilitate a more efficient transportation system than if the land use remained in Agricultural use with its unimproved roads.
G9	Maximize the security of the regional transportation system through improved system monitoring, rapid recovery planning, and coordination with other security agencies.	<i>No inconsistency identified.</i> The policy provides guidance to the City of Chino to monitor the transportation network and to coordinate with other agencies as appropriate.

Source: SCAG 2016-2040 Regional Transportation Plan/Sustainable Communities Strategy.  
<http://scagrtpscs.net/Pages/FINAL2016RTPSCS.aspx>

Mitigation Measures

No potentially significant impacts were identified. Therefore, no mitigation measures are required.

Impact Conclusions

No impacts to land use or existing communities are associated with the proposed project.

	Potentially Significant Impact	Less Than Significant with Mitigation Incorporated	Less Than Significant Impact	No Impact
<b>3.12 Mineral Resources:</b> Would the project:				
a) Result in the loss of availability of a known mineral resource that would be of value to the region and the residents of the state?			✓	
b) Result in the loss of availability of a locally important mineral resource recovery site delineated on a local general plan, specific plan or other land use plan?			✓	

Discussion

12(a) Result in the loss of availability of a known mineral resource that would be of value to the region and the residents of the state? **Determination: Less Than Significant Impact.**

12(b) Result in the loss of availability of a locally important mineral resource recovery site delineated on a local general plan, specific plan or other land use plan? **Determination: Less Than Significant Impact.**

The City of Claremont General Plan identifies the project area as being within a Mineral Resource Zone 2 (MRZ-2), areas where available geologic information indicates that significant measured or indicated resources are present or where adequate information indicates that significant mineral deposits are present or where it is judged that a high likelihood for their presence exists. This is a State designation that applies to a large area along the front of the San Gabriel Mountains where construction aggregate material, associated with alluvial fans is common.

The project site is located in an established single-family neighborhood surrounded by similar land uses. Therefore, there is no opportunity to recover aggregate resources which were lost when the area was developed with residential neighborhoods. However, there are

areas nearby such as the San Antonio Wash area located east of the project site where this resource has been mined for several decades. It is the City's intent that these areas be protected from incompatible development that would prevent access to the aggregate material should access to these deposits be necessary in the future. Therefore, because the project area is already developed with residential neighborhoods, and there are know aggregate resources being mined nearby in San Antonio Creek wash, the project would have less than significant impact to aggregate resources.

**Mitigation Measures**

There is no impact to mineral resources therefore no mitigation measures have been identified.

**Impact Conclusions**

Not applicable.

	Potentially Significant Impact	Less Than Significant with Mitigation Incorporated	Less Than Significant Impact	No Impact
<b>3.13 Noise:</b> Would the project:				
a) Generation of a substantial temporary or permanent increase in ambient noise levels in the vicinity of the project in excess of standards established in the local general plan or noise ordinance, or applicable standards of other agencies?		✓		
b) Generation of excessive groundborne vibration or groundborne noise levels?		✓		
c) For a project located within the vicinity of a private airstrip or an airport land use plan or, where such a plan has not been adopted, within two miles of a public airport or public use airport, would the project expose people residing or working in the project area to excessive noise levels?			✓	

## Discussion

- 13(a) Generation of a substantial temporary or permanent increase in ambient noise levels in the vicinity of the project in excess of standards established in the local general plan or noise ordinance, or applicable standards of other agencies? **Determination: Less Than Significant Impact with Mitigation Incorporated.**

### *Fundamentals of Noise*

Sound is a disturbance created by a moving or vibrating source that is capable of being detected by the hearing organs. Sound may be thought of as mechanical energy of a moving object transmitted by pressure waves through a medium to a human ear. For traffic or stationary noise, the medium of concern is air. Noise is defined as sound that is loud, unpleasant, unexpected, or unwanted.

A continuous sound is described by its frequency (pitch) and its amplitude (loudness). Frequency relates to the number of pressure oscillations per second. Low-frequency sounds are low in pitch (bass sounding) and high-frequency sounds are high in pitch (squeak). These oscillations per second (cycles) are commonly referred to as Hertz (Hz). The human ear can hear from the bass pitch starting out at 20 Hz all the way to the high pitch of 20,000 Hz. The amplitude of a sound determines its loudness; with loudness increasing or decreasing as the amplitude increases or decreases.

Sound pressure amplitude is measured in units of micro-Newton per square meter (N/m<sup>2</sup>), also called micro-Pascal ( $\mu$ Pa). One  $\mu$ Pa is approximately one hundred billionths (0.0000000001) of normal atmospheric pressure. Sound pressure level is used to describe in logarithmic units the ratio of actual sound pressures to a reference pressure squared. These units are called decibels (dB).

Table 11, *Typical A-Weighted Noise Levels*, shows typical sound levels from common indoor and outdoor noise sources. Because decibels are on a logarithmic scale, sound pressure levels cannot be added or subtracted by a simple plus or minus addition. When two sounds of equal sound pressure level are combined, they will produce a sound pressure level of 3 dB greater than the original single sound pressure level. In other words, sound energy must be doubled to produce a 3 dB increase. If two sounds differ by approximately 10 dB, the higher sound level is the predominant sound.

In general, the healthy human ear is most sensitive to sounds between 1,000 Hz and 5,000 Hz, (A-weighted scale) and it perceives a sound within that range as being more intense than a sound with a higher or lower frequency with the same magnitude. For purposes of this report as well as with most environmental documents, the A-scale weighting is typically reported in terms of A-weighted decibel (dBA). Typically, the human ear can barely perceive a change in noise level of 3 dB. A change in 5 dB is readily perceptible, and a change in 10 dB is perceived as being twice or half as loud.



**Table 11 Typical A-Weighted Noise Levels**

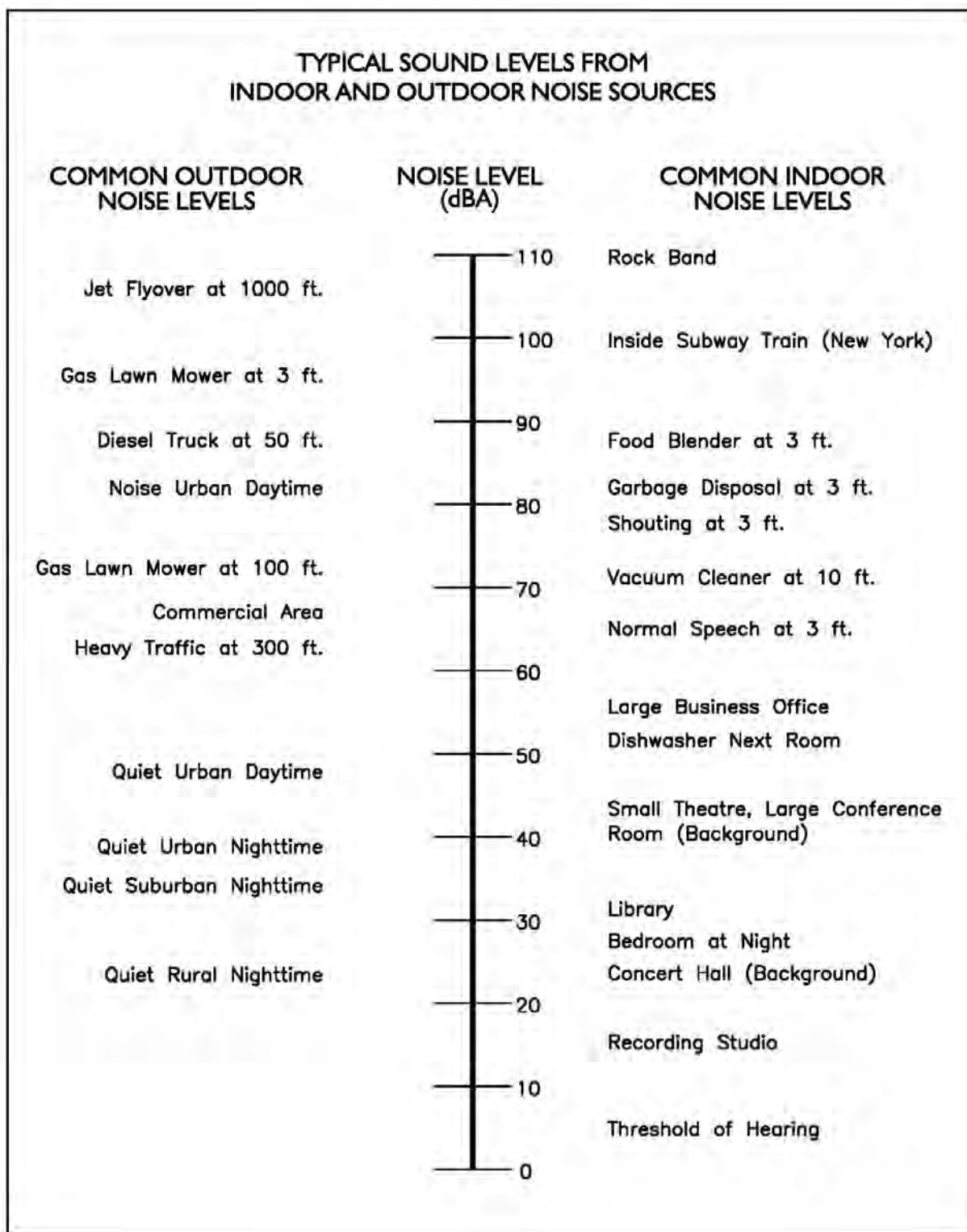

Source: MD Acoustics, Miragrand Groundwater Well Noise Impact Study, August 2019.

As previously discussed, a doubling of sound energy results in a 3 dB increase in sound, which means that a doubling of sound energy (e.g. doubling the volume of traffic on a highway) would result in a barely perceptible change in sound level.

### *Noise Descriptors*

Noise in our daily environment fluctuates over time. Some noise levels occur in regular patterns, others are random. Some noise levels are constant while others are sporadic. Noise descriptors were created to describe the different time-varying noise levels.

*A-Weighted Sound Level:* The sound pressure level in decibels as measured on a sound level meter using the A-weighted filter network. The A-weighting filter de-emphasizes the very low and very high-frequency components of the sound in a manner similar to the response of the human ear. A numerical method of rating human judgment of loudness.

*Ambient or Background Noise Level:* The composite of noise from all sources, near and far. In this context, the ambient noise level constitutes the normal or existing level of environmental noise at a given location.

*Community Noise Equivalent Level (CNEL):* The average equivalent A-weighted sound level during a 24-hour day, obtained after addition of five (5) decibels to sound levels in the evening from 7:00 to 10:00 PM and after addition of ten (10) decibels to sound levels in the night before 7:00 AM and after 10:00 PM.

*dB(A):* A-weighted sound level (see definition below).

*Decibel (dB):* A unit for measuring the amplitude of a sound, equal to 20 times the logarithm to the base 10 of the ratio of the pressure of the sound measured to the reference pressure, which is 20 micro-pascals.

*Equivalent Sound Level (LEQ):* The sound level corresponding to a steady noise level over a given sample period with the same amount of acoustic energy as the actual time-varying noise level. The energy average noise level during the sample period.

*Field Sound Transmission Class (FSTC):* The field sound transmission class (FSTC) rating is used for in situ walls and floor/ceiling sound isolation performance assessment. The standard requires the measurement of sound transmission loss and includes the required procedure to show that the FSTC rating, as it has been determined by the test procedure, was not influenced by flanking of sound around the partition intended to be tested. Sound transmission class and FSTC ratings are intended by standard to be equivalent; however, practical experience indicates that FSTC ratings tend to be up to five ratings points less than laboratory-measured STC ratings.

*L(n):* The A-weighted sound level exceeded during a certain percentage of the sample time. For example, L10 in the sound level exceeded 10 percent of the sample time. Similarly L50, L90, and L99, etc.

*Percent Noise Levels:* See L(n).

*Sound Level (Noise Level):* The weighted sound pressure level obtained by use of a sound level meter having a standard frequency-filter for attenuating part of the sound spectrum.

*Single Event Noise Exposure Level (SENEL):* The dB(A) level which, if it lasted for one second, would the same A-weighted sound energy as the actual event.

### *Traffic Noise Prediction*

Noise levels associated with traffic depends on a variety of factors: (1) volume of traffic, (2) speed of traffic, (3) auto, medium truck (2-3 axle) and heavy truck percentage (4 axle and greater), and sound propagation. The greater the volume of traffic, higher speeds, and truck percentages equate to a louder volume in noise.

### *Sound Propagation*

As sound propagates from a source it spreads geometrically. Sound from a small, localized source (i.e., a point source) radiates uniformly outward as it travels away from the source in a spherical pattern. The sound level attenuates at a rate of 6 dB per doubling of distance. The movement of vehicles down a roadway makes the source of the sound appear to propagate from a line (i.e., line source) rather than a point source. This line source results in the noise propagating from a roadway in a cylindrical spreading versus a spherical spreading that results from a point source. The sound level attenuates for a line source at a rate of 3 dB per doubling of distance.

As noise propagates from the source, it is affected by the ground and atmosphere. Noise models use hard site (reflective surfaces) and soft site (absorptive surfaces) to help calculate predicted noise levels. Hard site conditions (e.g. paved sites) assume no excessive ground absorption between the noise source and the receiver. Soft site conditions such as grass, soft dirt or landscaping attenuate noise at a rate of 1.5 dB per doubling of distance. When added to the geometric spreading, the excess ground attenuation results in an overall noise attenuation of 4.5 dB per doubling of distance for a line source and 7.5 dB per doubling of distance for a point source.

Research has demonstrated that atmospheric conditions can have a significant effect on noise levels when noise receivers are located 200 feet from a noise source. Wind, temperature, air humidity, and turbulence can further impact how far sound can travel.

### *Regulatory Setting*

The proposed project is located in the City of Claremont and noise regulations are addressed through the efforts of various federal, state and local government agencies. The agencies responsible for regulating noise are discussed herein.

### *Federal Regulations*

The adverse impact of noise was officially recognized by the federal government in the Noise Control Act of 1972, which serves three purposes:

- Publicize noise emission standards for interstate commerce
- Assist state and local abatement efforts
- Promote noise education and research

The Federal Office of Noise Abatement and Control (ONAC) originally was tasked with implementing the Noise Control Act. However, it was eventually eliminated leaving other federal agencies and committees to develop noise policies and programs. Some examples of these agencies are as follows:

- The Department of Transportation (DOT) assumed a significant role in noise control through its various agencies.
- The Federal Aviation Agency (FAA) is responsible for regulating noise from aircraft and airports.
- The Federal Highway Administration (FHWA) is responsible for regulating noise from the interstate highway system.
- The Occupational Safety and Health Administration (OSHA) is responsible for the prohibition of excessive noise exposure to workers.

The federal government advocates that local jurisdictions use their land use regulatory authority to arrange new development in such a way that “noise sensitive” uses are either prohibited from being constructed adjacent to a highway or, alternatively that the developments are planned and constructed in such a manner that potential noise impacts are minimized.

Since the federal government has preempted the setting of standards for noise levels that can be emitted by the transportation source, the City is restricted to regulating the noise generated by the transportation system through nuisance abatement ordinances and land use planning.

### *State Regulations*

Established in 1973, the California Department of Health Services Office of Noise Control (ONC) was instrumental in developing regularity tools to control and abate noise for use by local agencies. One significant model is the “Land Use Compatibility for Community Noise Environments Matrix.” The matrix allows the local jurisdiction to clearly delineate compatibility of sensitive uses with various incremental levels of noise.

In addition, the State has established noise insulation standards as outlined in Title 24 and the Uniform Building Code (UBC) which in some cases requires acoustical analyses to outline exterior noise levels and to ensure interior noise levels do not exceed the interior threshold. The State mandates that the legislative body of each county and city adopt a noise element as part of its comprehensive general plan. The local noise element must recognize the land use compatibility guidelines published by the State Department of Health Services. The City of Claremont's compliance with the State regarding noise is discussed below.

### *City of Claremont Noise Regulations*

The City of Claremont outlines their noise regulations and standards within the Public Safety and Noise Element from the General Plan and the Noise Ordinance from the Municipal Code.

### *City of Claremont General Plan*

Applicable policies and standards governing environmental noise in the City are set forth in the General Plan *Public Safety and Noise Element*. The City of Claremont has published their version of these guidelines as illustrated in Table 12, *Land Use Compatibility Guidelines*.

Section 16.154.020 of the Claremont Municipal Code outlines the acceptable noise standards as 60 dBA / 55 dBA, respectively, for residential use. Therefore, because the project site is located in a residential neighborhood, the project must demonstrate compliance to the City's noise standards.

In addition to the noise standards, the City has outlined goals, policies and implementation measures to reduce potential noise impacts and are presented below:

### *Goals, Policies, and Implementation Measures*

Policies and goals from the Public Safety and Noise Element that would mitigate potential impacts on noise include the following:

#### Non-Transportation Noise Sources

*Goal 6-12* Minimize the impact of excessive noise levels throughout the community and adopt appropriate noise level requirements for all land uses.

*Policy 6-12.1* Use noise contour maps and noise/land use compatibility criteria in planning and development decisions.

*Policy 6-12.2* Develop standards and encourage private property owners to locate, screen, and/or buffer equipment in order to reduce noise impacts on surrounding areas.

*Policy 6-12.3* Minimize noise from property maintenance equipment, construction activities and other non- transportation noise sources by enforcing designated construction and maintenance hours.

**Table 12 Land Use Compatibility Guidelines**

Property Receiving Noise		Maximum Noise Level (Ldn or CNEL, dBA)	
Type of Use	Zoning Designation	Interior	Exterior <sup>1</sup>
Residential	Hillside	45	65
	Rural		
	Very Low		
	Low		
	Low Medium	45	65/70 <sup>2</sup>
	High	45	70 <sup>2</sup>
Commercial and Office	Professional/Commercial Neighborhood Limited Major Highway Freeway	--	70
	Professional Office	50	70
Business Park	Business Park	55	75
Public/Institution	Schools	50	65
	All Others	50	70
Open Space	Active Open Space	50	70
	Passive Open Space	50	70/65 <sup>3</sup>

Source: City of Claremont, General Plan Public Safety and Noise Guidelines, Table 6-5, Claremont Land Use/Compatibility Guidelines, 2009.

## Notes:

1. Regarding aircraft-related noise, the maximum acceptable exposure for new residential development is 6 dB CNEL (note: does not apply to this project)
2. Maximum exterior noise levels up to 70 dBA CNEL are allowed for multiple family housing.
3. Where quiet is a basis required for the land use.

*Policy 6-12.4* Require mitigation of any potential noise impacts before allowing mining of aggregate resources.

*City of Claremont – Noise Ordinance*

D. Exterior Noise Standards

1. The Base Noise Level is the ambient noise level or the Ambient Base Noise Level, whichever is higher. The Ambient Base Noise Levels are shown below. Each of the noise limits shall be reduced 5 dBA for noise consisting of impulse or simple tone noise.

Noise Zone	Type of Land Use	Allowed Equivalent Noise Level, Leq	
		7:00 am to 10:00 pm	10:00 pm to 7:00 am
I	Residential - Exterior Noise	60 dBA	55 dBA
II	Commercial - Exterior Noise	65 dBA	60 dBA
III	Industrial - Exterior	70 dBA	70 dBA

1. If the ambient noise exceeds the resulting standard, the ambient noise level shall be the standard.
2. It shall be unlawful for any person at any location within the incorporated area of the City to create any noise or allow the creation of any noise on the property owned, leased, occupied, or otherwise controlled by such person, which causes the noise level when measured on the property line of any other property to exceed the basic noise level as adjusted below:
  - Basic Noise Level for a cumulative period of more than 15 minutes in any one hour; or
  - Basic Noise Level plus 5 dBA for a cumulative period of more than 10 minutes in any one hour; or
  - Basic Noise Level plus 14 dBA for a cumulative period of more than 5 minutes in any one hour; or
  - Basic Noise Level plus 15 dBA at any time.
3. If the measurement location is a boundary between two different noise zones, the lower noise level standard shall apply.
4. If the intruding noise source is continuous and cannot reasonably be discontinued or stopped for a time period whereby the ambient noise level can be determined, the measured noise level obtained while the noise is in operation shall be compared directly to the allowable noise level standards as specified respective to the measurement location's designated land use and for the time of day the noise level is measured. The reasonableness of temporarily discontinuing the noise generation by an intruding noise source shall be determined by the Director or his/her duly authorized deputy for the purpose of establishing the existing ambient noise level at the measurement location.

### *Construction Noise Regulations*

#### F. Exemptions

The following activities shall be exempted from the provisions of this chapter:

4. Noise sources associated with or vibration created by construction, repair, remodeling or grading of any real property, or during authorized seismic surveys, provided:
  - a. Activities take place between the hours of 7:00 AM and 8:00 PM weekdays and Saturdays, excluding national holidays; and

- b. Noise levels, as measured on residential properties, do not exceed 65 dBA for a cumulative period of more than 15 minutes in any one hour, 70 dBA for a cumulative period of more than 10 minutes in any one hour, 79 dBA for a cumulative period of more than 5 minutes in any one hour or 80 dBA at any time; and
- c. Any vibration created does not endanger the public health, welfare, and safety. Only that construction, repair, remodeling and grading activity that does not exceed the noise levels set by Section 16.154.020.D may occur on Sundays and national holidays.

### *Thresholds Applied to the Project*

1. The project's operation must demonstrate compliance to the residential exterior standard of 65 dBA DNL and 60 dBA Leq(h) during the day and 55 dBA, Leq(h) at night.
2. Any construction activity which occurs between the hours of 7PM and 8PM must follow these standards as well. Construction during the day should not exceed 80 dBA at any time.

A twenty-four (24) hour ambient noise measurement was taken at the project site approximately 99 feet from the center of Miramar Avenue and 133 feet from the centerline of Grand Avenue. The measurement measured the 1-hour Leq, Lmin, Lmax and other statistical data (e.g. L2, L8). These represent the average, minimum and maximum A weighted sound levels, as well as measurements of the percentage of time certain sound levels were recorded. The noise measurement was taken to determine the existing baseline noise conditions.

Table 13, *Long Term Noise Measurement Data*, shows the results of the 24-hour noise measurements. The data indicates that ambient noise data at the southwest portion of the project site ranged between 43.0 to 61.8 dBA Leq(h), representing the average noise level spread over an hour. The existing daytime 60 dBA Leq(h) and nighttime 55 dBA Leq(h) conditions are exceeded at various times as indicated in the highlighted areas of Table 13. The exceedances are as a result of existing traffic conditions along the subject roadways.

The measured daily noise level is 58.5 dBA and is within the normally acceptable range when comparing the level to the City's Noise Compatibility Matrix and Municipal Code.

### *Construction Noise Impacts*

The degree of construction noise may vary for different areas of the project site and also vary depending on the construction activities and types of equipment. Noise levels associated with construction will vary with the different phases of construction. The Federal Highway Administration (FHWA) has compiled data regarding the noise generated characteristics of typical construction activities. The data is shown in Table 14, *C/T Equipment Noise Emissions and Acoustical Usage Factor Database*.



**Table 13 Long Term Noise Measurement Data**

Date <sup>1</sup>	Time	dB(A)							
		L <sub>EQ</sub>	L <sub>MAX</sub>	L <sub>MIN</sub>	L <sub>2</sub>	L <sub>8</sub>	L <sub>25</sub>	L <sub>50</sub>	L <sub>90</sub>
7/11/2019	6AM-7AM	55.8	83.2	44.0	63.1	50.9	49.3	48.6	47.7
7/11/2019	7AM-8AM	57.4	72.1	40.3	68.1	59.8	57.1	56.7	53.1
7/11/2019	8AM-9AM	56.6	64.3	55.9	57.3	56.9	56.7	56.7	56.5
7/11/2019	9AM-10AM	52.2	71.4	37.0	60.1	56.5	56.1	48.8	44.2
7/11/2019	10AM-11AM	46.9	65.7	35.4	57.6	50.0	46.8	44.7	40.6
7/11/2019	11AM-12PM	49.3	68.4	35.5	60.7	52.1	48.5	45.8	40.8
7/11/2019	12PM-1PM	53.1	76.0	36.7	64.5	53.6	49.0	46.3	41.7
7/11/2019	1PM-2PM	50.2	70.8	36.6	59.1	52.3	49.6	47.8	44.3
7/11/2019	2PM-3PM	48.2	71.0	36.8	57.2	48.1	45.6	44.2	41.8
7/11/2019	3PM-4PM	62.6	77.5	38.8	70.9	68.4	66.9	63.0	44.5
7/11/2019	4PM-5PM	47.2	65.4	38.5	58.7	49.7	46.3	44.7	42.5
7/11/2019	5PM-6PM	46.8	70.2	39.1	54.8	48.7	46.6	45.4	43.2
7/11/2019	6PM-7PM	45.1	59.7	39.0	52.8	48.2	46.1	44.8	42.8
7/11/2019	7PM-8PM	43.7	56.5	38.3	51.0	46.4	44.4	43.5	41.9
7/11/2019	8PM-9PM	44.6	57.1	39.4	51.4	47.1	45.3	44.5	43.1
7/11/2019	9PM-10PM	45.5	62.4	37.0	53.2	46.6	45.5	44.9	43.5
7/11/2019	10PM-11PM	57.2	85.0	37.6	60.2	44.8	43.4	42.9	41.9
7/11/2019	11PM-12AM	43.0	55.4	39.2	47.0	45.1	44.0	43.3	42.3
7/12/2019	12AM-1AM	48.2	58.9	41.1	53.4	51.1	49.7	48.8	47.3
7/12/2019	1AM-2AM	46.6	54.1	41.3	51.2	49.0	48.1	47.5	45.9
7/12/2019	2AM-3AM	46.9	54.0	42.1	51.9	49.4	47.7	46.9	45.6
7/12/2019	3AM-4AM	49.1	55.9	44.1	50.0	48.6	48.0	47.6	46.6
7/12/2019	4AM-5AM	50.7	69.9	45.6	52.2	51.1	50.4	49.8	48.7
7/12/2019	5AM-6AM	61.8	81.8	47.1	54.6	52.7	51.7	51.1	50.0
<b>Day/Night Level</b>		<b>58.5</b>							

Source: MD Acoustics, Miragrand Groundwater Well Noise Impact Study, Table 2, August 2019.

Notes:

1. Long-term noise monitoring location is shown in Figure X.
2. Saw cutting will not be continuous. In addition, saw cutting will only occur between 7AM to 6PM. Therefore, the noise from cutting is temporary and considered a short-term impact.

**Table 14 C/T Equipment Noise Emissions and Acoustical Usage Factor Database**

Equipment Description	Impact Device?	Acoustical use Factor (%)	Spec. 721.560 Lmax @ 50ft (dBA, slow)	Actual Measured Lmax @ 50ft (dBA, slow)	No. of Actual Data Samples (Count)
All Other Equipment > 5 HP	No	50	85	-N/A-	0
Auger Drill Rig	No	20	85	84	36
Backhoe	No	40	80	78	372
Bar Bender	No	20	80	-N/A-	0
Blasting	Yes	-N/A-	94	-N/A-	0
Boring Jack Power Unit	No	50	80	83	1
Chain Saw	No	20	85	84	46
Clam Shovel (dropping)	Yes	20	93	87	4
Compactor (ground)	No	20	80	83	57
Compressor (air)	No	40	80	78	18
Concrete Batch Plant	No	15	83	-N/A-	0
Concrete Mixer Truck	No	40	85	79	40
Concrete Pump Truck	No	20	82	81	30
Concrete Saw	No	20	90	90	55
Crane	No	16	85	81	405
Dozer	No	40	85	82	55
Drill Rig Truck	No	20	84	79	22
Drum Mixer	No	50	80	80	1
Dump Truck	No	40	84	76	31
Excavator	No	40	85	81	170
Flat Bed Truck	No	40	84	74	4
Front End Loader	No	40	80	79	96
Generator	No	50	82	81	19
Generator (<25KVA, VMS signs)	No	50	70	73	74
Gradall	No	40	85	83	70
Grader	No	40	85	-N/A-	0
Grapple (on backhoe)	No	40	85	87	1
Horizontal Boring Hydr. Jack	No	25	80	82	6
Hydra Break Ram	Yes	10	90	-N/A-	0
Impact Pile Driver	Yes	20	95	101	11
Jackhammer	Yes	20	85	89	133
Man Lift	No	20	85	75	23
Mounted Impact hammer (hoe ram)	Yes	20	90	90	212
Pavement Scarafier	No	20	85	90	2
Paver	No	50	85	77	9
Pickup Truck	No	40	55	75	1

**Table 14 C/T Equipment Noise Emissions and Acoustical Usage Factor Database (continued)**

Equipment Description	Impact Device?	Acoustical use Factor (%)	Spec. 721.560 Lmax @ 50ft (dBA, slow)	Actual Measured Lmax @ 50ft (dBA, slow)	No. of Actual Data Samples (Count)
Pneumatic Tools	No	50	85	85	90
Pumps	No	50	77	81	17
Refrigerator Unit	No	100	82	73	3
Rivit Buster/chipping gun	Yes	20	85	79	19
Rock Drill	No	20	85	81	3
Roller	No	20	85	80	16
Sand Blasting (Single Nozzle)	No	20	85	96	9
Scraper	No	40	85	84	12
Shears (on backhoe)	No	40	85	96	5
Slurry Plant	No	100	78	78	1
Slurry Trenching Machine	No	50	82	80	75
Soil Mix Drill Rig	No	50	80	-N/A-	0
Tractor	No	40	84	-N/A-	0
Vacuum Excavator (Vac-truck)	No	40	85	85	149
Vacuum Street Sweeper	No	10	80	82	19
Ventilation Fan	No	100	85	79	13
Vibrating Hopper	No	50	85	87	1
Vibratory Concrete Mixer	No	20	80	80	1
Vibratory Pile Driver	No	20	95	101	44
Warning Horn	No	5	85	83	12
Welder/Torch	No	40	73	74	5

Source: MD Acoustics, Miragrand Groundwater Well Noise Impact Study, Table 3, August 2019.

Table 15, *Construction Noise Levels - dBA, Leq(h)*, provides the construction noise level projections during the various phases of construction. As shown in Table 15, the noise level during the various phases of construction will vary between 47.1 to 73.8 dBA. The noise level projections include the reduced noise as a result of mufflers and the 24-foot tall noise barrier surrounding the project construction site.

Noise from pavement/concrete cutting will be intermittent and short-term in nature such that while the cutting occurs the noise will reach 73.8 dBA at the nearest sensitive receptor but when cutting does not occur the noise will fall back down to the ambient condition. Cutting of pavement was assumed to occur over a 3 to 5-day period with intermittent saw cutting That would not be continuous.

**Table 15 Construction Noise Levels (dBA, Leq(h))**

Location	Phase	Construction Noise Level <sup>1</sup>	Reduction with Mufflers	Reduction with Wall	Abated Noise Level	Ambient Level <sup>2</sup>	Final Projected Noise Level
Residences	Cutting	88.8	-15.0	N/A	73.8	46.8	73.8
	Laying	87.4	-15.0	N/A	72.4	46.8	72.4
	Paving	88.2	-15.0	N/A	73.2	46.8	73.2
	Drilling	59.0		-14.0	45.0	43.0	47.1
	Building	78.6	-15.0	-14.0	49.6	46.8	51.4

Source: MD Acoustics, Miragrand Groundwater Well Noise Impact Study, Table 4, August 2019.

Notes:

1. Distance projected from center of the well site to the nearest home.
2. Lowest ambient level during operational hours.

This may occur when contractors are putting in the temporary drain between the project site and the existing swale on the east side of Grand Avenue that may be used to convey water used in the well drilling process to the existing storm drain approximately 600 feet south of the project site. Or, when the proposed new 8-inch pipeline between the new well and the 12-inch pipeline in Grand Avenue is constructed.

In addition, saw cutting will only occur between the hours of 7AM to 6PM. Therefore, the noise from cutting would be temporary and considered a short-term impact. Likewise, laying of pipe in the trench along Miramar Avenue will last approximately 2 to 3 days and is short-term in nature. Noise will reach up to 74.4 dBA. The noise from this construction activity is short-term and temporary in nature, and would only occur between 7AM to 6PM and therefore the impact is considered less than significant.

The 24-hour drilling for the new well will last approximately 10 to 14 days. The projected noise level to the nearest sensitive receptor is 47.1 dBA which is below the City's 55 dBA nighttime noise requirement. Noise from drilling will be mitigated using 24-foot tall barriers and mufflers on drilling equipment engines. In addition, contact information will be posted on site to allow local residents to call if nighttime noise is annoying. TVMWD will then consult with the project noise consultant to determine if additional attenuation measures can be taken. Therefore, the impact is less than significant with mitigation.

The repaving of the roadway for either the temporary stormdrain or the permanent pipeline trench is estimated to last approximately 3-days each. The projected noise level to the nearest sensitive receptor is 73.2 dBA. Paving will only occur between 7AM to 6PM and therefore the impact is considered less than significant as the noise will be intermittent and not continuous during paving.

Noise during the construction of the proposed enclosure (building) is projected to be 51.4 dBA and is below the City's noise limit. Construction is anticipated to occur only during the hours of 7AM to 6PM and therefore the impact is considered less than significant.

Construction is anticipated to occur during the permissible hours according the City's Municipal Code except for the 24-hour drilling which should not exceed the nighttime residential noise limit. Construction noise will have a temporary or periodic increase in the ambient noise level above the existing within the project vicinity.

Furthermore, construction design noise reduction measures are provided to further reduce construction noise. These are found in the Mitigation Measures section below.

### *Operational Noise Impacts*

Once construction has been completed it is anticipated that noise associated with the operation of the well would be limited to the well motor. Water passing through the underground pipeline would not generate any audible noise.

The project site is located on the northwest corner of Miragrand Avenue and Grand Avenue within an established residential neighborhood. The main source of operational noise from the well will be the 125-horsepower pump motor that would be enclosed by a concrete masonry unit block building as shown in Figure 9 of Chapter 2, *Project Description*. The room that would house the well and motor will be lined with acoustic panels to further reduce impact to the surrounding residences. To evaluate a worst-case noise scenario for operational noise, the Noise Impact Study was based on noise data for a 400-horsepower well motor.

Based on the referenced data, noise from a 400-horsepower motor is projected to be approximately 90 dBA, Leq at 3 feet from the motor. When projecting the noise level to the nearest sensitive receptor (100 feet from the motor), the noise would measure 59.5 dBA, Leq.

As previously mentioned, the TVMWD is proposing to enclose the motor in a concrete masonry unit block building with a room lined with acoustic panels which will provide at least 30 dB reduction. The noise at the closest sensitive receptor would be approximately 30 dBA, Leq, which is below the City's noise ordinance and will not increase the ambient noise level. Therefore, the project's operations will meet the City's noise limit and will not have a significant impact. Furthermore, the operational noise will not exceed the City's 65 CNEL (day/night level) land use compatibility noise matrix for residential uses.

Mitigation measure NOI-1 requires all contractors to comply with the City's Noise Ordinance regarding construction hours/days as well as erecting a 24-foot high noise barrier around the well during well construction.

During operation, noise associated with pumping would not result in a significant noise impact. Therefore, no mitigation is required.

13(b) Generation of excessive groundborne vibration or groundborne noise levels?

**Determination: Less Than Significant Impact with Mitigation Incorporated.**

### Vibration Descriptors

Ground-borne vibrations consist of rapidly fluctuating motions within the ground that have an average motion of zero. The effects of ground-borne vibrations typically only cause a nuisance to people, but at extreme vibration levels, damage to buildings may occur. Although ground-borne vibration can be felt outdoors, it is typically only an annoyance to people indoors where the associated effects of the shaking of a building can be notable. Ground-borne noise is an effect of ground-borne vibration and only exists indoors since it is produced from noise radiated from the motion of the walls and floors of a room and may also consist of the rattling of windows or dishes on shelves.

Methods used to quantify vibration amplitude are as follows:

*PPV* – Known as the peak particle velocity (PPV) which is the maximum instantaneous peak in vibration velocity, typically given in inches per second.

*RMS* – Known as root mean squared (RMS) can be used to denote vibration amplitude

*VdB* – A commonly used abbreviation to describe the vibration level (VdB) for a vibration source.

### Vibration Perception

Typically, developed areas are continuously affected by vibration velocities of 50 VdB or lower. These continuous vibrations are not noticeable to humans whose threshold of perception is around 65 VdB. Outdoor sources that may produce perceptible vibrations are usually caused by construction equipment, steel-wheeled trains, and traffic on rough roads, while smooth roads rarely produce perceptible ground-borne noise or vibration. To counter the effects of ground-borne vibration, the Federal Transit Administration (FTA) has published guidance relative to vibration impacts. According to the FTA, fragile buildings can be exposed to ground-borne vibration levels of 0.3 inches per second without experiencing structural damage.

### Vibration Propagation

There are three main types of vibration propagation: surface, compression, and shear waves. Surface waves, or Rayleigh waves, travel along the ground's surface. These waves carry most of their energy along an expanding circular wave front, similar to ripples produced by throwing a rock into a pool of water. P-waves, or compression waves, are body waves that carry their energy along an expanding spherical wavefront. The particle motion in these waves is longitudinal (i.e., in a "push-pull" fashion). P-waves are analogous to airborne

sound waves. S-waves, or shear waves, are also body waves that carry energy along an expanding spherical wavefront. However, unlike P-waves, the particle motion is transverse, or side-to-side and perpendicular to the direction of propagation.

As vibration waves propagate from a source, the vibration energy decreases in a logarithmic nature and the vibration levels typically decrease by 6 VdB per doubling of the distance from the vibration source. As stated above, this drop-off rate can vary greatly depending on the soil but has been shown to be effective enough for screening purposes, in order to identify potential vibration impacts that may need to be studied through actual field tests.

## Regulatory Setting

### *City of Claremont*

Section 16.154.020 of the Claremont Municipal Code also addresses vibration as follows:

- J. Notwithstanding other sections of this chapter, it shall be unlawful for any person to create, maintain or cause any ground vibration which is perceptible without instruments at any point on any affected property adjoining the property on which the vibration source is located. For the purpose of this chapter, the perception threshold shall be presumed to be more than 0.05 inches per second RMS vertical velocity.

### Construction Vibration

Construction activities can produce vibration that may be felt by adjacent land uses. The construction of the proposed project would not require the use of equipment such as pile drivers, which are known to generate substantial construction vibration levels. According to the FTA Noise and Vibration Impact Assessment manual, a loaded truck has a PPV of 0.076 in/sec (86 VdB) at 25 feet. At 40 feet from the truck the maximum PPV is 0.045 in/sec and is below any threshold of damage. Appendix D of the Noise Study (see Initial Study Appendix C) provides the vibration calculations. This is within the Claremont Municipal Code guidelines for perception of vibration. Therefore, the impact is considered to be short-term and less than significant. No additional mitigation measures are needed.

- 13(c) For a project located within an the vicinity of a private airstrip or an airport land use plan or, where such a plan has not been adopted, within two miles of a public airport or public use airport, would the project expose people residing or working in the project area to excessive noise levels? **Determination: No Impact.**

The project site is located approximately 1.5 miles northwest of the Cable Airport, a private general aviation airport located at 1749 W. 13<sup>th</sup> Street in the City of Upland. Brackett Field Airport, a Los Angeles County-owned/operated general aviation airport located at 1615 McKinley Avenue, is located approximately 4.5 miles southwest of the project site in the City of La Verne. The proposed project is a new groundwater production well and would not

generate any permanent residents or employees on site that would be exposed to excessive noise levels. Therefore, there is no impact.

## Mitigation Measures

### *Construction*

NOI-1 Construction activities must follow the City's General Plan and the Noise Ordinance, which states that construction, repair or excavation work performed must occur within the permissible hours. To further ensure that construction activities do not disrupt the adjacent land uses, the following measures will be taken:

1. Typical construction will occur between the hours of 7AM and 5PM. Monday through Friday except during holidays.
2. During construction, the contractor will ensure all construction equipment is equipped with appropriate noise attenuating devices.
3. The contractor will locate equipment staging areas that will create the greatest distance between construction-related noise/vibration sources and sensitive receptors nearest the project site during all project construction.
4. Idling equipment will be turned off when not in use.
5. Equipment will be maintained so that vehicles and their loads are secured from rattling and banging.
6. A 24-foot high noise barrier will be placed around the well where noted during well construction (see Noise Study Exhibit G).
7. Nearby residences will be notified before 24-hour drilling and well development activities.
8. Contact information will be posted on site to allow local residents to call. TVMWD may consult with the project noise consultant to determine if additional attenuation measures are needed.

### *Operation*

The Noise Study concluded that constructing the well pump building with masonry block and interior acoustical tiles, noise attenuation of the well pump will ensure that noise levels are below the City's Standards set forth in the Municipal Code. Therefore, no mitigation for operation is required.

### *Impact Conclusions*

As set forth in mitigation measure NOI-1 will ensure that construction noise would remain below the City's Noise Standards. During operation, the use of masonry construction and interior acoustical tile would attenuate noise from the well pump, ensuring that noise generated by the pump motor would be less than significant. Finally, no significant vibration impacts are associated with construction or operation of the proposed project.



	Potentially Significant Impact	Less Than Significant with Mitigation Incorporated	Less Than Significant Impact	No Impact
<b>3.14 Population and Housing:</b> Would the project:				
a) Induce substantial unplanned population growth in an area, either directly (for example, by proposing new homes and businesses) or indirectly (for example, through extension of roads or other infrastructure)?				✓
b) Displace substantial numbers of existing people or housing, necessitating the construction of replacement housing elsewhere?				✓

**Discussion**

14(a) Induce substantial population growth in an area, either directly (for example, by proposing new homes and businesses) or indirectly (for example, through extension of roads or other infrastructure)? **Determination: No Impact.**

14(b) Displace substantial numbers of existing people or housing, necessitating the construction of replacement housing elsewhere? **Determination: No Impact.**

The project site is located in a single-family neighborhood in an area characterized by similar neighborhoods. The purpose of the proposed project is to enhance local water supplies and enhance water supply reliability. There are no new homes or businesses associated with the project that would induce substantial population growth in an area.

The project site is a vacant approximately one-acre site. Therefore, the proposed project would not displace any housing or residents.

**Mitigation Measures**

No significant impacts regarding population and housing are associated with implementation of the proposed project.

**Impact Conclusions**

Not Applicable.

	Potentially Significant Impact	Less Than Significant with Mitigation Incorporated	Less Than Significant Impact	No Impact
<b>3.14 Public Services:</b> Would the project result in substantial adverse physical impacts associated with the provision of new or physically altered governmental facilities, need for new or physically altered governmental facilities, the construction of which could cause significant environmental impacts, in order to maintain acceptable service ratios, response times or other performance objectives for any of the public services:				
a. Fire protection?			✓	
b. Police protection?			✓	
c. Schools?				✓
d. Recreation/Parks?				✓
e. Other public facilities?				✓

### Discussion

15 Would the project result in substantial adverse physical impacts associated with the provision of new or physically altered governmental facilities, need for new or physically altered governmental facilities, the construction of which could cause significant environmental impacts, in order to maintain acceptable service ratios, response times or other performance objectives for any of the public services:

a) Fire protection? **Determination: Less Than Significant Impact.**

Fire protection services are provided to the project area by the Los Angeles County Fire Department. The closest fire station is Station 62 located at 3701 North Mills Avenue at the northwest corner of North Mills Avenue and Pomello Avenue, approximately ½ mile northwest of the project site.

During construction of the proposed well and pipeline, temporary lane closures may be required on Miramar Avenue or Grand Avenue. Construction activities would be carried out in accordance in coordination with the City of Claremont Public Works Departments and Los

Angeles County Fire Department emergency access standards in order to maintain access for local residents. Operation of the well site is passive and it would not require additional fire protection. Less than significant physical impacts would occur to fire protection services as result of construction and operation of the proposed Miragrand well site.

b) Police protection? **Determination: Less Than Significant Impact.**

Police projection services are provided by the Claremont Police Department. The Police Department is located at 570 W Bonita Avenue, Claremont, approximately 2.5 miles southwest of the project site. Most project operations (well pumping and water conveyance through pipeline) would occur underground and would not require additional police protection. In addition, the project would not result in substantial changes to population, housing or traffic that would increase demand on police protection services. Therefore, construction and operation of the Miragrand well site would not result in the need for construction of additional police protection facilities nor would it adversely affect service ratios. During construction interference with the flows of traffic on Grand and/or Miramar avenues may occur. However, construction activities would be carried out in compliance with City of Claremont Public Works Department and Claremont Police Department emergency access standards and access for local residents would be maintained during construction. Less than significant physical impacts would occur to police protection services as result of construction and operation of the proposed MiraGrand well site.

c) Schools? **Determination: No Impact.**

The proposed project does not involve the use, or need for, schools. Construction personnel are anticipated to be from the local area where their school-aged children are already utilizing the existing schools. Therefore, there will be no impact to schools.

d) Recreation/Parks? **Determination: No Impact.**

The construction and operation of the proposed project would not generate additional population that would increase demand for neighborhood or regional parks or other recreational facilities. There are no parks located immediately adjacent to the project site. The nearest park is June Vail Park, located approximately 350 feet south of the project site. No impacts to parks would result from the construction and operation of the proposed Miragrand well site.

e) Other Public Facilities? **Determination: No Impact.**

No other public facilities such as public buildings, recreation centers, parks, public utilities, etc., are located adjacent to the project site. Therefore, construction of the proposed project would not have the potential to temporarily impact access to public facilities. Therefore, there would be no impact to other public facilities

Mitigation Measures

No mitigation measures have been identified.

Impact Conclusions

Not applicable.

	Potentially Significant Impact	Less Than Significant with Mitigation Incorporated	Less Than Significant Impact	No Impact
<b>3.16 Recreation:</b>				
a) Would the project increase the use of existing neighborhood and regional parks or other recreational facilities such that substantial physical deterioration of the facility would occur or be accelerated?				✓
b) Does the project include recreational facilities or require the construction or expansion of recreational facilities which might have an adverse physical effect on the environment?				✓

Discussion

16(a) Would the project increase the use of existing neighborhood and regional parks or other recreational facilities such that substantial physical deterioration of the facility would occur or be accelerated? **Determination: No Impact.**

16(b) Does the project include recreational facilities or require the construction or expansion of recreational facilities which might have an adverse physical effect on the environment?? **Determination: No Impact.**

Neither the construction nor operation of the Miragrand groundwater production well and pipeline would generate additional population that would increase the use of existing neighborhood or regional parks or other recreational facilities. Therefore, no impacts to existing neighborhood and regional parks or other recreational centers are anticipated from construction and operation of the proposed Project.

In addition, the proposed project is a groundwater well and pipeline with appurtenant structures necessary for the operation and maintenance of the well. Construction and operation would not include recreational facilities or require construction or expansion of

recreational facilities, which might have an adverse physical effect on the environment. Therefore, there would be no impact.

**Mitigation Measures**

No mitigation measures have been identified.

**Impact Conclusions**

Not applicable.

	Potentially Significant Impact	Less Than Significant with Mitigation Incorporated	Less Than Significant Impact	No Impact
<b>3.17 Transportation:</b> Would the project:				
a) Conflict with a program, plan, ordinance or policy addressing the circulation system, including transit, roadway, bicycle and pedestrian facilities?				✓
b) Conflict or be inconsistent with CEQA Guidelines section 15064.3, subdivision (b)?		✓		
c) Substantially increase hazards due to a geometric design feature (e.g., sharp curves or dangerous intersections) or incompatible uses (e.g., farm equipment)?				✓
d) Result in inadequate emergency access?			✓	

**Discussion**

17(a) Conflict with a program, plan, ordinance or policy addressing the circulation system, including transit, roadway, bicycle and pedestrian facilities? **Determination: No Impact.**

The proposed project would not conflict with an applicable congestion management program, plan ordinance or policy addressing the circulation system because the project consists of the construction of a new well site and approximately 150 feet of new underground pipeline. Construction staging would occur on site so that most drilling equipment will be brought to the site at the beginning of well drilling construction and removed at the end of drilling. Other material for the pipeline, perimeter wall and fence, landscaping and new sidewalks will be delivered and stored on site or will be delivered at

the actual time of construction of each site element. During operation, vehicle trips would be intermittent and limited to one or two vehicles for maintenance of the well site. Therefore, the project would not conflict with any traffic/circulation program, etc.

17(b) Conflict or be inconsistent with CEQA Guidelines section 15064.3, subdivision (b)?  
**Determination: Less Than Significant Impact with Mitigation Incorporated.**

CEQA Guidelines Section 15064.3(b) sets forth the criteria for analyzing transportation impacts. Specifically, this section of the Guidelines focuses on land use projects and associated vehicle miles traveled. Subsection (b)(4) describes a lead agency's discretion in choosing the most appropriate methodology to evaluate a project's vehicle miles traveled.

The maximum amount of construction laborers and traffic anticipated to work on the site at any point is 10 laborers during the installation of the pipeline, inclusive of equipment operators. The existing vacant lot located at the northwest corner of Miramar Avenue and Grand Avenue will be utilized as the staging yard for the project, limiting the transport of construction equipment to and from the project, once the equipment is brought to the site. All equipment, with the exception of delivery trucks, will be stored on-site in the staging area.

Table 16, *Estimated Peak Hour Project Trips*, gives an estimate of project trips assuming that laborers commute to and from the site, in individual vehicles, during both morning and evening peak hours. These values represent the number of laborers commuting to and from the site (10) as well as 2 delivery trucks entering and exiting the site during the peak hour period. Due to the lack of on-street parking, all construction personnel will need to park within the construction site and staging yard.

**Table 16 Estimated Peak Hour Project Trips**

Morning Peak Hour		Evening Peak Hour	
In	Out	In	Out
12	2	2	12

Source: *Miragrand Well Site Traffic Memo, HKA, August 2019.*

During the construction of the pipeline, work will take place in the travel path at the intersection of Grand Avenue and Miramar Avenue, requiring lane closures to complete these tasks. The construction contractor will be responsible for development of a traffic control plan (TCP) in order to minimize impacts on residents leaving and returning to the neighborhood during construction. The TCP will include consideration of vehicles, bicycles and pedestrians that may need access through the construction zone along Miramar Avenue and Grand Avenue in the vicinity of the project site. The TCP has been identified as an element in the Project Description, therefore, no mitigation is required.

Based on the project description and assumptions above, the amount of construction project trips generated by the site does not create a significant impact on traffic flow in the area or require further analysis.

17(c) Substantially increase hazards due to a geometric design feature (e.g., sharp curves or dangerous intersections) or incompatible uses (e.g., farm equipment)?  
**Determination: No Impact.**

There is no roadway design associated with the proposed MiraGrand well and pipeline project. Therefore, the project would have no impact.

17(d) Result in inadequate emergency access? **Determination: Less Than Significant Impact with Mitigation Incorporated.**

See discussion in 17(b) above regarding the requirement for the construction contractor to prepare and implement a traffic control plan.

Mitigation Measures

Impact Conclusions

Less than significant impact with the implementation of mitigation measure TR-1.

	Potentially Significant Impact	Less Than Significant with Mitigation Incorporated	Less Than Significant Impact	No Impact
<b>3.18 Tribal Cultural Resources:</b> Would the project cause a substantial adverse change in the significance of a tribal cultural resource, defined in Public Resources Code section 21074 as either a site, feature, place, cultural landscape that is geographically defined in terms of the size and scope of the landscape, sacred place, or object with cultural value to a California Native American tribe, and that is:				
a) Listed or eligible for listing in the California Register of Historical Resources, or in a local register of historical resources as defined in Public Resources Code section 5020.1(k), or		✓		

	Potentially Significant Impact	Less Than Significant with Mitigation Incorporated	Less Than Significant Impact	No Impact
b) A resource determined by the lead agency, in its discretion and supported by substantial evidence, to be significant pursuant to criteria set forth in subdivision (c) of Public Resources Code Section 5024.1? In applying the criteria set forth in subdivision (c) of Public Resources Code Section 5024.1, the lead agency shall consider the significance of the resource to a California Native American tribe.		✓		

**Discussion**

18(a) Is the project site listed or eligible for listing in the California Register of Historical Resources, or in a local register of historical resources as defined in Public Resources Code section 5020.1(k). **Determination: Less Than Significant Impact with Mitigation Incorporated.**

The project site is not listed or eligible for listing as an historical resource as defined in Public Resources Code Section 5020.1(k). The code section is specific to a local register of historical resources”, meaning a list of properties officially designated or recognized as historically significant by a local government pursuant to a local ordinance or resolution. A review of the City of Claremont’s General Plan Land Use, Community Character, and Heritage Preservation Element showed that the project site is located in the Northeast Claremont neighborhood but does not appear to be located within a unique neighborhood as identified in the Element. A search of GoogleEarth images shows that the site was a remnant part of a citrus grove that was being replaced by residential land uses. But 1994, the site was vacant with the exception of a few remaining trees. It does not appear that the site ever contained buildings or other improvements that may be considered historic. Therefore, there is no impact to historical resources per PRC Section 5020.1(k). Regarding other CRHR listings, see discussion under 18(b) below.

18(b) A resource determined by the lead agency, in its discretion and supported by substantial evidence, to be significant pursuant to criteria set forth in subdivision (c) of Public Resources Code Section 5024.1? In applying the criteria set forth in subdivision (c) of Public Resources Code Section 5024.1, the lead agency shall consider the significance of the resource to a California Native American tribe. **Determination: Less Than Significant Impact with Mitigation Incorporated.**



*Regulatory Framework*

In addition to the outreach conducted as part of the Cultural Resources Assessment for the project (see Section 3.5, *Cultural Resources*), TVMWD also conducted Tribal Consultation as required under Assembly Bill (AB) 52, when a lead agency prepares a Mitigation Negative Declaration or an Environmental Impact Report (EIR).

This section specifically addresses Tribal Cultural Resources as required under CEQA Section 21074 as follows:

- (a) “Tribal cultural resources” are either of the following:
  - (1) Sites, features, places, cultural landscapes, sacred places, and objects with cultural value to a California Native American tribe that are either of the following:
    - (A) Included or determined to be eligible for inclusion in the California Register of Historical Resources.
    - (B) Included in a local register of historical resources as defined in Public Resources Code Section 5020.1 (k).
  - (2) A resource determined by the lead agency, in its discretion and supported by substantial evidence, to be significant pursuant to criteria set forth in subdivision (c) of Public Resources Code Section 5024.1(c). In applying the criteria set forth in Section 5024.1(c) for the purposes of this paragraph, the lead agency shall consider the significance of the resource to a California Native American tribe.
- (b) A cultural landscape that meets the criteria of subdivision (a) is a tribal cultural resource to the extent that the landscape is geographically defined in terms of the size and scope of the landscape.
- (c) A historical resource described in CEQA Section 21084.1, a unique archaeological resource as defined in CEQA Section 21083.2(g), or a “nonunique archaeological resource” as defined in CEQA Section 21083.2(h) may also be a tribal cultural resource if it conforms with the criteria of subdivision (a).

CEQA Section 21080.3.1(b) requires that prior to the release of a negative declaration, mitigated negative declaration, or environmental impact report for a project, the lead agency shall begin consultation with a California Native American tribe that is traditionally and culturally affiliated with the geographic area of the proposed project if:

- (1) the California Native American tribe requested to the lead agency, in writing, to be informed by the lead agency through formal notification of proposed projects in the geographic area that is traditionally and culturally affiliated with the tribe; and
- (2) the California Native American tribe responds, in writing, within 30 days of receipt of the formal notification, and requests the consultation. When responding to the lead

agency, the California Native American tribe shall designate a lead contact person. If the California Native American tribe does not designate a lead contact person, or designates multiple lead contact people, the lead agency shall defer to the individual listed on the contact list maintained by the Native American Heritage Commission for the purposes of Chapter 905 of the Statutes of 2004. For purposes of this section and Section 21080.3.2, "consultation" shall have the same meaning as provided in Section 65352.4 of the Government Code.

### *AB 52 Consultation*

As part of the Cultural Resources Assessment, the project archaeologist submitted a written request to the State of California NAHC for a records search in the commission's Sacred Lands File. In response NAHC's provided a list of representatives of Native American Tribes that may have additional information on the project area (see Section 3.5 for a discussion of the results of this effort). TVMWD also used the list provided by NAHC to solicit input from Tribal representatives pursuant to the requirements of AB 52.

On August 1, 2019, TVMWD sent a request for consultation, via certified mail, to the tribal representatives using the same list used by the project archaeologist to contact tribal representatives as part of the Cultural Resources Assessment.

At the end of the 30-day period in which a Tribal representative may request consultation, TVMWD received one request for consultation from the Chairperson Andy Salas, of the Gabrieleño Band of Mission Indians-Kizh Nation. Mr. Salas indicated that the project site is within their Ancestral Tribal Territory; therefore, their Tribal Government has requested to schedule a consultation with TVMWD as the lead agency, to discuss the project and the surrounding location in further detail.

In addition, TVMWD received an email from the San Manuel Band of Mission Indians, Cultural Resources Analyst stating that "the proposed project area exists within Serrano ancestral territory and, therefore, is of interest to the Tribe. However, due to the nature and location of the proposed project, and given the CRM Department's present state of knowledge, SMBMI does not have any concerns with the project's implementation, as planned, at this time." The correspondence included a list of mitigation measures to be incorporated into the Cultural Resources and Tribal Cultural Resources sections of the Initial Study, per CEQA Section 21084.3. These measures are included in the Mitigation Measure section below and have been amended to include the Gabrieleño Band of Mission Indians-Kizh Nation request for construction monitoring. New text is double underlined, and deleted text is stricken through.

There were no responses from the remaining representatives, although TVMWD received confirmation that the letter requesting consultation had been received by all but the representative of the Gabrieleno/Tongva San Gabriel Band of Mission Indians, Chairperson

Anthony Morales. Two attempts were made to deliver the letter via certified mail, but they were returned each time. Therefore, TVWMD has complied with AB 52 regarding notification.

The next step in the process is to provide the two representatives with a copy of the Cultural Resources Assessment for their review. This was done via email on September 4, 2019. The representative of the SMBMI responded stating that she had no further comments on the project and would file the report. Consultation is underway with the Gabrieleño Band of Mission Indians–Kizh Nation and will be completed prior to the TVMWD Board taking an action on the project and adopting the Mitigated Negative Declaration. In the interim, the Cultural Resources Assessment did not identify any resources at the project site. The site has been disturbed over the years by past agricultural uses, and the routine disking for weed abatement. The site was being used as a staging area (i.e., equipment parking, material and stockpiles) for the Grand Avenue well construction project located approximately ½ mile south of the project site. Should such unknown resources be uncovered during construction activities at the project site, mitigation measures as set forth below will be implemented.

On October 23, 2019 consultation between TVWMD and the Gabrieleño Band of Mission Indians–Kizh Nation began with a conference call followed Mr. Andy Salas providing additional information regarding the Tribe’s cultural/ancestral connection to the San Gabriel Valley, including within the vicinity of the project site.

The information that San Manuel provided regarding the village of Tobipet as a response to the request for information made by the archaeologist preparing the Cultural Resources Report, is incorrect. It is not their ancestral village but the ancestral to the Gabrieleño, and is not located in Claremont but within the old Rancho San Jose are to the south in the City of Pomona. All mainland villages (sans the Gabrieleño island villages) overlapped each other to help facilitate the movement of tribal cultural resources throughout the landscape and also to sister tribes outside of their traditional ancestral territory. Village use areas were usually shared between village areas and were commonly used by two or more adjoining villages depending on the type, quantity, quality, and availability of natural resources in the area. Therefore, human activity can be pronounced within the shared use areas due to the combined use by multiple villages and Tribal Cultural Resources may be present in the soil layers from the thousands of years of human activity within that landscape.

In addition, Mr. Salas provided maps dated 1898 and 1920, that indicated the hydrography or waterways that existed around the project area prior to urbanization. All water sources were used by the Tribe for life sustenance. Along these watercourses and water bodies occurred permanent villages, seasonal or permanent hamlets, seasonal or permanent trade depots, ceremonial and religious prayer sites, and burials and cremation sites of our ancestors. These activities occurred around water, both inland and coastal, because these water areas created unique habitats and riparian corridors that provided an abundance of food and medicine resources along with aesthetically peaceful areas with running water, shade trees, and shelter.

Larger water bodies were high attractants for human activity and the banks and shores of these water bodies have a higher than average potential for encountering Tribal Cultural Resources of artifacts and human remains during ground disturbing activities. Waterways are a “cultural landscape”, as stated in section 21074. (a) and are protected under AB52 as a tribal cultural resource.

Due to the project site being located within and around a sacred village, and adjacent to sacred water courses and trade routes, there is potential to impact Tribal Cultural Resources still present within the soil from the thousands of years of prehistoric activities that occurred within and around these Tribal Cultural landscapes. Therefore, to avoid impacting or destroying Tribal Cultural Resources that may be inadvertently unearthed during the project's ground disturbing activities, the Tribal Government recommended mitigation measures.

### Mitigation Measures

This section has been updated based on the results of the AB 52 consultation with the Gabrieleño Band of Mission Indians–Kizh Nation which took place subsequent to the publication of the Draft Initial Study and Notice of Intent to Adopt a Mitigated Negative Declaration.

The Cultural Resources Assessment prepared for the proposed Miragrand Well project included a recommendation to halt or divert all work within 50 feet of an area where buried cultural resources have been uncovered. However, as part of TVMWD's AB 52 Tribal Consultation, the San Manuel Band of Mission Indians Cultural Resources Analyst recommended more specific measures that have been incorporated into this Initial Study. These were made a part of the Draft Initial Study/MND. Subsequently, the Gabrieleño Band of Mission Indians–Kizh Nation, provided a similar set of measures. The two sets of measures have been combined and are as follows:

#### *Cultural Resources*

CUL-1 Prior to commencement of project ground disturbing activities (e.g., clearing and grubbing, tree removal, pot-holing or augering, boring, grading, excavation, drilling and trenching) TVMWD shall retain a qualified archaeological monitor approved by the Gabrieleño Band of Mission Indians-Kizh Nation and is listed under the NAHC's Tribal Contact list for the area of the project location. At the end of monitoring activities, the monitor shall submit a monitoring report that describes construction activities, location, soils, and other pertinent data; and any identified cultural material. Monitoring shall end when the project site grading and excavation activities are completed, or when the monitor concludes that the site has a low potential for impacting Tribal Cultural Resources.

CUL-2 In the event that cultural resources are discovered during project activities, all work in the immediate vicinity of the find (within a 60-foot buffer) shall cease. ~~and a~~

~~qualified archaeologist meeting Secretary of Interior standards shall be hired to assess the find.~~ Work on the other portions of the project outside of the buffered area may continue during this assessment period. Additionally, the Gabrieleño Band of Mission Indians-Kizh Nation and the San Manuel Band of Mission Indians Cultural Resources Department (SMBMI) shall be contacted, regarding any pre-contact finds and be provided information after the archaeologist makes his/her initial assessment of the nature of the find, so as to provide Tribal input with regards to significance and treatment. (To be implemented in tandem with mitigation measure TCR-1)

CUL-3 If significant pre-contact cultural resources, as defined by CEQA (as amended, 2015), are discovered and avoidance cannot be ensured, the archaeologist shall develop a Monitoring and Treatment Plan, the drafts of which shall be provided to the Gabrieleño Band of Mission Indians-Kizh Nation and SMBMI for review and comment, as detailed within TCR-1. The archaeologist shall monitor the remainder of the project and implement the Plan accordingly.

CUL-4 If human remains or funerary objects are encountered during any activities associated with the project, work in the immediate vicinity (within a 100-foot buffer of the find) shall cease and the County Coroner shall be contacted pursuant to State Health and Safety Code Section 7050.5 and that code enforced for the duration of the project. If the coroner recognizes the human remains to be those of a Native American or has reason to believe that they are those of a Native American, he or she shall contact, by telephone within 24 hours, the Native American Heritage Commission (NAHC) and PRC 5097.98 shall be followed.

#### *Tribal Cultural Resources*

Because the analyses of Cultural Resources and Tribal Cultural Resources are interconnected, mitigation measures specific to the issue of Tribal Cultural Resources are included here.

TCR-1 The Gabrieleño Band of Mission Indians-Kizh Nation and San Manuel Band of Mission Indians Cultural Resources Department (SMBMI) shall be contacted, as detailed in CUL-1, of any pre-contact cultural resources discovered during project implementation, and be provided information regarding the nature of the find, so as to provide Tribal input with regards to significance and treatment. Should the find be deemed significant, as defined by CEQA, a Cultural Resources Monitoring and Treatment Plan (CRMTP) shall be created by the archaeologist, in coordination with SMBMI representatives of each tribe, and all subsequent finds shall be subject to this CRMTP. ~~The CRMTP shall allow for a monitor to be present that represents SMBMI for the remainder of the project should SMBMI elect to place a monitor on site~~ include a continuation of the monitoring activities as outlined in mitigation

~~measure CUL-1. allow for a monitor to be present that represents SMBMI for the remainder of the project, should SMBMI elect to place a monitor on site.~~

TCR-2 Any and all archaeological/cultural documents created as a part of the project (isolate records, site records, survey reports, testing reports, etc.) shall be supplied to ~~the applicant and Lead Agency TVMWD~~ for dissemination to the Gabrieleño Band of Mission Indians-Kizh Nation and SMBMI. The Lead Agency and/or applicant shall, in good faith, consult with SMBMI each of the tribal representatives throughout the life of the project.

**Impact Conclusions**

Implementation of mitigation measures CUL-1 and CUL-2, and TCR-1 and TCR-2 would ensure that potential impacts associated with the discovery of unknown tribal cultural resources would be less than significant.

	Potentially Significant Impact	Less Than Significant with Mitigation Incorporated	Less Than Significant Impact	No Impact
<b>3.19 Utilities and Service Systems:</b> Would the project:				
a) Require or result in the relocation or construction of new or expanded water, wastewater treatment or stormwater, drainage, electric power, natural gas, or telecommunications facilities, the construction of which could cause significant environmental effects?				✓
b) Have sufficient water supplies available to serve the project and reasonably foreseeable future development during normal, dry and multiple dry years?				✓
c) Result in a determination by the wastewater treatment provider which serves or may serve the project that it has adequate capacity to serve the project's projected demand in addition to the provider's existing commitments?				✓

	Potentially Significant Impact	Less Than Significant with Mitigation Incorporated	Less Than Significant Impact	No Impact
d) Generate solid waste in excess of State or local standards, or in excess of the capacity of local infrastructure, or otherwise impair the attainment of solid waste reduction goals?		✓		
e) Comply with federal, state, and local management and reduction regulations related to solid waste?		✓		

### Discussion

19(a) Require or result in the relocation or construction of new or expanded water, wastewater treatment or stormwater, drainage, electric power, natural gas, or telecommunications facilities, the construction of which could cause significant environmental effects? **Determination: No Impact.**

The proposed project is a groundwater well and associated structures or facilities, including approximately 150 foot 8-inch pipeline to connect the new well to the existing 12-inch pipeline in Grand Avenue; and a perimeter wall around the well site, landscaping, and sidewalks.

During construction, electric power is available from local SCE power lines. Equipment that requires additional power will be from diesel generators. Some equipment may also use gasoline. None of these fuels will be stored on site. Once construction is completed, operation of the facility will utilize electric power from the grid. Energy consumption during long-term operation is evaluated in Section 3.6, *Energy*. Regarding energy, the conclusion is that the project would have a less than significant impact on electric power.

19(b) Have sufficient water supplies available to serve the project and reasonably foreseeable future development during normal, dry and multiple dry years? **Determination: No Impact.**

The proposed project is a new groundwater production to be developed at the northwest corner of Grand Avenue and Miramar Avenue, that will become a part of TVMWDs groundwater production system intended to increase the reliability of the water supply during normal, dry and multiple dry years.

19(c) Result in a determination by the wastewater treatment provider which serves or may serve the project that it has adequate capacity to serve the project's projected demand in addition to the provider's existing commitments? **Determination: No Impact.**

The project does not include any new residences or businesses that would be occupied, therefore, no water or sewer service is proposed for the site. As such, the proposed project would not contribute any new wastewater to the existing system. Therefore, there is no impact.

19(d) Generate solid waste in excess of State or local standards, or in excess of the capacity of local infrastructure, or otherwise impair the attainment of solid waste reduction goals? **Determination: Less Than Significant Impact with Mitigation Incorporated.**

Small volumes of construction-related waste and inert demolition debris (e.g. asphalt) will require disposal during proposed project construction. Construction and Demolition (C&D) material generated during project construction may include but is not limited to asphalt, concrete, cardboard, plastics, and metal. Per the California Green Building Standards Code (CalGreen) all construction projects in the City of Claremont are required to divert a minimum of 65 percent of C&D waste from landfill disposal. Therefore mitigation measure USS-1 has been identified that requires the construction contractor to submit a C&D disposal plan to the City Public Works Department for review and approval.

19(e) Comply with federal, State, and local management and reduction regulations related to solid waste? **Determination: Less Than Significant Impact with Mitigation Incorporated.**

All solid waste generated during construction activities would be handled in accordance with all applicable federal, State, and local statutes and regulations. Therefore, no impacts would occur under this criterion as a result of future project construction activities. Project operation would consist of routine maintenance and emergency repairs. These activities are not expected to generate solid waste; however, any solid waste generated by the project during operations would be handled in accordance with all applicable federal, State, and local statutes and regulations. Therefore, no impacts from operations would occur under this criterion as a result of the project.

### Mitigation Measures

USS-1 Prior to commencement of construction, the contractor shall prepare a Construction and Demolition disposal plan for review and approval by TVMWD. The plan shall include the name and location of the facility(s) that would accept C&D waste from the project site, thus diverting this waste from a landfill.

### Impact Conclusions

With implementation of mitigation measure USS-1, impacts associated with solid waste would be less than significant.



	Potentially Significant Impact	Less Than Significant with Mitigation Incorporated	Less Than Significant Impact	No Impact
<b>3.20 Wildfire:</b> If located in or near state responsibility areas or lands classified as very high fire hazard severity zones, would the project:				
a) Substantially impair an adopted emergency response plan or emergency evacuation plan?			✓	
b) Due to slope, prevailing winds, and other factors, exacerbate wildfire risks, and thereby expose project occupants to, pollutant concentrations from a wildfire or the uncontrolled spread of a wildfire?				✓
c) Require the installation or maintenance of associated infrastructure (such as roads, fuel breaks, emergency water sources, power lines or other utilities) that may exacerbate fire risk or that may result in temporary or ongoing impacts to the environment?				✓
d) Expose people or structures to significant risks, including downslope or downstream flooding or landslides, as a result of runoff, post-fire slope instability, or drainage changes?				✓

**Discussion**

20(a) Substantially impair an adopted emergency response plan or emergency evacuation plan? **Determination: Less Than Significant Impact with Mitigation Incorporated.**

The proposed project would not impair or physically interfere with an adopted emergency response plan or a local, State or federal agency’s emergency evacuation plan. The project site is located on a vacant lot and public right-of-way at or near the northwest corner of Miramar Avenue and Grand Avenue. Temporary lane closures would be required during construction of the new pipeline to connect the well site to the 12-inch Grand Avenue pipeline. This activity would be coordinated with the City’s Public Works and Police Departments, and the Los Angeles County Fire Departments to ensure that the intersection of Miramar Avenue and Grand Avenue would be accessible to emergency response vehicles, including ingress and egress to the surrounding properties.

The construction contractor will be responsible for development of a traffic control plan (TCP) in order to minimize impacts on residents leaving and returning to the neighborhood during construction. The TCP will include consideration of vehicles, bicycles and pedestrians that may need access through the construction zone along Miramar Avenue and Grand Avenue in the vicinity of the project site. The Project Description includes the preparation of a traffic control plan (TCP) to be implemented during construction. Therefore, no mitigation is required.

20(b) Due to slope, prevailing winds, and other factors, exacerbate wildfire risks, and thereby expose project occupants to, pollutant concentrations from a wildfire or the uncontrolled spread of a wildfire? **Determination: No Impact.**

There are no occupants associated with the proposed project. The project does not include any new residents or employees. TVMDW employees will visit the site occasionally to perform routine maintenance. Therefore, there is no impact.

20(c) Require the installation or maintenance of associated infrastructure (such as roads, fuel breaks, emergency water sources, power lines or other utilities) that may exacerbate fire risk or that may result in temporary or ongoing impacts to the environment? **Determination: No Impact.**

The project site is located within an existing residential neighborhood and is readily accessible from Miramar Avenue and Grand Avenue. No new infrastructure is being developed that would exacerbate fire risk or result in temporary or ongoing impacts to the environment.

20(d) Expose people or structures to significant risks, including downslope or downstream flooding or landslides, as a result of runoff, post-fire slope instability, or drainage changes? **Determination: No Impact.**

The project site is located within a single-family neighborhood in an area with geography that is characterized as a gently sloping alluvial fan. There are no hillsides or other slopes in the area that would be affected by fire resulting in post fire slope instability. Nor is there an opportunity for landslides to occur on or in the vicinity of the project site. The project does not include any changes in drainage features. Therefore, there would be no impact.

### Mitigation Measures

Regarding the potential to impair implementation of or physically interfere with an adopted emergency response/ evacuation plan, the Project Description includes the preparation of a traffic control plan (TCP) to be implemented during construction. Therefore, no mitigation is required.

**Impact Conclusions**

With development and implementation of the TCP as described in the Project Description, temporary construction impacts on the flow of local traffic including emergency vehicles, would be less than significant.

	Potentially Significant Impact	Less Than Significant with Mitigation Incorporated	Less Than Significant Impact	No Impact
<b>3.21 Mandatory Findings of Significance:</b>				
a) Does the project have the potential to degrade the quality of the environment, substantially reduce the habitat of a fish or wildlife species, cause a fish or wildlife population to drop below self-sustaining levels, threaten to eliminate a plant or animal community, reduce the number or restrict the range of a rare or endangered plant or animal or eliminate important examples of the major periods of California history or prehistory?		✓		
b) Does the project have impacts that are individually limited, but cumulatively considerable? ("Cumulatively considerable" means that the incremental effects of a project are considerable when viewed in connection with the effects of past projects, the effects of other current projects, and the effects of probable future projects)?		✓		
c) Does the project have environmental effects which will cause substantial adverse effects on human beings, either directly or indirectly?		✓		

**Discussion**

21(a) Does the project have the potential to degrade the quality of the environment, substantially reduce the habitat of a fish or wildlife species, cause a fish or wildlife population to drop below self-sustaining levels, threaten to eliminate a plant or animal community, reduce the number or restrict the range of a rare or endangered plant or animal or eliminate important examples of the major periods of California history or prehistory? **Determination: Less Than Significant Impact with Mitigation Incorporated.**

## Biological Resources

Based on the site conditions and lack of native habitat the proposed project will not impact native sensitive habitat or sensitive species. The project has no potential to impact any federally listed threatened or endangered species or its habitat or any essential fish habitat and would not result in impacts to special status species permanently, temporarily, directly, indirectly or cumulatively. No regulatory permits are required for the proposed project because it will not impact any State or federally protected species, sensitive habitats, streambeds, natural drainages, wetlands, waters of the U.S. or waters of the State. The results demonstrate that relatively few prehistoric archaeological sites or isolates were previously recorded on the level valley floor, in the area of Proposed Project.

## Cultural Resources/Tribal Cultural Resources

### *Cultural Resources*

The Cultural Resources Assessment prepared for the project site found the following:

1. No “historical resources” exist within or adjacent to the project area, and thus the project as currently proposed will not cause a substantial adverse change to any known “historical resources.”
2. No further cultural resources investigation is necessary for the proposed project unless construction plans undergo such changes as to include areas not covered by this study.
3. If buried cultural materials are encountered during any earth-moving operations associated with the project, all work within 50 feet of the discovery should be halted or diverted until a qualified archaeologist can evaluate the nature and significance of the finds.

### *Tribal Cultural Resources*

As required by AB 52, TVMWD reached out to a number of Tribes based on a list provided by the Native American Heritage Commission, to request consultation. Representatives of two tribes responded and the Cultural Resources Assessment for the proposed project were provided. One Tribal representative requested consultation to discuss the project in further detail. The second provided a list of mitigation measures to be incorporated into the Initial Study/Mitigated Negative Declaration. These have been slightly modified to indicate that both the Gabrieleño Band of Mission Indians–Kizh Nation and San Manuel Band of Mission Indians Cultural Resources Departments would be notified in the event that unknown resources are discovered during construction. In addition, during consultation with representatives of the Gabrieleño Band of Mission Indians–Kizh Nation requested that additional information regarding their traditional ancestral territory in which the project site is located, and that mitigation measures be revised to specifically address their concerns regarding the potential to uncover resources. The mitigation measures are included at the

end of Section 3.5, *Cultural Resources* and 3.18, *Tribal Cultural Resources* have been amended to reflect this request. Compliance with these measures would ensure that impacts to Cultural and/or Tribal Cultural Resources would be less than significant.

21(b) Does the project have impacts that are individually limited, but cumulatively considerable? ("Cumulatively considerable" means that the incremental effects of a project are considerable when viewed in connection with the effects of past projects, the effects of other current projects, and the effects of probable future projects)?  
**Determination: Less Than Significant Impact with Mitigation Incorporated.**

A significant impact may occur if the project, in conjunction with related projects, would result in impacts that are less than significant when viewed separately but would be significant when viewed together. When considering the proposed project in combination with other past, present, and reasonably foreseeable future projects in the vicinity of the project site, the proposed project does not have the potential to cause impacts that are cumulatively considerable. As detailed in Sections 3.1 through 3.20, the proposed project would not result in any significant impacts that cannot be mitigated to less than significant levels. For all issues, impacts associated with the proposed project are limited to the project site or its effect on the environment is negligible and would not result in a significant contribution to any cumulative impacts.

21(c) Does the project have environmental effects which will cause substantial adverse effects on human beings, either directly or indirectly? **Determination: Less Than Significant Impact with Mitigation Incorporated.**

The proposed project would not result in any identifiable substantial adverse effects on humans either directly or indirectly with the mitigation incorporated. The goal of the proposed project is to add a new groundwater production well to increase the reliability of TVMWD's ability to provide a reliable source of drinking water to area residents. The issues for which mitigation has been provided are designed to control potential harm to humans. With implementation of the required mitigation no substantial adverse effect to humans will result from carrying out the proposed project.

## 4 REFERENCES

California Air Pollution Control Officers Association. 2008. *CEQA and Climate Change: Evaluating and Addressing Greenhouse Gas Emissions from Projects Subject to the California Environmental Quality Act*. Sacramento, CA.

California Air Resources Board (CARB). 2013. *Mobile Source Emission Inventory – EMFAC2011 Frequently Asked Questions*. Available at:  
<https://www.arb.ca.gov/msei/emfac2011-faq.htm>.

\_\_\_\_\_. November 2017. *California's 2017 Climate Change Scoping Plan*.  
[https://www.arb.ca.gov/cc/scopingplan/scoping\\_plan\\_2017.pdf](https://www.arb.ca.gov/cc/scopingplan/scoping_plan_2017.pdf)

\_\_\_\_\_. December 2017. *California's 2017 Climate Change Scoping Plan*.  
[https://www.arb.ca.gov/cc/scopingplan/scoping\\_plan\\_2017.pdf](https://www.arb.ca.gov/cc/scopingplan/scoping_plan_2017.pdf)

\_\_\_\_\_. 2018. *California Greenhouse Gas Emission Inventory - 2018 Edition*.  
<https://www.arb.ca.gov/cc/inventory/data/data.htm>

\_\_\_\_\_. 2019. EMFAC 2014 Web Database. <https://www.arb.ca.gov/emfac/2014/>

California Climate Action Registry, 2009. *General Reporting Protocol*. Accessed March 2018, available at <https://sfenvironment.org/download/ccar-general-reporting-protocol-version-31-january-2009>.

California Department of Toxic Substances Control (DTSC), EnviroStor website, accessed August 12, 2019. <https://www.envirostor.dtsc.ca.gov/public/>

California Air Resources Board (CARB), *California Emissions Estimator Model User Guide: Version 2016.3.2*. 2017. <http://www.aqmd.gov/docs/defaultsource/caleemod/user's-guide---october-2017.pdf?sfvrsn=6>.

California Energy Commission. 2018. "Renewables Portfolio Standard." Sacramento, CA.  
<http://www.energy.ca.gov/portfolio/>

City of Claremont, 2009. *City of Claremont General Plan and Land Use Map*.

City of Claremont, 2015. *Natural Hazards Mitigation Plan*.

City of Upland, 2014, *Draft Cable Airport Land Use Compatibility Plan*.

CRM Tech, 2019. *Historical/Archaeological Resources Survey Report, TVMWD Miragrand Well Project, Assessor's Parcel Number 8671-009-019, City of Claremont, Los Angeles County, California*.

Federal Transit Administration (FTA), 2018. *Motor Fuel Use – 2017*,  
<https://www.fhwa.dot.gov/policyinformation/statistics/2016/mf21.cfm>

Hernandez Kroone Associates, Inc, 2019. *MiraGrand Well Site Traffic Memo*.

Intergovernmental Panel on Climate Change (IPCC). 2007. *Summary for Policymakers. In: Climate Change 2007: The Physical Science Basis. Contribution of Working Group I to the Fourth Assessment Report of the Intergovernmental Panel on Climate Change*.

JIG Consultants, 2019. *Preliminary Design Report Construction of Miragrand Groundwater Well*.

MD Acoustics, August 2019. *Miragrand Groundwater Well Noise Impact Study, City of Claremont, California*.

South Coast Air Quality Management District (SCAQMD). 2008a. *Final Localized Significance Threshold Methodology*.

<http://www.aqmd.gov/docs/defaultsource/ceqa/handbook/localized-significancethresholds/final-lst-methodologydocument.pdf?sfvrsn=2>.

\_\_\_\_\_ October 2008. *Draft Guidance Document – Interim CEQA Greenhouse Gas (GHG) Significance Threshold* [http://www.aqmd.gov/docs/defaultsource/ceqa/handbook/greenhouse-gases-\(ghg\)-ceqa-significancethresholds/ghgattachmente.pdf](http://www.aqmd.gov/docs/defaultsource/ceqa/handbook/greenhouse-gases-(ghg)-ceqa-significancethresholds/ghgattachmente.pdf)

\_\_\_\_\_ October 2009. *Appendix C – Mass Rate LST Look-up Tables*.

\_\_\_\_\_ September 2010. *Minutes for the GHG CEQA Significance Threshold Stakeholder Working Group #15*. [http://www.aqmd.gov/docs/defaultsource/ceqa/handbook/greenhouse-gases-\(ghg\)-ceqa-significance-thresholds/year-2008-2009/ghg-meeting-15/ghg-meeting-15-minutes.pdf?sfvrsn=2](http://www.aqmd.gov/docs/defaultsource/ceqa/handbook/greenhouse-gases-(ghg)-ceqa-significance-thresholds/year-2008-2009/ghg-meeting-15/ghg-meeting-15-minutes.pdf?sfvrsn=2) .

\_\_\_\_\_ March 2015. *SCAQMD Air Quality Significance Thresholds*. <http://www.aqmd.gov/docs/default-source/ceqa/handbook/scaqmd-air-qualitysignificance-thresholds.pdf>.

\_\_\_\_\_ June 2017. *2016 Air Quality Management Plan*.

Southern California Edison (SCE), June 2018. *2017 Sustainability Report*.

United States Energy Information Administration (EIA), 2018. “*California - Profile Overview*.” Last modified: November 15, 2018. <https://www.eia.gov/state/?sid=CA> .

US Environmental Protection Agency (EPA), May 2018. *Greenhouse Gas Equivalencies Calculator*. Last modified: May 25, 2018. <https://www.epa.gov/energy/greenhouse-gas-equivalencies-calculator>.

Wildermuth Environmental, 2017. *Strategic Plan for the Six Basins*.

## 5 MITIGATION MONITORING AND REPORTING PROGRAM

This Mitigation Monitoring and Reporting Program (MMRP) has been prepared to comply with Section 21081.6 of the California Environmental Quality Act (CEQA). Section 21081.6 requires that public agencies adopt a monitoring program for measures that are required to mitigate or avoid significant effects to the environment from the project.

As the lead agency, the Three Valleys Municipal Water District (TVMWD) will be responsible for monitoring compliance with all mitigation measures.

The MMRP serves three functions:

1. Assures completion of mitigation measures during project implementation.
2. Provides feedback to designated agencies and decision makers regarding the effectiveness of the mitigation measures.
3. Identifies the need for enforcement action before irreversible environmental damage occurs.

The MMRP includes a list of the mitigation measures to be implemented during construction and operation of the project; indicates the timeframe for completion of the measure and identifies who is responsible for carrying out the measure and who is responsible for monitoring that the measure is carried out.

TVMWD may modify the means by which a mitigation measure will be implemented or substitute a mitigation measure, as long as a modified or alternative measure successfully mitigate the impact to a less than significant level.



Mitigation Measures	Method of Verification	Timing of Verification	Responsible Party
<i>Air Quality</i>			
AQ-1 Construction contractors shall adhere to applicable measures set forth in SCAQMD Rule 403 including, but not limited to: <ul style="list-style-type: none"> <li>• All clearing, grading, earth-moving, or excavation activities shall cease when winds exceed 25 mph per SCAQMD guidelines in order to limit fugitive dust emissions.</li> <li>• The contractor shall ensure that all disturbed unpaved roads and disturbed areas within the project site are watered at least three (3) times daily during dry weather. Watering, with complete coverage of disturbed areas, shall occur at least three times a day, preferably in the mid-morning, afternoon, and after work is done for the day.</li> <li>• The contractor shall ensure that traffic speeds at the project site areas are limited to 15 miles per hour or less.</li> </ul>	Provide notes on all construction plans  Construction general contractor shall be responsible for enforcing compliance by subcontractors through reporting to TVMWD Project Manager	On-going during construction	TVMWD Project Manager
<i>Cultural Resources and Tribal Cultural Resources</i>			
<i>Cultural Resources</i> CUL-1 <u>Prior to commencement of project ground disturbing activities (e.g., clearing and grubbing, tree removal, pot-holing or augering, boring, grading, excavation, drilling and trenching) TVMWD shall retain a qualified archaeological monitor approved by the Gabrieleño Band of Mission Indians-Kizh Nation and is listed under the NAHC’s Tribal Contact list for the area of the project location. At the end of monitoring activities, the monitor shall submit a monitoring report that describes construction activities, location, soils, and othe</u>	Provide notes on all construction plans  Construction general contractor shall be responsible for enforcing compliance by subcontractors and in notifying the TVMWD Project Manager if resources are uncovered	On-going during earth moving and trenching activities	TVMWD Project Manager

Mitigation Measures	Method of Verification	Timing of Verification	Responsible Party
<p><u>r pertinent data; and any identified cultural material.</u></p> <p><u>Monitoring shall end when the project site grading and excavation activities are completed, or when the monitor concludes that the site has a low potential for impacting Tribal Cultural Resources.</u></p> <p>CUL-2 In the event that cultural resources are discovered during project activities, all work in the immediate vicinity of the find (within a 60-foot buffer) shall cease <del>and a qualified archaeologist meeting Secretary of Interior standards shall be hired to assess the find.</del> Work on the other portions of the project outside of the buffered area may continue during this assessment period. Additionally, the <u>Gabrieleño Band of Mission Indians-Kizh Nation and the San Manuel Band of Mission Indians Cultural Resources Department (SMBMI)</u> shall be contacted, regarding any pre-contact finds and be provided information after the archaeologist makes his/her initial assessment of the nature of the find, so as to provide Tribal input with regards to significance and treatment. (To be implemented in tandem with mitigation measure TCR-1)</p> <p>CUL-3 If significant pre-contact cultural resources, as defined by CEQA (as amended, 2015), are discovered and avoidance cannot be ensured, the archaeologist shall develop a Monitoring and Treatment Plan, the drafts of which shall be provided to the <u>Gabrieleño Band of Mission Indians-Kizh Nation and SMBMI</u> for review and comment, as detailed within TCR-1. The archaeologist shall monitor the remainder of the project and implement the Plan accordingly.</p> <p>CUL-4 If human remains or funerary objects are encountered during any activities associated with the project, work in the immediate vicinity (within a 100-foot buffer of the find) shall cease and the County Coroner shall be contacted pursuant to</p>	<p>TVMWD Project Manager will be responsible for notifying tribal representatives</p>		

Mitigation Measures	Method of Verification	Timing of Verification	Responsible Party
<p>State Health and Safety Code Section 7050.5 and that code enforced for the duration of the project. <u>If the coroner recognizes the human remains to be those of a Native American or has reason to believe that they are those of a Native American, he or she shall contact, by telephone within 24 hours, the Native American Heritage Commission (NAHC) and PRC 5097.98 shall be followed.</u></p> <p><i>Tribal Cultural Resources</i>                      Because the analyses of Cultural Resources and Tribal Cultural Resources are interconnected, mitigation measures specific to the issue of Tribal Cultural Resources are included here.</p> <p>TCR-1 The <u>Gabrieleño Band of Mission Indians-Kizh Nation and San Manuel Band of Mission Indians Cultural Resources Department (SMBMI)</u> shall be contacted, as detailed in CUL-1, of any pre-contact cultural resources discovered during project implementation, and be provided information regarding the nature of the find, so as to provide Tribal input with regards to significance and treatment. Should the find be deemed significant, as defined by CEQA, a Cultural Resources Monitoring and Treatment Plan (CRMTP) shall be created by the archaeologist, in coordination with <u>SMBMI, representatives of each tribe</u>, and all subsequent finds shall be subject to this CRMTP. The CRMTP shall <u>include a continuation of the monitoring activities as outlined in mitigation measure CUL-1.</u> <del>allow for a monitor to be present that represents SMBMI for the remainder of the project, should SMBMI elect to place a monitor on site.</del></p> <p>TCR-2 Any and all archaeological/cultural documents created as a part of the project (isolate records, site records, survey</p>			

Mitigation Measures	Method of Verification	Timing of Verification	Responsible Party
<p>reports, testing reports, etc.) shall be supplied to TVMWD the applicant and Lead Agency for dissemination to <u>Gabrieleño Band of Mission Indians-Kizh Nation and SMBMI</u>. The Lead Agency and/or applicant shall, in good faith, consult with <u>each of the Tribal representatives SMBMI</u> throughout the life of the project.</p>			
<i>Geology/ Soils/Paleo Resources</i>			
<p><i>Geology/Soils</i></p> <p>GEO-1 Prior to commencement of construction, the construction contractor shall prepare Stormwater Pollution Prevention Plan (SWPPP) for review by TVMWD; and submit a Notice of Intent (NOI) to the State Water Resources Control Board (SWRCB) who will issue a Waste Discharge Identification Number (WDID) for the project. A copy of the SWPPP must be available for review at the construction site and modified (if necessary) to address on-site issues, such as heavy storm events that may require additional measures should they arise.</p> <p><i>Paleontological Resources</i></p> <p>GEO-2 During well drilling, or excavation/trenching associated with other construction activities at the project site or as part of trenching for the new pipeline, should paleontological resources be uncovered, all work within a 50-foot radius shall cease and a qualified paleontologist shall be consulted to determine the significance of the find and if necessary, develop a plan to retrieve and curate the resources at an accredited museum.</p>	<p><i>Geology/Soils</i></p> <p>Construction contractor to prepare the SWPPP for review by TVMWD Project Manager and submittal of a Notice of Intent to the SWRCB</p> <p><i>Paleo Resources</i></p> <p>Construction general contractor shall be responsible for enforcing compliance by subcontractors and in notifying the TVMWD Project Manager if resources are uncovered</p>	<p>Prior to commencement of construction activities</p> <p>On-going during earthmoving/trenching activities</p>	<p>TVMWD Project Manager</p> <p>TVMWD Project Manager</p>

Mitigation Measures	Method of Verification	Timing of Verification	Responsible Party
	TVMWD Project Manager will be responsible for notifying tribal representatives		
<i>Hazards and Hazardous Materials</i>			
Regarding the potential to impair implementation of or physically interfere with an adopted emergency response/ evacuation plan, the Project Description includes the preparation of a traffic control plan (TCP) to be implemented during construction. Therefore, no mitigation is required.			
<i>Hydrology and Water Quality</i>			
Regarding water quality standards, mitigation measure GEO-1 in Section 3.7, Geology and Soils, requires the development and implementation - during all phases of construction - of Stormwater Pollution Prevention Plan (SWPPP) for review by TVMWD and submittal to the State Water Resources Control Board (SWRCB) who will issue a Waste Discharge Identification Number (WDID) for the project. A copy of the SWPPP must be kept on the project site during all construction activities.	Construction contractor to prepare the TCP for review by TVMWD Project Manager and submittal of a Notice of Intent to the SWRCB	Prior to commencement of construction activities	TVMWD Project Manager
<i>Noise</i>			
<i>Construction</i> NOI-1 Construction activities must follow the City's General Plan and the Noise Ordinance, which states that construction, repair or excavation work performed must occur within the	All measures shall appear on all construction plans	On-going during all phases of construction	TVMWD Project Manager

Mitigation Measures	Method of Verification	Timing of Verification	Responsible Party
<p>permissible hours. To further ensure that construction activities do not disrupt the adjacent land uses, the following measures will be taken:</p> <ol style="list-style-type: none"> <li>1. Typical construction activities will occur between the hours of 7AM and 5PM. Monday through Friday except during holidays.</li> <li>2. During construction, the contractor will ensure all construction equipment is equipped with appropriate noise attenuating devices.</li> <li>3. The contractor will locate equipment staging areas that will create the greatest distance between construction-related noise/vibration sources and sensitive receptors nearest the project site during all project construction.</li> <li>4. Idling equipment will be turned off when not in use.</li> <li>5. Equipment will be maintained so that vehicles and their loads are secured from rattling and banging.</li> <li>6. A 24-foot high noise barrier will be placed around the well where noted during well construction (see Noise Study Exhibit G).</li> <li>7. Nearby residences will be notified before 24-hour drilling and well development activities.</li> <li>8. Contact information will be posted on site to allow local residents to call. TVMWD may consult with the project noise consultant to determine if additional sound attenuation measures are needed.</li> </ol>	<p>for review and implementation by all contractors</p> <p>TVMWD Project Manager to conduct period site visits to ensure compliance</p> <p>Notification of nearby residents shall be done by the construction contractor under supervision of the TVMWD project manager</p>		
<p><i>Operation</i>                      The Noise Study concluded that constructing the well pump building with masonry block and interior acoustical tiles, noise attenuation of the well pump will ensure that noise levels are below the City's Standards set forth in the Municipal Code. Therefore, no mitigation for operation is required.</p>			

Mitigation Measures	Method of Verification	Timing of Verification	Responsible Party
<i>Transportation</i>			
Regarding the potential to impair implementation of or physically interfere with an adopted emergency response/ evacuation plan, the Project Description includes the preparation of a traffic control plan (TCP) to be implemented during construction. Therefore, no mitigation is required.			
<i>Utilities and Service Systems</i>			
USS-1 Prior to commencement of construction, the contractor shall prepare a Construction and Demolition disposal plan to the TVMWD. The plan shall include the name and location of the facility(s) that would accept C&D waste from the project site, thus diverting this waste from a landfill.	Construction contractor shall prepare the C&D Plan for review and approval of TVMWD	Prior to commencement of construction activities	TVMWD Project Manager
<i>Wildfire</i>			
Regarding the potential to impair implementation of or physically interfere with an adopted emergency response/ evacuation plan, the Project Description includes the preparation of a traffic control plan (TCP) to be implemented during construction. Therefore, no mitigation is required.			

APPENDIX A.1  
AIR QUALITY/GREENHOUSE GAS DATA SHEETS



TVMWD Pipeline - Los Angeles-South Coast County, Annual

**TVMWD Pipeline**  
**Los Angeles-South Coast County, Annual**

**1.0 Project Characteristics**

---

**1.1 Land Usage**

Land Uses	Size	Metric	Lot Acreage	Floor Surface Area	Population
Other Asphalt Surfaces	1.00	1000sqft	1.00	1,000.00	0

**1.2 Other Project Characteristics**

<b>Urbanization</b>	Urban	<b>Wind Speed (m/s)</b>	2.2	<b>Precipitation Freq (Days)</b>	33
<b>Climate Zone</b>	10			<b>Operational Year</b>	2022
<b>Utility Company</b>	Southern California Edison				
<b>CO2 Intensity (lb/MWhr)</b>	702.44	<b>CH4 Intensity (lb/MWhr)</b>	0.029	<b>N2O Intensity (lb/MWhr)</b>	0.006

**1.3 User Entered Comments & Non-Default Data**

- Project Characteristics -
- Land Use - Per Applicant
- Construction Phase - Per Contractor
- Off-road Equipment - per contractor
- Off-road Equipment -
- Construction Off-road Equipment Mitigation -

TVMWD Pipeline - Los Angeles-South Coast County, Annual

Table Name	Column Name	Default Value	New Value
tblLandUse	LotAcreage	0.02	1.00
tblOffRoadEquipment	HorsePower	81.00	84.00
tblOffRoadEquipment	HorsePower	172.00	89.00
tblOffRoadEquipment	HorsePower	16.00	46.00
tblOffRoadEquipment	LoadFactor	0.73	0.74
tblOffRoadEquipment	LoadFactor	0.42	0.20
tblOffRoadEquipment	LoadFactor	0.38	0.45
tblOffRoadEquipment	OffRoadEquipmentType	Generator Sets	Concrete/Industrial Saws
tblOffRoadEquipment	OffRoadEquipmentType	Forklifts	Other Construction Equipment
tblOffRoadEquipment	OffRoadEquipmentType	Welders	Dumpers/Tenders

**2.0 Emissions Summary**

---



TVMWD Pipeline - Los Angeles-South Coast County, Annual

Quarter	Start Date	End Date	Maximum Unmitigated ROG + NOX (tons/quarter)	Maximum Mitigated ROG + NOX (tons/quarter)
1	3-1-2020	5-31-2020	0.7308	0.7308
2	6-1-2020	8-31-2020	0.3981	0.3981
		Highest	0.7308	0.7308

2.2 Overall Operational

Unmitigated Operational

	ROG	NOx	CO	SO2	Fugitive PM10	Exhaust PM10	PM10 Total	Fugitive PM2.5	Exhaust PM2.5	PM2.5 Total	Bio- CO2	NBio- CO2	Total CO2	CH4	N2O	CO2e
Category	tons/yr										MT/yr					
Area	8.0000e-005	0.0000	1.0000e-005	0.0000		0.0000	0.0000		0.0000	0.0000	0.0000	2.0000e-005	2.0000e-005	0.0000	0.0000	3.0000e-005
Energy	0.0000	0.0000	0.0000	0.0000		0.0000	0.0000		0.0000	0.0000	0.0000	0.0000	0.0000	0.0000	0.0000	0.0000
Mobile	0.0000	0.0000	0.0000	0.0000	0.0000	0.0000	0.0000	0.0000	0.0000	0.0000	0.0000	0.0000	0.0000	0.0000	0.0000	0.0000
Waste						0.0000	0.0000		0.0000	0.0000	0.0000	0.0000	0.0000	0.0000	0.0000	0.0000
Water						0.0000	0.0000		0.0000	0.0000	0.0000	0.0000	0.0000	0.0000	0.0000	0.0000
<b>Total</b>	<b>8.0000e-005</b>	<b>0.0000</b>	<b>1.0000e-005</b>	<b>0.0000</b>	<b>0.0000</b>	<b>0.0000</b>	<b>0.0000</b>	<b>0.0000</b>	<b>0.0000</b>	<b>0.0000</b>	<b>0.0000</b>	<b>2.0000e-005</b>	<b>2.0000e-005</b>	<b>0.0000</b>	<b>0.0000</b>	<b>3.0000e-005</b>

TVMWD Pipeline - Los Angeles-South Coast County, Annual

**2.2 Overall Operational**

**Mitigated Operational**

	ROG	NOx	CO	SO2	Fugitive PM10	Exhaust PM10	PM10 Total	Fugitive PM2.5	Exhaust PM2.5	PM2.5 Total	Bio- CO2	NBio- CO2	Total CO2	CH4	N2O	CO2e
Category	tons/yr										MT/yr					
Area	8.0000e-005	0.0000	1.0000e-005	0.0000		0.0000	0.0000		0.0000	0.0000	0.0000	2.0000e-005	2.0000e-005	0.0000	0.0000	3.0000e-005
Energy	0.0000	0.0000	0.0000	0.0000		0.0000	0.0000		0.0000	0.0000	0.0000	0.0000	0.0000	0.0000	0.0000	0.0000
Mobile	0.0000	0.0000	0.0000	0.0000	0.0000	0.0000	0.0000	0.0000	0.0000	0.0000	0.0000	0.0000	0.0000	0.0000	0.0000	0.0000
Waste						0.0000	0.0000		0.0000	0.0000	0.0000	0.0000	0.0000	0.0000	0.0000	0.0000
Water						0.0000	0.0000		0.0000	0.0000	0.0000	0.0000	0.0000	0.0000	0.0000	0.0000
<b>Total</b>	<b>8.0000e-005</b>	<b>0.0000</b>	<b>1.0000e-005</b>	<b>0.0000</b>	<b>0.0000</b>	<b>0.0000</b>	<b>0.0000</b>	<b>0.0000</b>	<b>0.0000</b>	<b>0.0000</b>	<b>0.0000</b>	<b>2.0000e-005</b>	<b>2.0000e-005</b>	<b>0.0000</b>	<b>0.0000</b>	<b>3.0000e-005</b>

	ROG	NOx	CO	SO2	Fugitive PM10	Exhaust PM10	PM10 Total	Fugitive PM2.5	Exhaust PM2.5	PM2.5 Total	Bio- CO2	NBio-CO2	Total CO2	CH4	N2O	CO2e
Percent Reduction	0.00	0.00	0.00	0.00	0.00	0.00	0.00	0.00	0.00	0.00	0.00	0.00	0.00	0.00	0.00	0.00

**3.0 Construction Detail**

**Construction Phase**

Phase Number	Phase Name	Phase Type	Start Date	End Date	Num Days Week	Num Days	Phase Description
1	Building Construction	Building Construction	3/1/2020	7/17/2020	5	100	
2	Paving	Paving	7/18/2020	7/24/2020	5	5	

TVMWD Pipeline - Los Angeles-South Coast County, Annual

Acres of Grading (Site Preparation Phase): 0

Acres of Grading (Grading Phase): 0

Acres of Paving: 1

Residential Indoor: 0; Residential Outdoor: 0; Non-Residential Indoor: 0; Non-Residential Outdoor: 0; Striped Parking Area: 0 (Architectural Coating – sqft)

OffRoad Equipment

Phase Name	Offroad Equipment Type	Amount	Usage Hours	Horse Power	Load Factor
Building Construction	Forklifts	1	6.00	89	0.20
Paving	Cement and Mortar Mixers	1	6.00	9	0.56
Building Construction	Generator Sets	1	8.00	84	0.74
Building Construction	Concrete/Industrial Saws	1	6.00	84	0.74
Building Construction	Cranes	1	6.00	231	0.29
Building Construction	Other Construction Equipment	2	6.00	89	0.20
Building Construction	Welders	3	8.00	46	0.45
Paving	Pavers	1	6.00	130	0.42
Paving	Rollers	1	7.00	80	0.38
Building Construction	Tractors/Loaders/Backhoes	1	6.00	97	0.37
Paving	Tractors/Loaders/Backhoes	1	8.00	97	0.37
Paving	Paving Equipment	1	8.00	132	0.36
Building Construction	Dumpers/Tenders	1	6.00	46	0.45

Trips and VMT

TVMWD Pipeline - Los Angeles-South Coast County, Annual

Phase Name	Offroad Equipment Count	Worker Trip Number	Vendor Trip Number	Hauling Trip Number	Worker Trip Length	Vendor Trip Length	Hauling Trip Length	Worker Vehicle Class	Vendor Vehicle Class	Hauling Vehicle Class
Building Construction	11	0.00	0.00	0.00	14.70	6.90	20.00	LD_Mix	HDT_Mix	HHDT
Paving	5	13.00	0.00	0.00	14.70	6.90	20.00	LD_Mix	HDT_Mix	HHDT

**3.1 Mitigation Measures Construction**

Water Exposed Area

**3.2 Building Construction - 2020**

**Unmitigated Construction On-Site**

	ROG	NOx	CO	SO2	Fugitive PM10	Exhaust PM10	PM10 Total	Fugitive PM2.5	Exhaust PM2.5	PM2.5 Total	Bio- CO2	NBio- CO2	Total CO2	CH4	N2O	CO2e
Category	tons/yr										MT/yr					
Off-Road	0.1302	0.9818	0.8926	1.4600e-003		0.0559	0.0559		0.0539	0.0539	0.0000	122.0529	122.0529	0.0215	0.0000	122.5893
<b>Total</b>	<b>0.1302</b>	<b>0.9818</b>	<b>0.8926</b>	<b>1.4600e-003</b>		<b>0.0559</b>	<b>0.0559</b>		<b>0.0539</b>	<b>0.0539</b>	<b>0.0000</b>	<b>122.0529</b>	<b>122.0529</b>	<b>0.0215</b>	<b>0.0000</b>	<b>122.5893</b>

TVMWD Pipeline - Los Angeles-South Coast County, Annual

**3.2 Building Construction - 2020**

**Unmitigated Construction Off-Site**

	ROG	NOx	CO	SO2	Fugitive PM10	Exhaust PM10	PM10 Total	Fugitive PM2.5	Exhaust PM2.5	PM2.5 Total	Bio- CO2	NBio- CO2	Total CO2	CH4	N2O	CO2e
Category	tons/yr										MT/yr					
Hauling	0.0000	0.0000	0.0000	0.0000	0.0000	0.0000	0.0000	0.0000	0.0000	0.0000	0.0000	0.0000	0.0000	0.0000	0.0000	0.0000
Vendor	0.0000	0.0000	0.0000	0.0000	0.0000	0.0000	0.0000	0.0000	0.0000	0.0000	0.0000	0.0000	0.0000	0.0000	0.0000	0.0000
Worker	0.0000	0.0000	0.0000	0.0000	0.0000	0.0000	0.0000	0.0000	0.0000	0.0000	0.0000	0.0000	0.0000	0.0000	0.0000	0.0000
<b>Total</b>	<b>0.0000</b>	<b>0.0000</b>	<b>0.0000</b>	<b>0.0000</b>	<b>0.0000</b>	<b>0.0000</b>	<b>0.0000</b>	<b>0.0000</b>	<b>0.0000</b>	<b>0.0000</b>	<b>0.0000</b>	<b>0.0000</b>	<b>0.0000</b>	<b>0.0000</b>	<b>0.0000</b>	<b>0.0000</b>

**Mitigated Construction On-Site**

	ROG	NOx	CO	SO2	Fugitive PM10	Exhaust PM10	PM10 Total	Fugitive PM2.5	Exhaust PM2.5	PM2.5 Total	Bio- CO2	NBio- CO2	Total CO2	CH4	N2O	CO2e
Category	tons/yr										MT/yr					
Off-Road	0.1302	0.9818	0.8926	1.4600e-003		0.0559	0.0559		0.0539	0.0539	0.0000	122.0527	122.0527	0.0215	0.0000	122.5891
<b>Total</b>	<b>0.1302</b>	<b>0.9818</b>	<b>0.8926</b>	<b>1.4600e-003</b>		<b>0.0559</b>	<b>0.0559</b>		<b>0.0539</b>	<b>0.0539</b>	<b>0.0000</b>	<b>122.0527</b>	<b>122.0527</b>	<b>0.0215</b>	<b>0.0000</b>	<b>122.5891</b>



TVMWD Pipeline - Los Angeles-South Coast County, Annual

**3.2 Building Construction - 2020**

**Mitigated Construction Off-Site**

	ROG	NOx	CO	SO2	Fugitive PM10	Exhaust PM10	PM10 Total	Fugitive PM2.5	Exhaust PM2.5	PM2.5 Total	Bio- CO2	NBio- CO2	Total CO2	CH4	N2O	CO2e
Category	tons/yr										MT/yr					
Hauling	0.0000	0.0000	0.0000	0.0000	0.0000	0.0000	0.0000	0.0000	0.0000	0.0000	0.0000	0.0000	0.0000	0.0000	0.0000	0.0000
Vendor	0.0000	0.0000	0.0000	0.0000	0.0000	0.0000	0.0000	0.0000	0.0000	0.0000	0.0000	0.0000	0.0000	0.0000	0.0000	0.0000
Worker	0.0000	0.0000	0.0000	0.0000	0.0000	0.0000	0.0000	0.0000	0.0000	0.0000	0.0000	0.0000	0.0000	0.0000	0.0000	0.0000
<b>Total</b>	<b>0.0000</b>	<b>0.0000</b>	<b>0.0000</b>	<b>0.0000</b>	<b>0.0000</b>	<b>0.0000</b>	<b>0.0000</b>	<b>0.0000</b>	<b>0.0000</b>	<b>0.0000</b>	<b>0.0000</b>	<b>0.0000</b>	<b>0.0000</b>	<b>0.0000</b>	<b>0.0000</b>	<b>0.0000</b>

**3.3 Paving - 2020**

**Unmitigated Construction On-Site**

	ROG	NOx	CO	SO2	Fugitive PM10	Exhaust PM10	PM10 Total	Fugitive PM2.5	Exhaust PM2.5	PM2.5 Total	Bio- CO2	NBio- CO2	Total CO2	CH4	N2O	CO2e
Category	tons/yr										MT/yr					
Off-Road	2.1000e-003	0.0211	0.0222	3.0000e-005		1.1700e-003	1.1700e-003		1.0800e-003	1.0800e-003	0.0000	2.9414	2.9414	9.3000e-004	0.0000	2.9647
Paving	1.3100e-003					0.0000	0.0000		0.0000	0.0000	0.0000	0.0000	0.0000	0.0000	0.0000	0.0000
<b>Total</b>	<b>3.4100e-003</b>	<b>0.0211</b>	<b>0.0222</b>	<b>3.0000e-005</b>		<b>1.1700e-003</b>	<b>1.1700e-003</b>		<b>1.0800e-003</b>	<b>1.0800e-003</b>	<b>0.0000</b>	<b>2.9414</b>	<b>2.9414</b>	<b>9.3000e-004</b>	<b>0.0000</b>	<b>2.9647</b>

TVMWD Pipeline - Los Angeles-South Coast County, Annual

**3.3 Paving - 2020**

**Unmitigated Construction Off-Site**

	ROG	NOx	CO	SO2	Fugitive PM10	Exhaust PM10	PM10 Total	Fugitive PM2.5	Exhaust PM2.5	PM2.5 Total	Bio- CO2	NBio- CO2	Total CO2	CH4	N2O	CO2e
Category	tons/yr										MT/yr					
Hauling	0.0000	0.0000	0.0000	0.0000	0.0000	0.0000	0.0000	0.0000	0.0000	0.0000	0.0000	0.0000	0.0000	0.0000	0.0000	0.0000
Vendor	0.0000	0.0000	0.0000	0.0000	0.0000	0.0000	0.0000	0.0000	0.0000	0.0000	0.0000	0.0000	0.0000	0.0000	0.0000	0.0000
Worker	1.5000e-004	1.2000e-004	1.3400e-003	0.0000	3.6000e-004	0.0000	3.6000e-004	9.0000e-005	0.0000	1.0000e-004	0.0000	0.3319	0.3319	1.0000e-005	0.0000	0.3322
<b>Total</b>	<b>1.5000e-004</b>	<b>1.2000e-004</b>	<b>1.3400e-003</b>	<b>0.0000</b>	<b>3.6000e-004</b>	<b>0.0000</b>	<b>3.6000e-004</b>	<b>9.0000e-005</b>	<b>0.0000</b>	<b>1.0000e-004</b>	<b>0.0000</b>	<b>0.3319</b>	<b>0.3319</b>	<b>1.0000e-005</b>	<b>0.0000</b>	<b>0.3322</b>

**Mitigated Construction On-Site**

	ROG	NOx	CO	SO2	Fugitive PM10	Exhaust PM10	PM10 Total	Fugitive PM2.5	Exhaust PM2.5	PM2.5 Total	Bio- CO2	NBio- CO2	Total CO2	CH4	N2O	CO2e
Category	tons/yr										MT/yr					
Off-Road	2.1000e-003	0.0211	0.0222	3.0000e-005		1.1700e-003	1.1700e-003		1.0800e-003	1.0800e-003	0.0000	2.9414	2.9414	9.3000e-004	0.0000	2.9647
Paving	1.3100e-003					0.0000	0.0000		0.0000	0.0000	0.0000	0.0000	0.0000	0.0000	0.0000	0.0000
<b>Total</b>	<b>3.4100e-003</b>	<b>0.0211</b>	<b>0.0222</b>	<b>3.0000e-005</b>		<b>1.1700e-003</b>	<b>1.1700e-003</b>		<b>1.0800e-003</b>	<b>1.0800e-003</b>	<b>0.0000</b>	<b>2.9414</b>	<b>2.9414</b>	<b>9.3000e-004</b>	<b>0.0000</b>	<b>2.9647</b>

TVMWD Pipeline - Los Angeles-South Coast County, Annual

**3.3 Paving - 2020**

**Mitigated Construction Off-Site**

	ROG	NOx	CO	SO2	Fugitive PM10	Exhaust PM10	PM10 Total	Fugitive PM2.5	Exhaust PM2.5	PM2.5 Total	Bio- CO2	NBio- CO2	Total CO2	CH4	N2O	CO2e
Category	tons/yr										MT/yr					
Hauling	0.0000	0.0000	0.0000	0.0000	0.0000	0.0000	0.0000	0.0000	0.0000	0.0000	0.0000	0.0000	0.0000	0.0000	0.0000	0.0000
Vendor	0.0000	0.0000	0.0000	0.0000	0.0000	0.0000	0.0000	0.0000	0.0000	0.0000	0.0000	0.0000	0.0000	0.0000	0.0000	0.0000
Worker	1.5000e-004	1.2000e-004	1.3400e-003	0.0000	3.6000e-004	0.0000	3.6000e-004	9.0000e-005	0.0000	1.0000e-004	0.0000	0.3319	0.3319	1.0000e-005	0.0000	0.3322
<b>Total</b>	<b>1.5000e-004</b>	<b>1.2000e-004</b>	<b>1.3400e-003</b>	<b>0.0000</b>	<b>3.6000e-004</b>	<b>0.0000</b>	<b>3.6000e-004</b>	<b>9.0000e-005</b>	<b>0.0000</b>	<b>1.0000e-004</b>	<b>0.0000</b>	<b>0.3319</b>	<b>0.3319</b>	<b>1.0000e-005</b>	<b>0.0000</b>	<b>0.3322</b>

**4.0 Operational Detail - Mobile**

---

**4.1 Mitigation Measures Mobile**

TVMWD Pipeline - Los Angeles-South Coast County, Annual

	ROG	NOx	CO	SO2	Fugitive PM10	Exhaust PM10	PM10 Total	Fugitive PM2.5	Exhaust PM2.5	PM2.5 Total	Bio- CO2	NBio- CO2	Total CO2	CH4	N2O	CO2e
Category	tons/yr										MT/yr					
Mitigated	0.0000	0.0000	0.0000	0.0000	0.0000	0.0000	0.0000	0.0000	0.0000	0.0000	0.0000	0.0000	0.0000	0.0000	0.0000	0.0000
Unmitigated	0.0000	0.0000	0.0000	0.0000	0.0000	0.0000	0.0000	0.0000	0.0000	0.0000	0.0000	0.0000	0.0000	0.0000	0.0000	0.0000

4.2 Trip Summary Information

Land Use	Average Daily Trip Rate			Unmitigated	Mitigated
	Weekday	Saturday	Sunday	Annual VMT	Annual VMT
Other Asphalt Surfaces	0.00	0.00	0.00		
Total	0.00	0.00	0.00		

4.3 Trip Type Information

Land Use	Miles			Trip %			Trip Purpose %		
	H-W or C-W	H-S or C-C	H-O or C-NW	H-W or C-W	H-S or C-C	H-O or C-NW	Primary	Diverted	Pass-by
Other Asphalt Surfaces	16.60	8.40	6.90	0.00	0.00	0.00	0	0	0

4.4 Fleet Mix

Land Use	LDA	LDT1	LDT2	MDV	LHD1	LHD2	MHD	HHD	OBUS	UBUS	MCY	SBUS	MH
Other Asphalt Surfaces	0.546501	0.044961	0.204016	0.120355	0.015740	0.006196	0.020131	0.030678	0.002515	0.002201	0.005142	0.000687	0.000876

5.0 Energy Detail

Historical Energy Use: N



TVMWD Pipeline - Los Angeles-South Coast County, Annual

**5.2 Energy by Land Use - Natural Gas**

**Mitigated**

	Natural Gas Use	ROG	NOx	CO	SO2	Fugitive PM10	Exhaust PM10	PM10 Total	Fugitive PM2.5	Exhaust PM2.5	PM2.5 Total	Bio- CO2	NBio- CO2	Total CO2	CH4	N2O	CO2e	
Land Use	kBTU/yr	tons/yr										MT/yr						
Other Asphalt Surfaces	0	0.0000	0.0000	0.0000	0.0000		0.0000	0.0000		0.0000	0.0000	0.0000	0.0000	0.0000	0.0000	0.0000	0.0000	0.0000
<b>Total</b>		<b>0.0000</b>	<b>0.0000</b>	<b>0.0000</b>	<b>0.0000</b>		<b>0.0000</b>	<b>0.0000</b>		<b>0.0000</b>	<b>0.0000</b>	<b>0.0000</b>	<b>0.0000</b>	<b>0.0000</b>	<b>0.0000</b>	<b>0.0000</b>	<b>0.0000</b>	<b>0.0000</b>

**5.3 Energy by Land Use - Electricity**

**Unmitigated**

	Electricity Use	Total CO2	CH4	N2O	CO2e
Land Use	kWh/yr	MT/yr			
Other Asphalt Surfaces	0	0.0000	0.0000	0.0000	0.0000
<b>Total</b>		<b>0.0000</b>	<b>0.0000</b>	<b>0.0000</b>	<b>0.0000</b>

TVMWD Pipeline - Los Angeles-South Coast County, Annual

**5.3 Energy by Land Use - Electricity**

**Mitigated**

	Electricity Use	Total CO2	CH4	N2O	CO2e
Land Use	kWh/yr	MT/yr			
Other Asphalt Surfaces	0	0.0000	0.0000	0.0000	0.0000
<b>Total</b>		<b>0.0000</b>	<b>0.0000</b>	<b>0.0000</b>	<b>0.0000</b>

**6.0 Area Detail**

**6.1 Mitigation Measures Area**

	ROG	NOx	CO	SO2	Fugitive PM10	Exhaust PM10	PM10 Total	Fugitive PM2.5	Exhaust PM2.5	PM2.5 Total	Bio- CO2	NBio- CO2	Total CO2	CH4	N2O	CO2e
Category	tons/yr										MT/yr					
Mitigated	8.0000e-005	0.0000	1.0000e-005	0.0000		0.0000	0.0000		0.0000	0.0000	0.0000	2.0000e-005	2.0000e-005	0.0000	0.0000	3.0000e-005
Unmitigated	8.0000e-005	0.0000	1.0000e-005	0.0000		0.0000	0.0000		0.0000	0.0000	0.0000	2.0000e-005	2.0000e-005	0.0000	0.0000	3.0000e-005

TVMWD Pipeline - Los Angeles-South Coast County, Annual

**6.2 Area by SubCategory**

**Unmitigated**

	ROG	NOx	CO	SO2	Fugitive PM10	Exhaust PM10	PM10 Total	Fugitive PM2.5	Exhaust PM2.5	PM2.5 Total	Bio- CO2	NBio- CO2	Total CO2	CH4	N2O	CO2e
SubCategory	tons/yr										MT/yr					
Architectural Coating	1.0000e-005					0.0000	0.0000		0.0000	0.0000	0.0000	0.0000	0.0000	0.0000	0.0000	0.0000
Consumer Products	6.0000e-005					0.0000	0.0000		0.0000	0.0000	0.0000	0.0000	0.0000	0.0000	0.0000	0.0000
Landscaping	0.0000	0.0000	1.0000e-005	0.0000		0.0000	0.0000		0.0000	0.0000	0.0000	2.0000e-005	2.0000e-005	0.0000	0.0000	3.0000e-005
<b>Total</b>	<b>7.0000e-005</b>	<b>0.0000</b>	<b>1.0000e-005</b>	<b>0.0000</b>		<b>0.0000</b>	<b>0.0000</b>		<b>0.0000</b>	<b>0.0000</b>	<b>0.0000</b>	<b>2.0000e-005</b>	<b>2.0000e-005</b>	<b>0.0000</b>	<b>0.0000</b>	<b>3.0000e-005</b>

**Mitigated**

	ROG	NOx	CO	SO2	Fugitive PM10	Exhaust PM10	PM10 Total	Fugitive PM2.5	Exhaust PM2.5	PM2.5 Total	Bio- CO2	NBio- CO2	Total CO2	CH4	N2O	CO2e
SubCategory	tons/yr										MT/yr					
Architectural Coating	1.0000e-005					0.0000	0.0000		0.0000	0.0000	0.0000	0.0000	0.0000	0.0000	0.0000	0.0000
Consumer Products	6.0000e-005					0.0000	0.0000		0.0000	0.0000	0.0000	0.0000	0.0000	0.0000	0.0000	0.0000
Landscaping	0.0000	0.0000	1.0000e-005	0.0000		0.0000	0.0000		0.0000	0.0000	0.0000	2.0000e-005	2.0000e-005	0.0000	0.0000	3.0000e-005
<b>Total</b>	<b>7.0000e-005</b>	<b>0.0000</b>	<b>1.0000e-005</b>	<b>0.0000</b>		<b>0.0000</b>	<b>0.0000</b>		<b>0.0000</b>	<b>0.0000</b>	<b>0.0000</b>	<b>2.0000e-005</b>	<b>2.0000e-005</b>	<b>0.0000</b>	<b>0.0000</b>	<b>3.0000e-005</b>

**7.0 Water Detail**



TVMWD Pipeline - Los Angeles-South Coast County, Annual

**7.1 Mitigation Measures Water**

	Total CO2	CH4	N2O	CO2e
Category	MT/yr			
Mitigated	0.0000	0.0000	0.0000	0.0000
Unmitigated	0.0000	0.0000	0.0000	0.0000

**7.2 Water by Land Use**

**Unmitigated**

	Indoor/Outdoor Use	Total CO2	CH4	N2O	CO2e
Land Use	Mgal	MT/yr			
Other Asphalt Surfaces	0 / 0	0.0000	0.0000	0.0000	0.0000
<b>Total</b>		<b>0.0000</b>	<b>0.0000</b>	<b>0.0000</b>	<b>0.0000</b>

TVMWD Pipeline - Los Angeles-South Coast County, Annual

**7.2 Water by Land Use**

**Mitigated**

	Indoor/Outdoor Use	Total CO2	CH4	N2O	CO2e
Land Use	Mgal	MT/yr			
Other Asphalt Surfaces	0 / 0	0.0000	0.0000	0.0000	0.0000
<b>Total</b>		<b>0.0000</b>	<b>0.0000</b>	<b>0.0000</b>	<b>0.0000</b>

**8.0 Waste Detail**

---

**8.1 Mitigation Measures Waste**

**Category/Year**

	Total CO2	CH4	N2O	CO2e
	MT/yr			
Mitigated	0.0000	0.0000	0.0000	0.0000
Unmitigated	0.0000	0.0000	0.0000	0.0000

TVMWD Pipeline - Los Angeles-South Coast County, Annual

**8.2 Waste by Land Use**

**Unmitigated**

	Waste Disposed	Total CO2	CH4	N2O	CO2e
Land Use	tons	MT/yr			
Other Asphalt Surfaces	0	0.0000	0.0000	0.0000	0.0000
<b>Total</b>		<b>0.0000</b>	<b>0.0000</b>	<b>0.0000</b>	<b>0.0000</b>

**Mitigated**

	Waste Disposed	Total CO2	CH4	N2O	CO2e
Land Use	tons	MT/yr			
Other Asphalt Surfaces	0	0.0000	0.0000	0.0000	0.0000
<b>Total</b>		<b>0.0000</b>	<b>0.0000</b>	<b>0.0000</b>	<b>0.0000</b>

**9.0 Operational Offroad**

---

Equipment Type	Number	Hours/Day	Days/Year	Horse Power	Load Factor	Fuel Type
----------------	--------	-----------	-----------	-------------	-------------	-----------

TVMWD Pipeline - Los Angeles-South Coast County, Annual

### 10.0 Stationary Equipment

---

#### Fire Pumps and Emergency Generators

Equipment Type	Number	Hours/Day	Hours/Year	Horse Power	Load Factor	Fuel Type
----------------	--------	-----------	------------	-------------	-------------	-----------

#### Boilers

Equipment Type	Number	Heat Input/Day	Heat Input/Year	Boiler Rating	Fuel Type
----------------	--------	----------------	-----------------	---------------	-----------

#### User Defined Equipment

Equipment Type	Number
----------------	--------

### 11.0 Vegetation

---

TVMWD Pipeline - Los Angeles-South Coast County, Summer

**TVMWD Pipeline**  
**Los Angeles-South Coast County, Summer**

**1.0 Project Characteristics**

---

**1.1 Land Usage**

Land Uses	Size	Metric	Lot Acreage	Floor Surface Area	Population
Other Asphalt Surfaces	1.00	1000sqft	1.00	1,000.00	0

**1.2 Other Project Characteristics**

<b>Urbanization</b>	Urban	<b>Wind Speed (m/s)</b>	2.2	<b>Precipitation Freq (Days)</b>	33
<b>Climate Zone</b>	10			<b>Operational Year</b>	2022
<b>Utility Company</b>	Southern California Edison				
<b>CO2 Intensity (lb/MWhr)</b>	702.44	<b>CH4 Intensity (lb/MWhr)</b>	0.029	<b>N2O Intensity (lb/MWhr)</b>	0.006

**1.3 User Entered Comments & Non-Default Data**

- Project Characteristics -
- Land Use - Per Applicant
- Construction Phase - Per Contractor
- Off-road Equipment - per contractor
- Off-road Equipment -
- Construction Off-road Equipment Mitigation -

TVMWD Pipeline - Los Angeles-South Coast County, Summer

Table Name	Column Name	Default Value	New Value
tblLandUse	LotAcreage	0.02	1.00
tblOffRoadEquipment	HorsePower	81.00	84.00
tblOffRoadEquipment	HorsePower	172.00	89.00
tblOffRoadEquipment	HorsePower	16.00	46.00
tblOffRoadEquipment	LoadFactor	0.73	0.74
tblOffRoadEquipment	LoadFactor	0.42	0.20
tblOffRoadEquipment	LoadFactor	0.38	0.45
tblOffRoadEquipment	OffRoadEquipmentType	Generator Sets	Concrete/Industrial Saws
tblOffRoadEquipment	OffRoadEquipmentType	Forklifts	Other Construction Equipment
tblOffRoadEquipment	OffRoadEquipmentType	Welders	Dumpers/Tenders

**2.0 Emissions Summary**

---



TVMWD Pipeline - Los Angeles-South Coast County, Summer

**2.2 Overall Operational**

**Unmitigated Operational**

	ROG	NOx	CO	SO2	Fugitive PM10	Exhaust PM10	PM10 Total	Fugitive PM2.5	Exhaust PM2.5	PM2.5 Total	Bio- CO2	NBio- CO2	Total CO2	CH4	N2O	CO2e
Category	lb/day										lb/day					
Area	4.4000e-004	0.0000	1.0000e-004	0.0000		0.0000	0.0000		0.0000	0.0000		2.2000e-004	2.2000e-004	0.0000		2.3000e-004
Energy	0.0000	0.0000	0.0000	0.0000		0.0000	0.0000		0.0000	0.0000		0.0000	0.0000	0.0000	0.0000	0.0000
Mobile	0.0000	0.0000	0.0000	0.0000	0.0000	0.0000	0.0000	0.0000	0.0000	0.0000		0.0000	0.0000	0.0000		0.0000
<b>Total</b>	<b>4.4000e-004</b>	<b>0.0000</b>	<b>1.0000e-004</b>	<b>0.0000</b>	<b>0.0000</b>	<b>0.0000</b>	<b>0.0000</b>	<b>0.0000</b>	<b>0.0000</b>	<b>0.0000</b>		<b>2.2000e-004</b>	<b>2.2000e-004</b>	<b>0.0000</b>	<b>0.0000</b>	<b>2.3000e-004</b>

**Mitigated Operational**

	ROG	NOx	CO	SO2	Fugitive PM10	Exhaust PM10	PM10 Total	Fugitive PM2.5	Exhaust PM2.5	PM2.5 Total	Bio- CO2	NBio- CO2	Total CO2	CH4	N2O	CO2e
Category	lb/day										lb/day					
Area	4.4000e-004	0.0000	1.0000e-004	0.0000		0.0000	0.0000		0.0000	0.0000		2.2000e-004	2.2000e-004	0.0000		2.3000e-004
Energy	0.0000	0.0000	0.0000	0.0000		0.0000	0.0000		0.0000	0.0000		0.0000	0.0000	0.0000	0.0000	0.0000
Mobile	0.0000	0.0000	0.0000	0.0000	0.0000	0.0000	0.0000	0.0000	0.0000	0.0000		0.0000	0.0000	0.0000		0.0000
<b>Total</b>	<b>4.4000e-004</b>	<b>0.0000</b>	<b>1.0000e-004</b>	<b>0.0000</b>	<b>0.0000</b>	<b>0.0000</b>	<b>0.0000</b>	<b>0.0000</b>	<b>0.0000</b>	<b>0.0000</b>		<b>2.2000e-004</b>	<b>2.2000e-004</b>	<b>0.0000</b>	<b>0.0000</b>	<b>2.3000e-004</b>



TVMWD Pipeline - Los Angeles-South Coast County, Summer

	ROG	NOx	CO	SO2	Fugitive PM10	Exhaust PM10	PM10 Total	Fugitive PM2.5	Exhaust PM2.5	PM2.5 Total	Bio- CO2	NBio-CO2	Total CO2	CH4	N2O	CO2e
Percent Reduction	0.00	0.00	0.00	0.00	0.00	0.00	0.00	0.00	0.00	0.00	0.00	0.00	0.00	0.00	0.00	0.00

**3.0 Construction Detail**

**Construction Phase**

Phase Number	Phase Name	Phase Type	Start Date	End Date	Num Days Week	Num Days	Phase Description
1	Building Construction	Building Construction	3/1/2020	7/17/2020	5	100	
2	Paving	Paving	7/18/2020	7/24/2020	5	5	

**Acres of Grading (Site Preparation Phase): 0**

**Acres of Grading (Grading Phase): 0**

**Acres of Paving: 1**

**Residential Indoor: 0; Residential Outdoor: 0; Non-Residential Indoor: 0; Non-Residential Outdoor: 0; Striped Parking Area: 0 (Architectural Coating – sqft)**

**OffRoad Equipment**

TVMWD Pipeline - Los Angeles-South Coast County, Summer

Phase Name	Offroad Equipment Type	Amount	Usage Hours	Horse Power	Load Factor
Building Construction	Forklifts	1	6.00	89	0.20
Paving	Cement and Mortar Mixers	1	6.00	9	0.56
Building Construction	Generator Sets	1	8.00	84	0.74
Building Construction	Concrete/Industrial Saws	1	6.00	84	0.74
Building Construction	Cranes	1	6.00	231	0.29
Building Construction	Other Construction Equipment	2	6.00	89	0.20
Building Construction	Welders	3	8.00	46	0.45
Paving	Pavers	1	6.00	130	0.42
Paving	Rollers	1	7.00	80	0.38
Building Construction	Tractors/Loaders/Backhoes	1	6.00	97	0.37
Paving	Tractors/Loaders/Backhoes	1	8.00	97	0.37
Paving	Paving Equipment	1	8.00	132	0.36
Building Construction	Dumpers/Tenders	1	6.00	46	0.45

**Trips and VMT**

Phase Name	Offroad Equipment Count	Worker Trip Number	Vendor Trip Number	Hauling Trip Number	Worker Trip Length	Vendor Trip Length	Hauling Trip Length	Worker Vehicle Class	Vendor Vehicle Class	Hauling Vehicle Class
Building Construction	11	0.00	0.00	0.00	14.70	6.90	20.00	LD_Mix	HDT_Mix	HHDT
Paving	5	13.00	0.00	0.00	14.70	6.90	20.00	LD_Mix	HDT_Mix	HHDT

**3.1 Mitigation Measures Construction**

Water Exposed Area

TVMWD Pipeline - Los Angeles-South Coast County, Summer

**3.2 Building Construction - 2020**

**Unmitigated Construction On-Site**

	ROG	NOx	CO	SO2	Fugitive PM10	Exhaust PM10	PM10 Total	Fugitive PM2.5	Exhaust PM2.5	PM2.5 Total	Bio- CO2	NBio- CO2	Total CO2	CH4	N2O	CO2e
Category	lb/day										lb/day					
Off-Road	2.6047	19.6358	17.8521	0.0293		1.1187	1.1187		1.0783	1.0783		2,690.8055	2,690.8055	0.4730		2,702.6308
<b>Total</b>	<b>2.6047</b>	<b>19.6358</b>	<b>17.8521</b>	<b>0.0293</b>		<b>1.1187</b>	<b>1.1187</b>		<b>1.0783</b>	<b>1.0783</b>		<b>2,690.8055</b>	<b>2,690.8055</b>	<b>0.4730</b>		<b>2,702.6308</b>

**Unmitigated Construction Off-Site**

	ROG	NOx	CO	SO2	Fugitive PM10	Exhaust PM10	PM10 Total	Fugitive PM2.5	Exhaust PM2.5	PM2.5 Total	Bio- CO2	NBio- CO2	Total CO2	CH4	N2O	CO2e
Category	lb/day										lb/day					
Hauling	0.0000	0.0000	0.0000	0.0000	0.0000	0.0000	0.0000	0.0000	0.0000	0.0000		0.0000	0.0000	0.0000		0.0000
Vendor	0.0000	0.0000	0.0000	0.0000	0.0000	0.0000	0.0000	0.0000	0.0000	0.0000		0.0000	0.0000	0.0000		0.0000
Worker	0.0000	0.0000	0.0000	0.0000	0.0000	0.0000	0.0000	0.0000	0.0000	0.0000		0.0000	0.0000	0.0000		0.0000
<b>Total</b>	<b>0.0000</b>	<b>0.0000</b>	<b>0.0000</b>	<b>0.0000</b>	<b>0.0000</b>	<b>0.0000</b>	<b>0.0000</b>	<b>0.0000</b>	<b>0.0000</b>	<b>0.0000</b>		<b>0.0000</b>	<b>0.0000</b>	<b>0.0000</b>		<b>0.0000</b>

TVMWD Pipeline - Los Angeles-South Coast County, Summer

**3.2 Building Construction - 2020**

**Mitigated Construction On-Site**

	ROG	NOx	CO	SO2	Fugitive PM10	Exhaust PM10	PM10 Total	Fugitive PM2.5	Exhaust PM2.5	PM2.5 Total	Bio- CO2	NBio- CO2	Total CO2	CH4	N2O	CO2e
Category	lb/day										lb/day					
Off-Road	2.6047	19.6358	17.8521	0.0293		1.1187	1.1187		1.0783	1.0783	0.0000	2,690.8055	2,690.8055	0.4730		2,702.6308
<b>Total</b>	<b>2.6047</b>	<b>19.6358</b>	<b>17.8521</b>	<b>0.0293</b>		<b>1.1187</b>	<b>1.1187</b>		<b>1.0783</b>	<b>1.0783</b>	<b>0.0000</b>	<b>2,690.8055</b>	<b>2,690.8055</b>	<b>0.4730</b>		<b>2,702.6308</b>

**Mitigated Construction Off-Site**

	ROG	NOx	CO	SO2	Fugitive PM10	Exhaust PM10	PM10 Total	Fugitive PM2.5	Exhaust PM2.5	PM2.5 Total	Bio- CO2	NBio- CO2	Total CO2	CH4	N2O	CO2e
Category	lb/day										lb/day					
Hauling	0.0000	0.0000	0.0000	0.0000	0.0000	0.0000	0.0000	0.0000	0.0000	0.0000		0.0000	0.0000	0.0000		0.0000
Vendor	0.0000	0.0000	0.0000	0.0000	0.0000	0.0000	0.0000	0.0000	0.0000	0.0000		0.0000	0.0000	0.0000		0.0000
Worker	0.0000	0.0000	0.0000	0.0000	0.0000	0.0000	0.0000	0.0000	0.0000	0.0000		0.0000	0.0000	0.0000		0.0000
<b>Total</b>	<b>0.0000</b>	<b>0.0000</b>	<b>0.0000</b>	<b>0.0000</b>	<b>0.0000</b>	<b>0.0000</b>	<b>0.0000</b>	<b>0.0000</b>	<b>0.0000</b>	<b>0.0000</b>		<b>0.0000</b>	<b>0.0000</b>	<b>0.0000</b>		<b>0.0000</b>

TVMWD Pipeline - Los Angeles-South Coast County, Summer

**3.3 Paving - 2020**

**Unmitigated Construction On-Site**

	ROG	NOx	CO	SO2	Fugitive PM10	Exhaust PM10	PM10 Total	Fugitive PM2.5	Exhaust PM2.5	PM2.5 Total	Bio- CO2	NBio- CO2	Total CO2	CH4	N2O	CO2e
Category	lb/day										lb/day					
Off-Road	0.8402	8.4514	8.8758	0.0135		0.4695	0.4695		0.4328	0.4328		1,296.946 1	1,296.946 1	0.4111		1,307.224 6
Paving	0.5240					0.0000	0.0000		0.0000	0.0000			0.0000			0.0000
<b>Total</b>	<b>1.3642</b>	<b>8.4514</b>	<b>8.8758</b>	<b>0.0135</b>		<b>0.4695</b>	<b>0.4695</b>		<b>0.4328</b>	<b>0.4328</b>		<b>1,296.946 1</b>	<b>1,296.946 1</b>	<b>0.4111</b>		<b>1,307.224 6</b>

**Unmitigated Construction Off-Site**

	ROG	NOx	CO	SO2	Fugitive PM10	Exhaust PM10	PM10 Total	Fugitive PM2.5	Exhaust PM2.5	PM2.5 Total	Bio- CO2	NBio- CO2	Total CO2	CH4	N2O	CO2e
Category	lb/day										lb/day					
Hauling	0.0000	0.0000	0.0000	0.0000	0.0000	0.0000	0.0000	0.0000	0.0000	0.0000		0.0000	0.0000	0.0000		0.0000
Vendor	0.0000	0.0000	0.0000	0.0000	0.0000	0.0000	0.0000	0.0000	0.0000	0.0000		0.0000	0.0000	0.0000		0.0000
Worker	0.0598	0.0426	0.5692	1.5400e-003	0.1453	1.2100e-003	0.1465	0.0385	1.1200e-003	0.0397		152.8947	152.8947	4.8200e-003		153.0152
<b>Total</b>	<b>0.0598</b>	<b>0.0426</b>	<b>0.5692</b>	<b>1.5400e-003</b>	<b>0.1453</b>	<b>1.2100e-003</b>	<b>0.1465</b>	<b>0.0385</b>	<b>1.1200e-003</b>	<b>0.0397</b>		<b>152.8947</b>	<b>152.8947</b>	<b>4.8200e-003</b>		<b>153.0152</b>

TVMWD Pipeline - Los Angeles-South Coast County, Summer

**3.3 Paving - 2020**

**Mitigated Construction On-Site**

	ROG	NOx	CO	SO2	Fugitive PM10	Exhaust PM10	PM10 Total	Fugitive PM2.5	Exhaust PM2.5	PM2.5 Total	Bio- CO2	NBio- CO2	Total CO2	CH4	N2O	CO2e
Category	lb/day										lb/day					
Off-Road	0.8402	8.4514	8.8758	0.0135		0.4695	0.4695		0.4328	0.4328	0.0000	1,296.9461	1,296.9461	0.4111		1,307.2246
Paving	0.5240					0.0000	0.0000		0.0000	0.0000			0.0000			0.0000
<b>Total</b>	<b>1.3642</b>	<b>8.4514</b>	<b>8.8758</b>	<b>0.0135</b>		<b>0.4695</b>	<b>0.4695</b>		<b>0.4328</b>	<b>0.4328</b>	<b>0.0000</b>	<b>1,296.9461</b>	<b>1,296.9461</b>	<b>0.4111</b>		<b>1,307.2246</b>

**Mitigated Construction Off-Site**

	ROG	NOx	CO	SO2	Fugitive PM10	Exhaust PM10	PM10 Total	Fugitive PM2.5	Exhaust PM2.5	PM2.5 Total	Bio- CO2	NBio- CO2	Total CO2	CH4	N2O	CO2e
Category	lb/day										lb/day					
Hauling	0.0000	0.0000	0.0000	0.0000	0.0000	0.0000	0.0000	0.0000	0.0000	0.0000		0.0000	0.0000	0.0000		0.0000
Vendor	0.0000	0.0000	0.0000	0.0000	0.0000	0.0000	0.0000	0.0000	0.0000	0.0000		0.0000	0.0000	0.0000		0.0000
Worker	0.0598	0.0426	0.5692	1.5400e-003	0.1453	1.2100e-003	0.1465	0.0385	1.1200e-003	0.0397		152.8947	152.8947	4.8200e-003		153.0152
<b>Total</b>	<b>0.0598</b>	<b>0.0426</b>	<b>0.5692</b>	<b>1.5400e-003</b>	<b>0.1453</b>	<b>1.2100e-003</b>	<b>0.1465</b>	<b>0.0385</b>	<b>1.1200e-003</b>	<b>0.0397</b>		<b>152.8947</b>	<b>152.8947</b>	<b>4.8200e-003</b>		<b>153.0152</b>

**4.0 Operational Detail - Mobile**

TVMWD Pipeline - Los Angeles-South Coast County, Summer

4.1 Mitigation Measures Mobile

	ROG	NOx	CO	SO2	Fugitive PM10	Exhaust PM10	PM10 Total	Fugitive PM2.5	Exhaust PM2.5	PM2.5 Total	Bio- CO2	NBio- CO2	Total CO2	CH4	N2O	CO2e
Category	lb/day										lb/day					
Mitigated	0.0000	0.0000	0.0000	0.0000	0.0000	0.0000	0.0000	0.0000	0.0000	0.0000		0.0000	0.0000	0.0000		0.0000
Unmitigated	0.0000	0.0000	0.0000	0.0000	0.0000	0.0000	0.0000	0.0000	0.0000	0.0000		0.0000	0.0000	0.0000		0.0000

4.2 Trip Summary Information

Land Use	Average Daily Trip Rate			Unmitigated	Mitigated
	Weekday	Saturday	Sunday	Annual VMT	Annual VMT
Other Asphalt Surfaces	0.00	0.00	0.00		
Total	0.00	0.00	0.00		

4.3 Trip Type Information

Land Use	Miles			Trip %			Trip Purpose %		
	H-W or C-W	H-S or C-C	H-O or C-NW	H-W or C-W	H-S or C-C	H-O or C-NW	Primary	Diverted	Pass-by
Other Asphalt Surfaces	16.60	8.40	6.90	0.00	0.00	0.00	0	0	0

4.4 Fleet Mix

Land Use	LDA	LDT1	LDT2	MDV	LHD1	LHD2	MHD	HHD	OBUS	UBUS	MCY	SBUS	MH
Other Asphalt Surfaces	0.546501	0.044961	0.204016	0.120355	0.015740	0.006196	0.020131	0.030678	0.002515	0.002201	0.005142	0.000687	0.000876

TVMWD Pipeline - Los Angeles-South Coast County, Summer

**5.0 Energy Detail**

---

Historical Energy Use: N

**5.1 Mitigation Measures Energy**

---

	ROG	NOx	CO	SO2	Fugitive PM10	Exhaust PM10	PM10 Total	Fugitive PM2.5	Exhaust PM2.5	PM2.5 Total	Bio- CO2	NBio- CO2	Total CO2	CH4	N2O	CO2e
Category	lb/day										lb/day					
NaturalGas Mitigated	0.0000	0.0000	0.0000	0.0000		0.0000	0.0000		0.0000	0.0000		0.0000	0.0000	0.0000	0.0000	0.0000
NaturalGas Unmitigated	0.0000	0.0000	0.0000	0.0000		0.0000	0.0000		0.0000	0.0000		0.0000	0.0000	0.0000	0.0000	0.0000



TVMWD Pipeline - Los Angeles-South Coast County, Summer

**5.2 Energy by Land Use - Natural Gas**

**Unmitigated**

	Natural Gas Use	ROG	NOx	CO	SO2	Fugitive PM10	Exhaust PM10	PM10 Total	Fugitive PM2.5	Exhaust PM2.5	PM2.5 Total	Bio- CO2	NBio- CO2	Total CO2	CH4	N2O	CO2e
Land Use	kBTU/yr	lb/day										lb/day					
Other Asphalt Surfaces	0	0.0000	0.0000	0.0000	0.0000		0.0000	0.0000		0.0000	0.0000		0.0000	0.0000	0.0000	0.0000	0.0000
<b>Total</b>		<b>0.0000</b>	<b>0.0000</b>	<b>0.0000</b>	<b>0.0000</b>		<b>0.0000</b>	<b>0.0000</b>		<b>0.0000</b>	<b>0.0000</b>		<b>0.0000</b>	<b>0.0000</b>	<b>0.0000</b>	<b>0.0000</b>	<b>0.0000</b>

**Mitigated**

	Natural Gas Use	ROG	NOx	CO	SO2	Fugitive PM10	Exhaust PM10	PM10 Total	Fugitive PM2.5	Exhaust PM2.5	PM2.5 Total	Bio- CO2	NBio- CO2	Total CO2	CH4	N2O	CO2e
Land Use	kBTU/yr	lb/day										lb/day					
Other Asphalt Surfaces	0	0.0000	0.0000	0.0000	0.0000		0.0000	0.0000		0.0000	0.0000		0.0000	0.0000	0.0000	0.0000	0.0000
<b>Total</b>		<b>0.0000</b>	<b>0.0000</b>	<b>0.0000</b>	<b>0.0000</b>		<b>0.0000</b>	<b>0.0000</b>		<b>0.0000</b>	<b>0.0000</b>		<b>0.0000</b>	<b>0.0000</b>	<b>0.0000</b>	<b>0.0000</b>	<b>0.0000</b>

**6.0 Area Detail**

**6.1 Mitigation Measures Area**

TVMWD Pipeline - Los Angeles-South Coast County, Summer

	ROG	NOx	CO	SO2	Fugitive PM10	Exhaust PM10	PM10 Total	Fugitive PM2.5	Exhaust PM2.5	PM2.5 Total	Bio- CO2	NBio- CO2	Total CO2	CH4	N2O	CO2e
Category	lb/day										lb/day					
Mitigated	4.4000e-004	0.0000	1.0000e-004	0.0000		0.0000	0.0000		0.0000	0.0000		2.2000e-004	2.2000e-004	0.0000		2.3000e-004
Unmitigated	4.4000e-004	0.0000	1.0000e-004	0.0000		0.0000	0.0000		0.0000	0.0000		2.2000e-004	2.2000e-004	0.0000		2.3000e-004

6.2 Area by SubCategory

Unmitigated

	ROG	NOx	CO	SO2	Fugitive PM10	Exhaust PM10	PM10 Total	Fugitive PM2.5	Exhaust PM2.5	PM2.5 Total	Bio- CO2	NBio- CO2	Total CO2	CH4	N2O	CO2e
SubCategory	lb/day										lb/day					
Architectural Coating	8.0000e-005					0.0000	0.0000		0.0000	0.0000			0.0000			0.0000
Consumer Products	3.5000e-004					0.0000	0.0000		0.0000	0.0000			0.0000			0.0000
Landscaping	1.0000e-005	0.0000	1.0000e-004	0.0000		0.0000	0.0000		0.0000	0.0000		2.2000e-004	2.2000e-004	0.0000		2.3000e-004
<b>Total</b>	<b>4.4000e-004</b>	<b>0.0000</b>	<b>1.0000e-004</b>	<b>0.0000</b>		<b>0.0000</b>	<b>0.0000</b>		<b>0.0000</b>	<b>0.0000</b>		<b>2.2000e-004</b>	<b>2.2000e-004</b>	<b>0.0000</b>		<b>2.3000e-004</b>

TVMWD Pipeline - Los Angeles-South Coast County, Summer

**6.2 Area by SubCategory**

**Mitigated**

	ROG	NOx	CO	SO2	Fugitive PM10	Exhaust PM10	PM10 Total	Fugitive PM2.5	Exhaust PM2.5	PM2.5 Total	Bio- CO2	NBio- CO2	Total CO2	CH4	N2O	CO2e
SubCategory	lb/day										lb/day					
Architectural Coating	8.0000e-005					0.0000	0.0000		0.0000	0.0000			0.0000			0.0000
Consumer Products	3.5000e-004					0.0000	0.0000		0.0000	0.0000			0.0000			0.0000
Landscaping	1.0000e-005	0.0000	1.0000e-004	0.0000		0.0000	0.0000		0.0000	0.0000		2.2000e-004	2.2000e-004	0.0000		2.3000e-004
<b>Total</b>	<b>4.4000e-004</b>	<b>0.0000</b>	<b>1.0000e-004</b>	<b>0.0000</b>		<b>0.0000</b>	<b>0.0000</b>		<b>0.0000</b>	<b>0.0000</b>		<b>2.2000e-004</b>	<b>2.2000e-004</b>	<b>0.0000</b>		<b>2.3000e-004</b>

**7.0 Water Detail**

**7.1 Mitigation Measures Water**

**8.0 Waste Detail**

**8.1 Mitigation Measures Waste**

**9.0 Operational Offroad**

Equipment Type	Number	Hours/Day	Days/Year	Horse Power	Load Factor	Fuel Type
----------------	--------	-----------	-----------	-------------	-------------	-----------

**10.0 Stationary Equipment**

**Fire Pumps and Emergency Generators**

TVMWD Pipeline - Los Angeles-South Coast County, Summer

Equipment Type	Number	Hours/Day	Hours/Year	Horse Power	Load Factor	Fuel Type
----------------	--------	-----------	------------	-------------	-------------	-----------

**Boilers**

Equipment Type	Number	Heat Input/Day	Heat Input/Year	Boiler Rating	Fuel Type
----------------	--------	----------------	-----------------	---------------	-----------

**User Defined Equipment**

Equipment Type	Number
----------------	--------

**11.0 Vegetation**

---

TVMWD Pipeline - Los Angeles-South Coast County, Winter

**TVMWD Pipeline**  
**Los Angeles-South Coast County, Winter**

**1.0 Project Characteristics**

---

**1.1 Land Usage**

Land Uses	Size	Metric	Lot Acreage	Floor Surface Area	Population
Other Asphalt Surfaces	1.00	1000sqft	1.00	1,000.00	0

**1.2 Other Project Characteristics**

<b>Urbanization</b>	Urban	<b>Wind Speed (m/s)</b>	2.2	<b>Precipitation Freq (Days)</b>	33
<b>Climate Zone</b>	10			<b>Operational Year</b>	2022
<b>Utility Company</b>	Southern California Edison				
<b>CO2 Intensity (lb/MWhr)</b>	702.44	<b>CH4 Intensity (lb/MWhr)</b>	0.029	<b>N2O Intensity (lb/MWhr)</b>	0.006

**1.3 User Entered Comments & Non-Default Data**

- Project Characteristics -
- Land Use - Per Applicant
- Construction Phase - Per Contractor
- Off-road Equipment - per contractor
- Off-road Equipment -
- Construction Off-road Equipment Mitigation -

TVMWD Pipeline - Los Angeles-South Coast County, Winter

Table Name	Column Name	Default Value	New Value
tblLandUse	LotAcreage	0.02	1.00
tblOffRoadEquipment	HorsePower	81.00	84.00
tblOffRoadEquipment	HorsePower	172.00	89.00
tblOffRoadEquipment	HorsePower	16.00	46.00
tblOffRoadEquipment	LoadFactor	0.73	0.74
tblOffRoadEquipment	LoadFactor	0.42	0.20
tblOffRoadEquipment	LoadFactor	0.38	0.45
tblOffRoadEquipment	OffRoadEquipmentType	Generator Sets	Concrete/Industrial Saws
tblOffRoadEquipment	OffRoadEquipmentType	Forklifts	Other Construction Equipment
tblOffRoadEquipment	OffRoadEquipmentType	Welders	Dumpers/Tenders

**2.0 Emissions Summary**

---



TVMWD Pipeline - Los Angeles-South Coast County, Winter

**2.2 Overall Operational**

**Unmitigated Operational**

	ROG	NOx	CO	SO2	Fugitive PM10	Exhaust PM10	PM10 Total	Fugitive PM2.5	Exhaust PM2.5	PM2.5 Total	Bio- CO2	NBio- CO2	Total CO2	CH4	N2O	CO2e
Category	lb/day										lb/day					
Area	4.4000e-004	0.0000	1.0000e-004	0.0000		0.0000	0.0000		0.0000	0.0000		2.2000e-004	2.2000e-004	0.0000		2.3000e-004
Energy	0.0000	0.0000	0.0000	0.0000		0.0000	0.0000		0.0000	0.0000		0.0000	0.0000	0.0000	0.0000	0.0000
Mobile	0.0000	0.0000	0.0000	0.0000	0.0000	0.0000	0.0000	0.0000	0.0000	0.0000		0.0000	0.0000	0.0000		0.0000
<b>Total</b>	<b>4.4000e-004</b>	<b>0.0000</b>	<b>1.0000e-004</b>	<b>0.0000</b>	<b>0.0000</b>	<b>0.0000</b>	<b>0.0000</b>	<b>0.0000</b>	<b>0.0000</b>	<b>0.0000</b>		<b>2.2000e-004</b>	<b>2.2000e-004</b>	<b>0.0000</b>	<b>0.0000</b>	<b>2.3000e-004</b>

**Mitigated Operational**

	ROG	NOx	CO	SO2	Fugitive PM10	Exhaust PM10	PM10 Total	Fugitive PM2.5	Exhaust PM2.5	PM2.5 Total	Bio- CO2	NBio- CO2	Total CO2	CH4	N2O	CO2e
Category	lb/day										lb/day					
Area	4.4000e-004	0.0000	1.0000e-004	0.0000		0.0000	0.0000		0.0000	0.0000		2.2000e-004	2.2000e-004	0.0000		2.3000e-004
Energy	0.0000	0.0000	0.0000	0.0000		0.0000	0.0000		0.0000	0.0000		0.0000	0.0000	0.0000	0.0000	0.0000
Mobile	0.0000	0.0000	0.0000	0.0000	0.0000	0.0000	0.0000	0.0000	0.0000	0.0000		0.0000	0.0000	0.0000		0.0000
<b>Total</b>	<b>4.4000e-004</b>	<b>0.0000</b>	<b>1.0000e-004</b>	<b>0.0000</b>	<b>0.0000</b>	<b>0.0000</b>	<b>0.0000</b>	<b>0.0000</b>	<b>0.0000</b>	<b>0.0000</b>		<b>2.2000e-004</b>	<b>2.2000e-004</b>	<b>0.0000</b>	<b>0.0000</b>	<b>2.3000e-004</b>



TVMWD Pipeline - Los Angeles-South Coast County, Winter

	ROG	NOx	CO	SO2	Fugitive PM10	Exhaust PM10	PM10 Total	Fugitive PM2.5	Exhaust PM2.5	PM2.5 Total	Bio- CO2	NBio-CO2	Total CO2	CH4	N2O	CO2e
Percent Reduction	0.00	0.00	0.00	0.00	0.00	0.00	0.00	0.00	0.00	0.00	0.00	0.00	0.00	0.00	0.00	0.00

**3.0 Construction Detail**

**Construction Phase**

Phase Number	Phase Name	Phase Type	Start Date	End Date	Num Days Week	Num Days	Phase Description
1	Building Construction	Building Construction	3/1/2020	7/17/2020	5	100	
2	Paving	Paving	7/18/2020	7/24/2020	5	5	

**Acres of Grading (Site Preparation Phase): 0**

**Acres of Grading (Grading Phase): 0**

**Acres of Paving: 1**

**Residential Indoor: 0; Residential Outdoor: 0; Non-Residential Indoor: 0; Non-Residential Outdoor: 0; Striped Parking Area: 0 (Architectural Coating – sqft)**

**OffRoad Equipment**

TVMWD Pipeline - Los Angeles-South Coast County, Winter

Phase Name	Offroad Equipment Type	Amount	Usage Hours	Horse Power	Load Factor
Building Construction	Forklifts	1	6.00	89	0.20
Paving	Cement and Mortar Mixers	1	6.00	9	0.56
Building Construction	Generator Sets	1	8.00	84	0.74
Building Construction	Concrete/Industrial Saws	1	6.00	84	0.74
Building Construction	Cranes	1	6.00	231	0.29
Building Construction	Other Construction Equipment	2	6.00	89	0.20
Building Construction	Welders	3	8.00	46	0.45
Paving	Pavers	1	6.00	130	0.42
Paving	Rollers	1	7.00	80	0.38
Building Construction	Tractors/Loaders/Backhoes	1	6.00	97	0.37
Paving	Tractors/Loaders/Backhoes	1	8.00	97	0.37
Paving	Paving Equipment	1	8.00	132	0.36
Building Construction	Dumpers/Tenders	1	6.00	46	0.45

**Trips and VMT**

Phase Name	Offroad Equipment Count	Worker Trip Number	Vendor Trip Number	Hauling Trip Number	Worker Trip Length	Vendor Trip Length	Hauling Trip Length	Worker Vehicle Class	Vendor Vehicle Class	Hauling Vehicle Class
Building Construction	11	0.00	0.00	0.00	14.70	6.90	20.00	LD_Mix	HDT_Mix	HHDT
Paving	5	13.00	0.00	0.00	14.70	6.90	20.00	LD_Mix	HDT_Mix	HHDT

**3.1 Mitigation Measures Construction**

Water Exposed Area

TVMWD Pipeline - Los Angeles-South Coast County, Winter

**3.2 Building Construction - 2020**

**Unmitigated Construction On-Site**

	ROG	NOx	CO	SO2	Fugitive PM10	Exhaust PM10	PM10 Total	Fugitive PM2.5	Exhaust PM2.5	PM2.5 Total	Bio- CO2	NBio- CO2	Total CO2	CH4	N2O	CO2e
Category	lb/day										lb/day					
Off-Road	2.6047	19.6358	17.8521	0.0293		1.1187	1.1187		1.0783	1.0783		2,690.8055	2,690.8055	0.4730		2,702.6308
<b>Total</b>	<b>2.6047</b>	<b>19.6358</b>	<b>17.8521</b>	<b>0.0293</b>		<b>1.1187</b>	<b>1.1187</b>		<b>1.0783</b>	<b>1.0783</b>		<b>2,690.8055</b>	<b>2,690.8055</b>	<b>0.4730</b>		<b>2,702.6308</b>

**Unmitigated Construction Off-Site**

	ROG	NOx	CO	SO2	Fugitive PM10	Exhaust PM10	PM10 Total	Fugitive PM2.5	Exhaust PM2.5	PM2.5 Total	Bio- CO2	NBio- CO2	Total CO2	CH4	N2O	CO2e
Category	lb/day										lb/day					
Hauling	0.0000	0.0000	0.0000	0.0000	0.0000	0.0000	0.0000	0.0000	0.0000	0.0000		0.0000	0.0000	0.0000		0.0000
Vendor	0.0000	0.0000	0.0000	0.0000	0.0000	0.0000	0.0000	0.0000	0.0000	0.0000		0.0000	0.0000	0.0000		0.0000
Worker	0.0000	0.0000	0.0000	0.0000	0.0000	0.0000	0.0000	0.0000	0.0000	0.0000		0.0000	0.0000	0.0000		0.0000
<b>Total</b>	<b>0.0000</b>	<b>0.0000</b>	<b>0.0000</b>	<b>0.0000</b>	<b>0.0000</b>	<b>0.0000</b>	<b>0.0000</b>	<b>0.0000</b>	<b>0.0000</b>	<b>0.0000</b>		<b>0.0000</b>	<b>0.0000</b>	<b>0.0000</b>		<b>0.0000</b>

TVMWD Pipeline - Los Angeles-South Coast County, Winter

**3.2 Building Construction - 2020**

**Mitigated Construction On-Site**

	ROG	NOx	CO	SO2	Fugitive PM10	Exhaust PM10	PM10 Total	Fugitive PM2.5	Exhaust PM2.5	PM2.5 Total	Bio- CO2	NBio- CO2	Total CO2	CH4	N2O	CO2e
Category	lb/day										lb/day					
Off-Road	2.6047	19.6358	17.8521	0.0293		1.1187	1.1187		1.0783	1.0783	0.0000	2,690.8055	2,690.8055	0.4730		2,702.6308
<b>Total</b>	<b>2.6047</b>	<b>19.6358</b>	<b>17.8521</b>	<b>0.0293</b>		<b>1.1187</b>	<b>1.1187</b>		<b>1.0783</b>	<b>1.0783</b>	<b>0.0000</b>	<b>2,690.8055</b>	<b>2,690.8055</b>	<b>0.4730</b>		<b>2,702.6308</b>

**Mitigated Construction Off-Site**

	ROG	NOx	CO	SO2	Fugitive PM10	Exhaust PM10	PM10 Total	Fugitive PM2.5	Exhaust PM2.5	PM2.5 Total	Bio- CO2	NBio- CO2	Total CO2	CH4	N2O	CO2e
Category	lb/day										lb/day					
Hauling	0.0000	0.0000	0.0000	0.0000	0.0000	0.0000	0.0000	0.0000	0.0000	0.0000		0.0000	0.0000	0.0000		0.0000
Vendor	0.0000	0.0000	0.0000	0.0000	0.0000	0.0000	0.0000	0.0000	0.0000	0.0000		0.0000	0.0000	0.0000		0.0000
Worker	0.0000	0.0000	0.0000	0.0000	0.0000	0.0000	0.0000	0.0000	0.0000	0.0000		0.0000	0.0000	0.0000		0.0000
<b>Total</b>	<b>0.0000</b>	<b>0.0000</b>	<b>0.0000</b>	<b>0.0000</b>	<b>0.0000</b>	<b>0.0000</b>	<b>0.0000</b>	<b>0.0000</b>	<b>0.0000</b>	<b>0.0000</b>		<b>0.0000</b>	<b>0.0000</b>	<b>0.0000</b>		<b>0.0000</b>

TVMWD Pipeline - Los Angeles-South Coast County, Winter

**3.3 Paving - 2020**

**Unmitigated Construction On-Site**

	ROG	NOx	CO	SO2	Fugitive PM10	Exhaust PM10	PM10 Total	Fugitive PM2.5	Exhaust PM2.5	PM2.5 Total	Bio- CO2	NBio- CO2	Total CO2	CH4	N2O	CO2e
Category	lb/day										lb/day					
Off-Road	0.8402	8.4514	8.8758	0.0135		0.4695	0.4695		0.4328	0.4328		1,296.9461	1,296.9461	0.4111		1,307.2246
Paving	0.5240					0.0000	0.0000		0.0000	0.0000			0.0000			0.0000
<b>Total</b>	<b>1.3642</b>	<b>8.4514</b>	<b>8.8758</b>	<b>0.0135</b>		<b>0.4695</b>	<b>0.4695</b>		<b>0.4328</b>	<b>0.4328</b>		<b>1,296.9461</b>	<b>1,296.9461</b>	<b>0.4111</b>		<b>1,307.2246</b>

**Unmitigated Construction Off-Site**

	ROG	NOx	CO	SO2	Fugitive PM10	Exhaust PM10	PM10 Total	Fugitive PM2.5	Exhaust PM2.5	PM2.5 Total	Bio- CO2	NBio- CO2	Total CO2	CH4	N2O	CO2e
Category	lb/day										lb/day					
Hauling	0.0000	0.0000	0.0000	0.0000	0.0000	0.0000	0.0000	0.0000	0.0000	0.0000		0.0000	0.0000	0.0000		0.0000
Vendor	0.0000	0.0000	0.0000	0.0000	0.0000	0.0000	0.0000	0.0000	0.0000	0.0000		0.0000	0.0000	0.0000		0.0000
Worker	0.0664	0.0471	0.5213	1.4500e-003	0.1453	1.2100e-003	0.1465	0.0385	1.1200e-003	0.0397		143.9647	143.9647	4.5400e-003		144.0781
<b>Total</b>	<b>0.0664</b>	<b>0.0471</b>	<b>0.5213</b>	<b>1.4500e-003</b>	<b>0.1453</b>	<b>1.2100e-003</b>	<b>0.1465</b>	<b>0.0385</b>	<b>1.1200e-003</b>	<b>0.0397</b>		<b>143.9647</b>	<b>143.9647</b>	<b>4.5400e-003</b>		<b>144.0781</b>

TVMWD Pipeline - Los Angeles-South Coast County, Winter

**3.3 Paving - 2020**

**Mitigated Construction On-Site**

	ROG	NOx	CO	SO2	Fugitive PM10	Exhaust PM10	PM10 Total	Fugitive PM2.5	Exhaust PM2.5	PM2.5 Total	Bio- CO2	NBio- CO2	Total CO2	CH4	N2O	CO2e
Category	lb/day										lb/day					
Off-Road	0.8402	8.4514	8.8758	0.0135		0.4695	0.4695		0.4328	0.4328	0.0000	1,296.9461	1,296.9461	0.4111		1,307.2246
Paving	0.5240					0.0000	0.0000		0.0000	0.0000			0.0000			0.0000
<b>Total</b>	<b>1.3642</b>	<b>8.4514</b>	<b>8.8758</b>	<b>0.0135</b>		<b>0.4695</b>	<b>0.4695</b>		<b>0.4328</b>	<b>0.4328</b>	<b>0.0000</b>	<b>1,296.9461</b>	<b>1,296.9461</b>	<b>0.4111</b>		<b>1,307.2246</b>

**Mitigated Construction Off-Site**

	ROG	NOx	CO	SO2	Fugitive PM10	Exhaust PM10	PM10 Total	Fugitive PM2.5	Exhaust PM2.5	PM2.5 Total	Bio- CO2	NBio- CO2	Total CO2	CH4	N2O	CO2e
Category	lb/day										lb/day					
Hauling	0.0000	0.0000	0.0000	0.0000	0.0000	0.0000	0.0000	0.0000	0.0000	0.0000		0.0000	0.0000	0.0000		0.0000
Vendor	0.0000	0.0000	0.0000	0.0000	0.0000	0.0000	0.0000	0.0000	0.0000	0.0000		0.0000	0.0000	0.0000		0.0000
Worker	0.0664	0.0471	0.5213	1.4500e-003	0.1453	1.2100e-003	0.1465	0.0385	1.1200e-003	0.0397		143.9647	143.9647	4.5400e-003		144.0781
<b>Total</b>	<b>0.0664</b>	<b>0.0471</b>	<b>0.5213</b>	<b>1.4500e-003</b>	<b>0.1453</b>	<b>1.2100e-003</b>	<b>0.1465</b>	<b>0.0385</b>	<b>1.1200e-003</b>	<b>0.0397</b>		<b>143.9647</b>	<b>143.9647</b>	<b>4.5400e-003</b>		<b>144.0781</b>

**4.0 Operational Detail - Mobile**

TVMWD Pipeline - Los Angeles-South Coast County, Winter

4.1 Mitigation Measures Mobile

	ROG	NOx	CO	SO2	Fugitive PM10	Exhaust PM10	PM10 Total	Fugitive PM2.5	Exhaust PM2.5	PM2.5 Total	Bio- CO2	NBio- CO2	Total CO2	CH4	N2O	CO2e
Category	lb/day										lb/day					
Mitigated	0.0000	0.0000	0.0000	0.0000	0.0000	0.0000	0.0000	0.0000	0.0000	0.0000		0.0000	0.0000	0.0000		0.0000
Unmitigated	0.0000	0.0000	0.0000	0.0000	0.0000	0.0000	0.0000	0.0000	0.0000	0.0000		0.0000	0.0000	0.0000		0.0000

4.2 Trip Summary Information

Land Use	Average Daily Trip Rate			Unmitigated	Mitigated
	Weekday	Saturday	Sunday	Annual VMT	Annual VMT
Other Asphalt Surfaces	0.00	0.00	0.00		
Total	0.00	0.00	0.00		

4.3 Trip Type Information

Land Use	Miles			Trip %			Trip Purpose %		
	H-W or C-W	H-S or C-C	H-O or C-NW	H-W or C-W	H-S or C-C	H-O or C-NW	Primary	Diverted	Pass-by
Other Asphalt Surfaces	16.60	8.40	6.90	0.00	0.00	0.00	0	0	0

4.4 Fleet Mix

Land Use	LDA	LDT1	LDT2	MDV	LHD1	LHD2	MHD	HHD	OBUS	UBUS	MCY	SBUS	MH
Other Asphalt Surfaces	0.546501	0.044961	0.204016	0.120355	0.015740	0.006196	0.020131	0.030678	0.002515	0.002201	0.005142	0.000687	0.000876

TVMWD Pipeline - Los Angeles-South Coast County, Winter

**5.0 Energy Detail**

Historical Energy Use: N

**5.1 Mitigation Measures Energy**

	ROG	NOx	CO	SO2	Fugitive PM10	Exhaust PM10	PM10 Total	Fugitive PM2.5	Exhaust PM2.5	PM2.5 Total	Bio- CO2	NBio- CO2	Total CO2	CH4	N2O	CO2e
Category	lb/day										lb/day					
NaturalGas Mitigated	0.0000	0.0000	0.0000	0.0000		0.0000	0.0000		0.0000	0.0000		0.0000	0.0000	0.0000	0.0000	0.0000
NaturalGas Unmitigated	0.0000	0.0000	0.0000	0.0000		0.0000	0.0000		0.0000	0.0000		0.0000	0.0000	0.0000	0.0000	0.0000



TVMWD Pipeline - Los Angeles-South Coast County, Winter

**5.2 Energy by Land Use - NaturalGas**

**Unmitigated**

	NaturalGas Use	ROG	NOx	CO	SO2	Fugitive PM10	Exhaust PM10	PM10 Total	Fugitive PM2.5	Exhaust PM2.5	PM2.5 Total	Bio- CO2	NBio- CO2	Total CO2	CH4	N2O	CO2e
Land Use	kBTU/yr	lb/day										lb/day					
Other Asphalt Surfaces	0	0.0000	0.0000	0.0000	0.0000		0.0000	0.0000		0.0000	0.0000		0.0000	0.0000	0.0000	0.0000	0.0000
<b>Total</b>		<b>0.0000</b>	<b>0.0000</b>	<b>0.0000</b>	<b>0.0000</b>		<b>0.0000</b>	<b>0.0000</b>		<b>0.0000</b>	<b>0.0000</b>		<b>0.0000</b>	<b>0.0000</b>	<b>0.0000</b>	<b>0.0000</b>	<b>0.0000</b>

**Mitigated**

	NaturalGas Use	ROG	NOx	CO	SO2	Fugitive PM10	Exhaust PM10	PM10 Total	Fugitive PM2.5	Exhaust PM2.5	PM2.5 Total	Bio- CO2	NBio- CO2	Total CO2	CH4	N2O	CO2e
Land Use	kBTU/yr	lb/day										lb/day					
Other Asphalt Surfaces	0	0.0000	0.0000	0.0000	0.0000		0.0000	0.0000		0.0000	0.0000		0.0000	0.0000	0.0000	0.0000	0.0000
<b>Total</b>		<b>0.0000</b>	<b>0.0000</b>	<b>0.0000</b>	<b>0.0000</b>		<b>0.0000</b>	<b>0.0000</b>		<b>0.0000</b>	<b>0.0000</b>		<b>0.0000</b>	<b>0.0000</b>	<b>0.0000</b>	<b>0.0000</b>	<b>0.0000</b>

**6.0 Area Detail**

**6.1 Mitigation Measures Area**

TVMWD Pipeline - Los Angeles-South Coast County, Winter

	ROG	NOx	CO	SO2	Fugitive PM10	Exhaust PM10	PM10 Total	Fugitive PM2.5	Exhaust PM2.5	PM2.5 Total	Bio- CO2	NBio- CO2	Total CO2	CH4	N2O	CO2e
Category	lb/day										lb/day					
Mitigated	4.4000e-004	0.0000	1.0000e-004	0.0000		0.0000	0.0000		0.0000	0.0000		2.2000e-004	2.2000e-004	0.0000		2.3000e-004
Unmitigated	4.4000e-004	0.0000	1.0000e-004	0.0000		0.0000	0.0000		0.0000	0.0000		2.2000e-004	2.2000e-004	0.0000		2.3000e-004

6.2 Area by SubCategory

Unmitigated

	ROG	NOx	CO	SO2	Fugitive PM10	Exhaust PM10	PM10 Total	Fugitive PM2.5	Exhaust PM2.5	PM2.5 Total	Bio- CO2	NBio- CO2	Total CO2	CH4	N2O	CO2e
SubCategory	lb/day										lb/day					
Architectural Coating	8.0000e-005					0.0000	0.0000		0.0000	0.0000			0.0000			0.0000
Consumer Products	3.5000e-004					0.0000	0.0000		0.0000	0.0000			0.0000			0.0000
Landscaping	1.0000e-005	0.0000	1.0000e-004	0.0000		0.0000	0.0000		0.0000	0.0000		2.2000e-004	2.2000e-004	0.0000		2.3000e-004
<b>Total</b>	<b>4.4000e-004</b>	<b>0.0000</b>	<b>1.0000e-004</b>	<b>0.0000</b>		<b>0.0000</b>	<b>0.0000</b>		<b>0.0000</b>	<b>0.0000</b>		<b>2.2000e-004</b>	<b>2.2000e-004</b>	<b>0.0000</b>		<b>2.3000e-004</b>

TVMWD Pipeline - Los Angeles-South Coast County, Winter

**6.2 Area by SubCategory**

**Mitigated**

	ROG	NOx	CO	SO2	Fugitive PM10	Exhaust PM10	PM10 Total	Fugitive PM2.5	Exhaust PM2.5	PM2.5 Total	Bio- CO2	NBio- CO2	Total CO2	CH4	N2O	CO2e
SubCategory	lb/day										lb/day					
Architectural Coating	8.0000e-005					0.0000	0.0000		0.0000	0.0000			0.0000			0.0000
Consumer Products	3.5000e-004					0.0000	0.0000		0.0000	0.0000			0.0000			0.0000
Landscaping	1.0000e-005	0.0000	1.0000e-004	0.0000		0.0000	0.0000		0.0000	0.0000		2.2000e-004	2.2000e-004	0.0000		2.3000e-004
<b>Total</b>	<b>4.4000e-004</b>	<b>0.0000</b>	<b>1.0000e-004</b>	<b>0.0000</b>		<b>0.0000</b>	<b>0.0000</b>		<b>0.0000</b>	<b>0.0000</b>		<b>2.2000e-004</b>	<b>2.2000e-004</b>	<b>0.0000</b>		<b>2.3000e-004</b>

**7.0 Water Detail**

**7.1 Mitigation Measures Water**

**8.0 Waste Detail**

**8.1 Mitigation Measures Waste**

**9.0 Operational Offroad**

Equipment Type	Number	Hours/Day	Days/Year	Horse Power	Load Factor	Fuel Type
----------------	--------	-----------	-----------	-------------	-------------	-----------

**10.0 Stationary Equipment**

**Fire Pumps and Emergency Generators**

TVMWD Pipeline - Los Angeles-South Coast County, Winter

Equipment Type	Number	Hours/Day	Hours/Year	Horse Power	Load Factor	Fuel Type
----------------	--------	-----------	------------	-------------	-------------	-----------

**Boilers**

Equipment Type	Number	Heat Input/Day	Heat Input/Year	Boiler Rating	Fuel Type
----------------	--------	----------------	-----------------	---------------	-----------

**User Defined Equipment**

Equipment Type	Number
----------------	--------

**11.0 Vegetation**

---

TVMWD Production Well - Los Angeles-South Coast County, Annual

**TVMWD Production Well**  
**Los Angeles-South Coast County, Annual**

**1.0 Project Characteristics**

**1.1 Land Usage**

Land Uses	Size	Metric	Lot Acreage	Floor Surface Area	Population
User Defined Industrial	1.00	User Defined Unit	0.10	500.00	0
Other Non-Asphalt Surfaces	5.00	1000sqft	0.11	5,000.00	0
Parking Lot	10.00	1000sqft	0.23	10,000.00	0

**1.2 Other Project Characteristics**

<b>Urbanization</b>	Urban	<b>Wind Speed (m/s)</b>	2.2	<b>Precipitation Freq (Days)</b>	33
<b>Climate Zone</b>	10			<b>Operational Year</b>	2022
<b>Utility Company</b>	Southern California Edison				
<b>CO2 Intensity (lb/MWhr)</b>	702.44	<b>CH4 Intensity (lb/MWhr)</b>	0.029	<b>N2O Intensity (lb/MWhr)</b>	0.006

**1.3 User Entered Comments & Non-Default Data**

TVMWD Production Well - Los Angeles-South Coast County, Annual

Project Characteristics -

Land Use - Site plan

Construction Phase - Per construction contractor

Off-road Equipment - Per contractor

Off-road Equipment - Per contractor

Off-road Equipment - Per contractor

Off-road Equipment - Per contractor

Off-road Equipment - Per contractor

Demolition -

Vehicle Trips - Per applicant

Construction Off-road Equipment Mitigation -

TVMWD Production Well - Los Angeles-South Coast County, Annual

Table Name	Column Name	Default Value	New Value
tblConstructionPhase	NumDays	100.00	58.00
tblLandUse	LandUseSquareFeet	0.00	500.00
tblLandUse	LotAcreage	0.00	0.10
tblOffRoadEquipment	HorsePower	132.00	172.00
tblOffRoadEquipment	LoadFactor	0.36	0.42
tblOffRoadEquipment	OffRoadEquipmentUnitAmount	4.00	1.00
tblOffRoadEquipment	OffRoadEquipmentUnitAmount	2.00	1.00
tblOffRoadEquipment	UsageHours	8.00	6.00
tblOffRoadEquipment	UsageHours	1.00	4.00
tblOffRoadEquipment	UsageHours	6.00	4.00
tblOffRoadEquipment	UsageHours	8.00	6.00
tblTripsAndVMT	WorkerTripNumber	13.00	10.00
tblTripsAndVMT	WorkerTripNumber	20.00	15.00
tblVehicleTrips	CC_TTP	0.00	100.00
tblVehicleTrips	PR_TP	0.00	100.00
tblVehicleTrips	WD_TR	0.00	0.43

**2.0 Emissions Summary**

---





TVMWD Production Well - Los Angeles-South Coast County, Annual

Quarter	Start Date	End Date	Maximum Unmitigated ROG + NOX (tons/quarter)	Maximum Mitigated ROG + NOX (tons/quarter)
1	11-1-2019	1-31-2020	1.2843	1.2843
2	2-1-2020	4-30-2020	0.1784	0.1784
		Highest	1.2843	1.2843

2.2 Overall Operational

Unmitigated Operational

	ROG	NOx	CO	SO2	Fugitive PM10	Exhaust PM10	PM10 Total	Fugitive PM2.5	Exhaust PM2.5	PM2.5 Total	Bio- CO2	NBio- CO2	Total CO2	CH4	N2O	CO2e
Category	tons/yr										MT/yr					
Area	3.2400e-003	0.0000	2.0000e-004	0.0000		0.0000	0.0000		0.0000	0.0000	0.0000	4.0000e-004	4.0000e-004	0.0000	0.0000	4.2000e-004
Energy	0.0000	0.0000	0.0000	0.0000		0.0000	0.0000		0.0000	0.0000	0.0000	1.1152	1.1152	5.0000e-005	1.0000e-005	1.1192
Mobile	9.0000e-005	4.7000e-004	1.2000e-003	0.0000	3.6000e-004	0.0000	3.6000e-004	1.0000e-004	0.0000	1.0000e-004	0.0000	0.4008	0.4008	2.0000e-005	0.0000	0.4013
Waste						0.0000	0.0000		0.0000	0.0000	0.0000	0.0000	0.0000	0.0000	0.0000	0.0000
Water						0.0000	0.0000		0.0000	0.0000	0.0000	0.0000	0.0000	0.0000	0.0000	0.0000
<b>Total</b>	<b>3.3300e-003</b>	<b>4.7000e-004</b>	<b>1.4000e-003</b>	<b>0.0000</b>	<b>3.6000e-004</b>	<b>0.0000</b>	<b>3.6000e-004</b>	<b>1.0000e-004</b>	<b>0.0000</b>	<b>1.0000e-004</b>	<b>0.0000</b>	<b>1.5163</b>	<b>1.5163</b>	<b>7.0000e-005</b>	<b>1.0000e-005</b>	<b>1.5209</b>

TVMWD Production Well - Los Angeles-South Coast County, Annual

**2.2 Overall Operational**

**Mitigated Operational**

	ROG	NOx	CO	SO2	Fugitive PM10	Exhaust PM10	PM10 Total	Fugitive PM2.5	Exhaust PM2.5	PM2.5 Total	Bio- CO2	NBio- CO2	Total CO2	CH4	N2O	CO2e
Category	tons/yr										MT/yr					
Area	3.2400e-003	0.0000	2.0000e-004	0.0000		0.0000	0.0000		0.0000	0.0000	0.0000	4.0000e-004	4.0000e-004	0.0000	0.0000	4.2000e-004
Energy	0.0000	0.0000	0.0000	0.0000		0.0000	0.0000		0.0000	0.0000	0.0000	1.1152	1.1152	5.0000e-005	1.0000e-005	1.1192
Mobile	9.0000e-005	4.7000e-004	1.2000e-003	0.0000	3.6000e-004	0.0000	3.6000e-004	1.0000e-004	0.0000	1.0000e-004	0.0000	0.4008	0.4008	2.0000e-005	0.0000	0.4013
Waste						0.0000	0.0000		0.0000	0.0000	0.0000	0.0000	0.0000	0.0000	0.0000	0.0000
Water						0.0000	0.0000		0.0000	0.0000	0.0000	0.0000	0.0000	0.0000	0.0000	0.0000
<b>Total</b>	<b>3.3300e-003</b>	<b>4.7000e-004</b>	<b>1.4000e-003</b>	<b>0.0000</b>	<b>3.6000e-004</b>	<b>0.0000</b>	<b>3.6000e-004</b>	<b>1.0000e-004</b>	<b>0.0000</b>	<b>1.0000e-004</b>	<b>0.0000</b>	<b>1.5163</b>	<b>1.5163</b>	<b>7.0000e-005</b>	<b>1.0000e-005</b>	<b>1.5209</b>

	ROG	NOx	CO	SO2	Fugitive PM10	Exhaust PM10	PM10 Total	Fugitive PM2.5	Exhaust PM2.5	PM2.5 Total	Bio- CO2	NBio- CO2	Total CO2	CH4	N2O	CO2e
Percent Reduction	0.00	0.00	0.00	0.00	0.00	0.00	0.00	0.00	0.00	0.00	0.00	0.00	0.00	0.00	0.00	0.00

**3.0 Construction Detail**

**Construction Phase**

TVMWD Production Well - Los Angeles-South Coast County, Annual

Phase Number	Phase Name	Phase Type	Start Date	End Date	Num Days Week	Num Days	Phase Description
1	Site Preparation	Site Preparation	11/15/2019	11/15/2019	5	1	
2	Grading	Grading	11/16/2019	11/19/2019	5	2	
3	Building Construction	Building Construction	11/20/2019	2/7/2020	5	58	
4	Paving	Paving	2/8/2020	2/14/2020	5	5	
5	Architectural Coating	Architectural Coating	2/15/2020	2/21/2020	5	5	

Acres of Grading (Site Preparation Phase): 0.38

Acres of Grading (Grading Phase): 0.5

Acres of Paving: 0.34

Residential Indoor: 0; Residential Outdoor: 0; Non-Residential Indoor: 750; Non-Residential Outdoor: 250; Striped Parking Area: 900 (Architectural Coating – sqft)

OffRoad Equipment

Phase Name	Offroad Equipment Type	Amount	Usage Hours	Horse Power	Load Factor
Site Preparation	Graders	1	6.00	187	0.41
Site Preparation	Other Material Handling Equipment	1	8.00	168	0.40
Site Preparation	Rubber Tired Dozers	1	4.00	247	0.40
Site Preparation	Tractors/Loaders/Backhoes	1	6.00	97	0.37
Grading	Concrete/Industrial Saws	1	8.00	81	0.73
Grading	Graders	1	4.00	187	0.41
Grading	Other Material Handling Equipment	1	4.00	168	0.40
Grading	Rubber Tired Dozers	1	4.00	247	0.40
Grading	Tractors/Loaders/Backhoes	1	4.00	97	0.37
Building Construction	Bore/Drill Rigs	1	24.00	221	0.50
Building Construction	Cranes	1	4.00	231	0.29

TVMWD Production Well - Los Angeles-South Coast County, Annual

Building Construction	Forklifts	2	6.00	89	0.20
Building Construction	Generator Sets	1	24.00	84	0.74
Building Construction	Other Construction Equipment	1	8.00	172	0.42
Building Construction	Rubber Tired Dozers	1	4.00	247	0.40
Building Construction	Tractors/Loaders/Backhoes	2	8.00	97	0.37
Building Construction	Welders	1	4.00	46	0.45
Paving	Cement and Mortar Mixers	1	6.00	9	0.56
Paving	Concrete/Industrial Saws	1	8.00	81	0.73
Paving	Dumpers/Tenders	1	4.00	16	0.38
Paving	Graders	1	8.00	187	0.41
Paving	Pavers	1	7.00	130	0.42
Paving	Paving Equipment	1	8.00	172	0.42
Paving	Rollers	1	7.00	80	0.38
Paving	Rubber Tired Dozers	0		247	0.40
Paving	Tractors/Loaders/Backhoes	1	7.00	97	0.37
Paving	Welders	0		46	0.45
Architectural Coating	Air Compressors	1	6.00	78	0.48

**Trips and VMT**

Phase Name	Offroad Equipment Count	Worker Trip Number	Vendor Trip Number	Hauling Trip Number	Worker Trip Length	Vendor Trip Length	Hauling Trip Length	Worker Vehicle Class	Vendor Vehicle Class	Hauling Vehicle Class
Site Preparation	4	10.00	0.00	0.00	14.70	6.90	20.00	LD_Mix	HDT_Mix	HHDT
Grading	5	10.00	0.00	0.00	14.70	6.90	20.00	LD_Mix	HDT_Mix	HHDT
Building Construction	10	7.00	3.00	0.00	14.70	6.90	20.00	LD_Mix	HDT_Mix	HHDT
Paving	8	15.00	0.00	0.00	14.70	6.90	20.00	LD_Mix	HDT_Mix	HHDT
Architectural Coating	1	1.00	0.00	0.00	14.70	6.90	20.00	LD_Mix	HDT_Mix	HHDT

TVMWD Production Well - Los Angeles-South Coast County, Annual

**3.1 Mitigation Measures Construction**

Water Exposed Area

**3.2 Site Preparation - 2019**

**Unmitigated Construction On-Site**

	ROG	NOx	CO	SO2	Fugitive PM10	Exhaust PM10	PM10 Total	Fugitive PM2.5	Exhaust PM2.5	PM2.5 Total	Bio- CO2	NBio- CO2	Total CO2	CH4	N2O	CO2e
Category	tons/yr										MT/yr					
Fugitive Dust					1.7100e-003	0.0000	1.7100e-003	8.5000e-004	0.0000	8.5000e-004	0.0000	0.0000	0.0000	0.0000	0.0000	0.0000
Off-Road	7.2000e-004	8.0100e-003	4.5100e-003	1.0000e-005		3.7000e-004	3.7000e-004		3.4000e-004	3.4000e-004	0.0000	0.7796	0.7796	2.5000e-004	0.0000	0.7858
<b>Total</b>	<b>7.2000e-004</b>	<b>8.0100e-003</b>	<b>4.5100e-003</b>	<b>1.0000e-005</b>	<b>1.7100e-003</b>	<b>3.7000e-004</b>	<b>2.0800e-003</b>	<b>8.5000e-004</b>	<b>3.4000e-004</b>	<b>1.1900e-003</b>	<b>0.0000</b>	<b>0.7796</b>	<b>0.7796</b>	<b>2.5000e-004</b>	<b>0.0000</b>	<b>0.7858</b>

TVMWD Production Well - Los Angeles-South Coast County, Annual

**3.2 Site Preparation - 2019**

**Unmitigated Construction Off-Site**

	ROG	NOx	CO	SO2	Fugitive PM10	Exhaust PM10	PM10 Total	Fugitive PM2.5	Exhaust PM2.5	PM2.5 Total	Bio- CO2	NBio- CO2	Total CO2	CH4	N2O	CO2e
Category	tons/yr										MT/yr					
Hauling	0.0000	0.0000	0.0000	0.0000	0.0000	0.0000	0.0000	0.0000	0.0000	0.0000	0.0000	0.0000	0.0000	0.0000	0.0000	0.0000
Vendor	0.0000	0.0000	0.0000	0.0000	0.0000	0.0000	0.0000	0.0000	0.0000	0.0000	0.0000	0.0000	0.0000	0.0000	0.0000	0.0000
Worker	3.0000e-005	2.0000e-005	2.3000e-004	0.0000	5.0000e-005	0.0000	6.0000e-005	1.0000e-005	0.0000	1.0000e-005	0.0000	0.0527	0.0527	0.0000	0.0000	0.0527
<b>Total</b>	<b>3.0000e-005</b>	<b>2.0000e-005</b>	<b>2.3000e-004</b>	<b>0.0000</b>	<b>5.0000e-005</b>	<b>0.0000</b>	<b>6.0000e-005</b>	<b>1.0000e-005</b>	<b>0.0000</b>	<b>1.0000e-005</b>	<b>0.0000</b>	<b>0.0527</b>	<b>0.0527</b>	<b>0.0000</b>	<b>0.0000</b>	<b>0.0527</b>

**Mitigated Construction On-Site**

	ROG	NOx	CO	SO2	Fugitive PM10	Exhaust PM10	PM10 Total	Fugitive PM2.5	Exhaust PM2.5	PM2.5 Total	Bio- CO2	NBio- CO2	Total CO2	CH4	N2O	CO2e
Category	tons/yr										MT/yr					
Fugitive Dust					7.7000e-004	0.0000	7.7000e-004	3.8000e-004	0.0000	3.8000e-004	0.0000	0.0000	0.0000	0.0000	0.0000	0.0000
Off-Road	7.2000e-004	8.0100e-003	4.5100e-003	1.0000e-005		3.7000e-004	3.7000e-004		3.4000e-004	3.4000e-004	0.0000	0.7796	0.7796	2.5000e-004	0.0000	0.7858
<b>Total</b>	<b>7.2000e-004</b>	<b>8.0100e-003</b>	<b>4.5100e-003</b>	<b>1.0000e-005</b>	<b>7.7000e-004</b>	<b>3.7000e-004</b>	<b>1.1400e-003</b>	<b>3.8000e-004</b>	<b>3.4000e-004</b>	<b>7.2000e-004</b>	<b>0.0000</b>	<b>0.7796</b>	<b>0.7796</b>	<b>2.5000e-004</b>	<b>0.0000</b>	<b>0.7858</b>

TVMWD Production Well - Los Angeles-South Coast County, Annual

**3.2 Site Preparation - 2019**

**Mitigated Construction Off-Site**

	ROG	NOx	CO	SO2	Fugitive PM10	Exhaust PM10	PM10 Total	Fugitive PM2.5	Exhaust PM2.5	PM2.5 Total	Bio- CO2	NBio- CO2	Total CO2	CH4	N2O	CO2e
Category	tons/yr										MT/yr					
Hauling	0.0000	0.0000	0.0000	0.0000	0.0000	0.0000	0.0000	0.0000	0.0000	0.0000	0.0000	0.0000	0.0000	0.0000	0.0000	0.0000
Vendor	0.0000	0.0000	0.0000	0.0000	0.0000	0.0000	0.0000	0.0000	0.0000	0.0000	0.0000	0.0000	0.0000	0.0000	0.0000	0.0000
Worker	3.0000e-005	2.0000e-005	2.3000e-004	0.0000	5.0000e-005	0.0000	6.0000e-005	1.0000e-005	0.0000	1.0000e-005	0.0000	0.0527	0.0527	0.0000	0.0000	0.0527
<b>Total</b>	<b>3.0000e-005</b>	<b>2.0000e-005</b>	<b>2.3000e-004</b>	<b>0.0000</b>	<b>5.0000e-005</b>	<b>0.0000</b>	<b>6.0000e-005</b>	<b>1.0000e-005</b>	<b>0.0000</b>	<b>1.0000e-005</b>	<b>0.0000</b>	<b>0.0527</b>	<b>0.0527</b>	<b>0.0000</b>	<b>0.0000</b>	<b>0.0527</b>

**3.3 Grading - 2019**

**Unmitigated Construction On-Site**

	ROG	NOx	CO	SO2	Fugitive PM10	Exhaust PM10	PM10 Total	Fugitive PM2.5	Exhaust PM2.5	PM2.5 Total	Bio- CO2	NBio- CO2	Total CO2	CH4	N2O	CO2e
Category	tons/yr										MT/yr					
Fugitive Dust					3.2800e-003	0.0000	3.2800e-003	1.6800e-003	0.0000	1.6800e-003	0.0000	0.0000	0.0000	0.0000	0.0000	0.0000
Off-Road	1.5500e-003	0.0157	9.8000e-003	2.0000e-005		7.9000e-004	7.9000e-004		7.4000e-004	7.4000e-004	0.0000	1.6184	1.6184	3.8000e-004	0.0000	1.6279
<b>Total</b>	<b>1.5500e-003</b>	<b>0.0157</b>	<b>9.8000e-003</b>	<b>2.0000e-005</b>	<b>3.2800e-003</b>	<b>7.9000e-004</b>	<b>4.0700e-003</b>	<b>1.6800e-003</b>	<b>7.4000e-004</b>	<b>2.4200e-003</b>	<b>0.0000</b>	<b>1.6184</b>	<b>1.6184</b>	<b>3.8000e-004</b>	<b>0.0000</b>	<b>1.6279</b>

TVMWD Production Well - Los Angeles-South Coast County, Annual

**3.3 Grading - 2019**

**Unmitigated Construction Off-Site**

	ROG	NOx	CO	SO2	Fugitive PM10	Exhaust PM10	PM10 Total	Fugitive PM2.5	Exhaust PM2.5	PM2.5 Total	Bio- CO2	NBio- CO2	Total CO2	CH4	N2O	CO2e
Category	tons/yr										MT/yr					
Hauling	0.0000	0.0000	0.0000	0.0000	0.0000	0.0000	0.0000	0.0000	0.0000	0.0000	0.0000	0.0000	0.0000	0.0000	0.0000	0.0000
Vendor	0.0000	0.0000	0.0000	0.0000	0.0000	0.0000	0.0000	0.0000	0.0000	0.0000	0.0000	0.0000	0.0000	0.0000	0.0000	0.0000
Worker	5.0000e-005	4.0000e-005	4.5000e-004	0.0000	1.1000e-004	0.0000	1.1000e-004	3.0000e-005	0.0000	3.0000e-005	0.0000	0.1053	0.1053	0.0000	0.0000	0.1054
<b>Total</b>	<b>5.0000e-005</b>	<b>4.0000e-005</b>	<b>4.5000e-004</b>	<b>0.0000</b>	<b>1.1000e-004</b>	<b>0.0000</b>	<b>1.1000e-004</b>	<b>3.0000e-005</b>	<b>0.0000</b>	<b>3.0000e-005</b>	<b>0.0000</b>	<b>0.1053</b>	<b>0.1053</b>	<b>0.0000</b>	<b>0.0000</b>	<b>0.1054</b>

**Mitigated Construction On-Site**

	ROG	NOx	CO	SO2	Fugitive PM10	Exhaust PM10	PM10 Total	Fugitive PM2.5	Exhaust PM2.5	PM2.5 Total	Bio- CO2	NBio- CO2	Total CO2	CH4	N2O	CO2e
Category	tons/yr										MT/yr					
Fugitive Dust					1.4700e-003	0.0000	1.4700e-003	7.6000e-004	0.0000	7.6000e-004	0.0000	0.0000	0.0000	0.0000	0.0000	0.0000
Off-Road	1.5500e-003	0.0157	9.8000e-003	2.0000e-005		7.9000e-004	7.9000e-004		7.4000e-004	7.4000e-004	0.0000	1.6184	1.6184	3.8000e-004	0.0000	1.6279
<b>Total</b>	<b>1.5500e-003</b>	<b>0.0157</b>	<b>9.8000e-003</b>	<b>2.0000e-005</b>	<b>1.4700e-003</b>	<b>7.9000e-004</b>	<b>2.2600e-003</b>	<b>7.6000e-004</b>	<b>7.4000e-004</b>	<b>1.5000e-003</b>	<b>0.0000</b>	<b>1.6184</b>	<b>1.6184</b>	<b>3.8000e-004</b>	<b>0.0000</b>	<b>1.6279</b>



TVMWD Production Well - Los Angeles-South Coast County, Annual

**3.3 Grading - 2019**

**Mitigated Construction Off-Site**

	ROG	NOx	CO	SO2	Fugitive PM10	Exhaust PM10	PM10 Total	Fugitive PM2.5	Exhaust PM2.5	PM2.5 Total	Bio- CO2	NBio- CO2	Total CO2	CH4	N2O	CO2e
Category	tons/yr										MT/yr					
Hauling	0.0000	0.0000	0.0000	0.0000	0.0000	0.0000	0.0000	0.0000	0.0000	0.0000	0.0000	0.0000	0.0000	0.0000	0.0000	0.0000
Vendor	0.0000	0.0000	0.0000	0.0000	0.0000	0.0000	0.0000	0.0000	0.0000	0.0000	0.0000	0.0000	0.0000	0.0000	0.0000	0.0000
Worker	5.0000e-005	4.0000e-005	4.5000e-004	0.0000	1.1000e-004	0.0000	1.1000e-004	3.0000e-005	0.0000	3.0000e-005	0.0000	0.1053	0.1053	0.0000	0.0000	0.1054
<b>Total</b>	<b>5.0000e-005</b>	<b>4.0000e-005</b>	<b>4.5000e-004</b>	<b>0.0000</b>	<b>1.1000e-004</b>	<b>0.0000</b>	<b>1.1000e-004</b>	<b>3.0000e-005</b>	<b>0.0000</b>	<b>3.0000e-005</b>	<b>0.0000</b>	<b>0.1053</b>	<b>0.1053</b>	<b>0.0000</b>	<b>0.0000</b>	<b>0.1054</b>

**3.4 Building Construction - 2019**

**Unmitigated Construction On-Site**

	ROG	NOx	CO	SO2	Fugitive PM10	Exhaust PM10	PM10 Total	Fugitive PM2.5	Exhaust PM2.5	PM2.5 Total	Bio- CO2	NBio- CO2	Total CO2	CH4	N2O	CO2e
Category	tons/yr										MT/yr					
Off-Road	0.0662	0.6709	0.4816	1.0600e-003		0.0336	0.0336		0.0318	0.0318	0.0000	94.1270	94.1270	0.0231	0.0000	94.7053
<b>Total</b>	<b>0.0662</b>	<b>0.6709</b>	<b>0.4816</b>	<b>1.0600e-003</b>		<b>0.0336</b>	<b>0.0336</b>		<b>0.0318</b>	<b>0.0318</b>	<b>0.0000</b>	<b>94.1270</b>	<b>94.1270</b>	<b>0.0231</b>	<b>0.0000</b>	<b>94.7053</b>

TVMWD Production Well - Los Angeles-South Coast County, Annual

**3.4 Building Construction - 2019**

**Unmitigated Construction Off-Site**

	ROG	NOx	CO	SO2	Fugitive PM10	Exhaust PM10	PM10 Total	Fugitive PM2.5	Exhaust PM2.5	PM2.5 Total	Bio- CO2	NBio- CO2	Total CO2	CH4	N2O	CO2e
Category	tons/yr										MT/yr					
Hauling	0.0000	0.0000	0.0000	0.0000	0.0000	0.0000	0.0000	0.0000	0.0000	0.0000	0.0000	0.0000	0.0000	0.0000	0.0000	0.0000
Vendor	1.9000e-004	5.3200e-003	1.4500e-003	1.0000e-005	2.8000e-004	3.0000e-005	3.2000e-004	8.0000e-005	3.0000e-005	1.1000e-004	0.0000	1.1253	1.1253	8.0000e-005	0.0000	1.1272
Worker	5.3000e-004	4.4000e-004	4.7700e-003	1.0000e-005	1.1500e-003	1.0000e-005	1.1600e-003	3.1000e-004	1.0000e-005	3.1000e-004	0.0000	1.1060	1.1060	4.0000e-005	0.0000	1.1070
<b>Total</b>	<b>7.2000e-004</b>	<b>5.7600e-003</b>	<b>6.2200e-003</b>	<b>2.0000e-005</b>	<b>1.4300e-003</b>	<b>4.0000e-005</b>	<b>1.4800e-003</b>	<b>3.9000e-004</b>	<b>4.0000e-005</b>	<b>4.2000e-004</b>	<b>0.0000</b>	<b>2.2313</b>	<b>2.2313</b>	<b>1.2000e-004</b>	<b>0.0000</b>	<b>2.2342</b>

**Mitigated Construction On-Site**

	ROG	NOx	CO	SO2	Fugitive PM10	Exhaust PM10	PM10 Total	Fugitive PM2.5	Exhaust PM2.5	PM2.5 Total	Bio- CO2	NBio- CO2	Total CO2	CH4	N2O	CO2e
Category	tons/yr										MT/yr					
Off-Road	0.0662	0.6709	0.4816	1.0600e-003		0.0336	0.0336		0.0318	0.0318	0.0000	94.1269	94.1269	0.0231	0.0000	94.7052
<b>Total</b>	<b>0.0662</b>	<b>0.6709</b>	<b>0.4816</b>	<b>1.0600e-003</b>		<b>0.0336</b>	<b>0.0336</b>		<b>0.0318</b>	<b>0.0318</b>	<b>0.0000</b>	<b>94.1269</b>	<b>94.1269</b>	<b>0.0231</b>	<b>0.0000</b>	<b>94.7052</b>

TVMWD Production Well - Los Angeles-South Coast County, Annual

**3.4 Building Construction - 2019**

**Mitigated Construction Off-Site**

	ROG	NOx	CO	SO2	Fugitive PM10	Exhaust PM10	PM10 Total	Fugitive PM2.5	Exhaust PM2.5	PM2.5 Total	Bio- CO2	NBio- CO2	Total CO2	CH4	N2O	CO2e
Category	tons/yr										MT/yr					
Hauling	0.0000	0.0000	0.0000	0.0000	0.0000	0.0000	0.0000	0.0000	0.0000	0.0000	0.0000	0.0000	0.0000	0.0000	0.0000	0.0000
Vendor	1.9000e-004	5.3200e-003	1.4500e-003	1.0000e-005	2.8000e-004	3.0000e-005	3.2000e-004	8.0000e-005	3.0000e-005	1.1000e-004	0.0000	1.1253	1.1253	8.0000e-005	0.0000	1.1272
Worker	5.3000e-004	4.4000e-004	4.7700e-003	1.0000e-005	1.1500e-003	1.0000e-005	1.1600e-003	3.1000e-004	1.0000e-005	3.1000e-004	0.0000	1.1060	1.1060	4.0000e-005	0.0000	1.1070
<b>Total</b>	<b>7.2000e-004</b>	<b>5.7600e-003</b>	<b>6.2200e-003</b>	<b>2.0000e-005</b>	<b>1.4300e-003</b>	<b>4.0000e-005</b>	<b>1.4800e-003</b>	<b>3.9000e-004</b>	<b>4.0000e-005</b>	<b>4.2000e-004</b>	<b>0.0000</b>	<b>2.2313</b>	<b>2.2313</b>	<b>1.2000e-004</b>	<b>0.0000</b>	<b>2.2342</b>

**3.4 Building Construction - 2020**

**Unmitigated Construction On-Site**

	ROG	NOx	CO	SO2	Fugitive PM10	Exhaust PM10	PM10 Total	Fugitive PM2.5	Exhaust PM2.5	PM2.5 Total	Bio- CO2	NBio- CO2	Total CO2	CH4	N2O	CO2e
Category	tons/yr										MT/yr					
Off-Road	0.0574	0.5816	0.4455	9.9000e-004		0.0282	0.0282		0.0266	0.0266	0.0000	86.5890	86.5890	0.0214	0.0000	87.1248
<b>Total</b>	<b>0.0574</b>	<b>0.5816</b>	<b>0.4455</b>	<b>9.9000e-004</b>		<b>0.0282</b>	<b>0.0282</b>		<b>0.0266</b>	<b>0.0266</b>	<b>0.0000</b>	<b>86.5890</b>	<b>86.5890</b>	<b>0.0214</b>	<b>0.0000</b>	<b>87.1248</b>

TVMWD Production Well - Los Angeles-South Coast County, Annual

**3.4 Building Construction - 2020**

**Unmitigated Construction Off-Site**

	ROG	NOx	CO	SO2	Fugitive PM10	Exhaust PM10	PM10 Total	Fugitive PM2.5	Exhaust PM2.5	PM2.5 Total	Bio- CO2	NBio- CO2	Total CO2	CH4	N2O	CO2e
Category	tons/yr										MT/yr					
Hauling	0.0000	0.0000	0.0000	0.0000	0.0000	0.0000	0.0000	0.0000	0.0000	0.0000	0.0000	0.0000	0.0000	0.0000	0.0000	0.0000
Vendor	1.5000e-004	4.5500e-003	1.2300e-003	1.0000e-005	2.6000e-004	2.0000e-005	2.9000e-004	8.0000e-005	2.0000e-005	1.0000e-004	0.0000	1.0434	1.0434	7.0000e-005	0.0000	1.0451
Worker	4.5000e-004	3.6000e-004	4.0300e-003	1.0000e-005	1.0700e-003	1.0000e-005	1.0800e-003	2.9000e-004	1.0000e-005	2.9000e-004	0.0000	1.0009	1.0009	3.0000e-005	0.0000	1.0017
<b>Total</b>	<b>6.0000e-004</b>	<b>4.9100e-003</b>	<b>5.2600e-003</b>	<b>2.0000e-005</b>	<b>1.3300e-003</b>	<b>3.0000e-005</b>	<b>1.3700e-003</b>	<b>3.7000e-004</b>	<b>3.0000e-005</b>	<b>3.9000e-004</b>	<b>0.0000</b>	<b>2.0443</b>	<b>2.0443</b>	<b>1.0000e-004</b>	<b>0.0000</b>	<b>2.0468</b>

**Mitigated Construction On-Site**

	ROG	NOx	CO	SO2	Fugitive PM10	Exhaust PM10	PM10 Total	Fugitive PM2.5	Exhaust PM2.5	PM2.5 Total	Bio- CO2	NBio- CO2	Total CO2	CH4	N2O	CO2e
Category	tons/yr										MT/yr					
Off-Road	0.0574	0.5816	0.4455	9.9000e-004		0.0282	0.0282		0.0266	0.0266	0.0000	86.5889	86.5889	0.0214	0.0000	87.1247
<b>Total</b>	<b>0.0574</b>	<b>0.5816</b>	<b>0.4455</b>	<b>9.9000e-004</b>		<b>0.0282</b>	<b>0.0282</b>		<b>0.0266</b>	<b>0.0266</b>	<b>0.0000</b>	<b>86.5889</b>	<b>86.5889</b>	<b>0.0214</b>	<b>0.0000</b>	<b>87.1247</b>

TVMWD Production Well - Los Angeles-South Coast County, Annual

**3.4 Building Construction - 2020**

**Mitigated Construction Off-Site**

	ROG	NOx	CO	SO2	Fugitive PM10	Exhaust PM10	PM10 Total	Fugitive PM2.5	Exhaust PM2.5	PM2.5 Total	Bio- CO2	NBio- CO2	Total CO2	CH4	N2O	CO2e
Category	tons/yr										MT/yr					
Hauling	0.0000	0.0000	0.0000	0.0000	0.0000	0.0000	0.0000	0.0000	0.0000	0.0000	0.0000	0.0000	0.0000	0.0000	0.0000	0.0000
Vendor	1.5000e-004	4.5500e-003	1.2300e-003	1.0000e-005	2.6000e-004	2.0000e-005	2.9000e-004	8.0000e-005	2.0000e-005	1.0000e-004	0.0000	1.0434	1.0434	7.0000e-005	0.0000	1.0451
Worker	4.5000e-004	3.6000e-004	4.0300e-003	1.0000e-005	1.0700e-003	1.0000e-005	1.0800e-003	2.9000e-004	1.0000e-005	2.9000e-004	0.0000	1.0009	1.0009	3.0000e-005	0.0000	1.0017
<b>Total</b>	<b>6.0000e-004</b>	<b>4.9100e-003</b>	<b>5.2600e-003</b>	<b>2.0000e-005</b>	<b>1.3300e-003</b>	<b>3.0000e-005</b>	<b>1.3700e-003</b>	<b>3.7000e-004</b>	<b>3.0000e-005</b>	<b>3.9000e-004</b>	<b>0.0000</b>	<b>2.0443</b>	<b>2.0443</b>	<b>1.0000e-004</b>	<b>0.0000</b>	<b>2.0468</b>

**3.5 Paving - 2020**

**Unmitigated Construction On-Site**

	ROG	NOx	CO	SO2	Fugitive PM10	Exhaust PM10	PM10 Total	Fugitive PM2.5	Exhaust PM2.5	PM2.5 Total	Bio- CO2	NBio- CO2	Total CO2	CH4	N2O	CO2e
Category	tons/yr										MT/yr					
Off-Road	4.7100e-003	0.0488	0.0397	7.0000e-005		2.3400e-003	2.3400e-003		2.1900e-003	2.1900e-003	0.0000	6.3216	6.3216	1.6600e-003	0.0000	6.3631
Paving	3.0000e-004					0.0000	0.0000		0.0000	0.0000	0.0000	0.0000	0.0000	0.0000	0.0000	0.0000
<b>Total</b>	<b>5.0100e-003</b>	<b>0.0488</b>	<b>0.0397</b>	<b>7.0000e-005</b>		<b>2.3400e-003</b>	<b>2.3400e-003</b>		<b>2.1900e-003</b>	<b>2.1900e-003</b>	<b>0.0000</b>	<b>6.3216</b>	<b>6.3216</b>	<b>1.6600e-003</b>	<b>0.0000</b>	<b>6.3631</b>

TVMWD Production Well - Los Angeles-South Coast County, Annual

**3.5 Paving - 2020**

**Unmitigated Construction Off-Site**

	ROG	NOx	CO	SO2	Fugitive PM10	Exhaust PM10	PM10 Total	Fugitive PM2.5	Exhaust PM2.5	PM2.5 Total	Bio- CO2	NBio- CO2	Total CO2	CH4	N2O	CO2e
Category	tons/yr										MT/yr					
Hauling	0.0000	0.0000	0.0000	0.0000	0.0000	0.0000	0.0000	0.0000	0.0000	0.0000	0.0000	0.0000	0.0000	0.0000	0.0000	0.0000
Vendor	0.0000	0.0000	0.0000	0.0000	0.0000	0.0000	0.0000	0.0000	0.0000	0.0000	0.0000	0.0000	0.0000	0.0000	0.0000	0.0000
Worker	1.7000e-004	1.4000e-004	1.5400e-003	0.0000	4.1000e-004	0.0000	4.1000e-004	1.1000e-004	0.0000	1.1000e-004	0.0000	0.3830	0.3830	1.0000e-005	0.0000	0.3833
<b>Total</b>	<b>1.7000e-004</b>	<b>1.4000e-004</b>	<b>1.5400e-003</b>	<b>0.0000</b>	<b>4.1000e-004</b>	<b>0.0000</b>	<b>4.1000e-004</b>	<b>1.1000e-004</b>	<b>0.0000</b>	<b>1.1000e-004</b>	<b>0.0000</b>	<b>0.3830</b>	<b>0.3830</b>	<b>1.0000e-005</b>	<b>0.0000</b>	<b>0.3833</b>

**Mitigated Construction On-Site**

	ROG	NOx	CO	SO2	Fugitive PM10	Exhaust PM10	PM10 Total	Fugitive PM2.5	Exhaust PM2.5	PM2.5 Total	Bio- CO2	NBio- CO2	Total CO2	CH4	N2O	CO2e
Category	tons/yr										MT/yr					
Off-Road	4.7100e-003	0.0488	0.0397	7.0000e-005		2.3400e-003	2.3400e-003		2.1900e-003	2.1900e-003	0.0000	6.3216	6.3216	1.6600e-003	0.0000	6.3631
Paving	3.0000e-004					0.0000	0.0000		0.0000	0.0000	0.0000	0.0000	0.0000	0.0000	0.0000	0.0000
<b>Total</b>	<b>5.0100e-003</b>	<b>0.0488</b>	<b>0.0397</b>	<b>7.0000e-005</b>		<b>2.3400e-003</b>	<b>2.3400e-003</b>		<b>2.1900e-003</b>	<b>2.1900e-003</b>	<b>0.0000</b>	<b>6.3216</b>	<b>6.3216</b>	<b>1.6600e-003</b>	<b>0.0000</b>	<b>6.3631</b>

TVMWD Production Well - Los Angeles-South Coast County, Annual

**3.5 Paving - 2020**

**Mitigated Construction Off-Site**

	ROG	NOx	CO	SO2	Fugitive PM10	Exhaust PM10	PM10 Total	Fugitive PM2.5	Exhaust PM2.5	PM2.5 Total	Bio- CO2	NBio- CO2	Total CO2	CH4	N2O	CO2e
Category	tons/yr										MT/yr					
Hauling	0.0000	0.0000	0.0000	0.0000	0.0000	0.0000	0.0000	0.0000	0.0000	0.0000	0.0000	0.0000	0.0000	0.0000	0.0000	0.0000
Vendor	0.0000	0.0000	0.0000	0.0000	0.0000	0.0000	0.0000	0.0000	0.0000	0.0000	0.0000	0.0000	0.0000	0.0000	0.0000	0.0000
Worker	1.7000e-004	1.4000e-004	1.5400e-003	0.0000	4.1000e-004	0.0000	4.1000e-004	1.1000e-004	0.0000	1.1000e-004	0.0000	0.3830	0.3830	1.0000e-005	0.0000	0.3833
<b>Total</b>	<b>1.7000e-004</b>	<b>1.4000e-004</b>	<b>1.5400e-003</b>	<b>0.0000</b>	<b>4.1000e-004</b>	<b>0.0000</b>	<b>4.1000e-004</b>	<b>1.1000e-004</b>	<b>0.0000</b>	<b>1.1000e-004</b>	<b>0.0000</b>	<b>0.3830</b>	<b>0.3830</b>	<b>1.0000e-005</b>	<b>0.0000</b>	<b>0.3833</b>

**3.6 Architectural Coating - 2020**

**Unmitigated Construction On-Site**

	ROG	NOx	CO	SO2	Fugitive PM10	Exhaust PM10	PM10 Total	Fugitive PM2.5	Exhaust PM2.5	PM2.5 Total	Bio- CO2	NBio- CO2	Total CO2	CH4	N2O	CO2e
Category	tons/yr										MT/yr					
Archit. Coating	4.4000e-003					0.0000	0.0000		0.0000	0.0000	0.0000	0.0000	0.0000	0.0000	0.0000	0.0000
Off-Road	6.1000e-004	4.2100e-003	4.5800e-003	1.0000e-005		2.8000e-004	2.8000e-004		2.8000e-004	2.8000e-004	0.0000	0.6383	0.6383	5.0000e-005	0.0000	0.6396
<b>Total</b>	<b>5.0100e-003</b>	<b>4.2100e-003</b>	<b>4.5800e-003</b>	<b>1.0000e-005</b>		<b>2.8000e-004</b>	<b>2.8000e-004</b>		<b>2.8000e-004</b>	<b>2.8000e-004</b>	<b>0.0000</b>	<b>0.6383</b>	<b>0.6383</b>	<b>5.0000e-005</b>	<b>0.0000</b>	<b>0.6396</b>

TVMWD Production Well - Los Angeles-South Coast County, Annual

**3.6 Architectural Coating - 2020**

**Unmitigated Construction Off-Site**

	ROG	NOx	CO	SO2	Fugitive PM10	Exhaust PM10	PM10 Total	Fugitive PM2.5	Exhaust PM2.5	PM2.5 Total	Bio- CO2	NBio- CO2	Total CO2	CH4	N2O	CO2e
Category	tons/yr										MT/yr					
Hauling	0.0000	0.0000	0.0000	0.0000	0.0000	0.0000	0.0000	0.0000	0.0000	0.0000	0.0000	0.0000	0.0000	0.0000	0.0000	0.0000
Vendor	0.0000	0.0000	0.0000	0.0000	0.0000	0.0000	0.0000	0.0000	0.0000	0.0000	0.0000	0.0000	0.0000	0.0000	0.0000	0.0000
Worker	1.0000e-005	1.0000e-005	1.0000e-004	0.0000	3.0000e-005	0.0000	3.0000e-005	1.0000e-005	0.0000	1.0000e-005	0.0000	0.0255	0.0255	0.0000	0.0000	0.0256
<b>Total</b>	<b>1.0000e-005</b>	<b>1.0000e-005</b>	<b>1.0000e-004</b>	<b>0.0000</b>	<b>3.0000e-005</b>	<b>0.0000</b>	<b>3.0000e-005</b>	<b>1.0000e-005</b>	<b>0.0000</b>	<b>1.0000e-005</b>	<b>0.0000</b>	<b>0.0255</b>	<b>0.0255</b>	<b>0.0000</b>	<b>0.0000</b>	<b>0.0256</b>

**Mitigated Construction On-Site**

	ROG	NOx	CO	SO2	Fugitive PM10	Exhaust PM10	PM10 Total	Fugitive PM2.5	Exhaust PM2.5	PM2.5 Total	Bio- CO2	NBio- CO2	Total CO2	CH4	N2O	CO2e
Category	tons/yr										MT/yr					
Archit. Coating	4.4000e-003					0.0000	0.0000		0.0000	0.0000	0.0000	0.0000	0.0000	0.0000	0.0000	0.0000
Off-Road	6.1000e-004	4.2100e-003	4.5800e-003	1.0000e-005		2.8000e-004	2.8000e-004		2.8000e-004	2.8000e-004	0.0000	0.6383	0.6383	5.0000e-005	0.0000	0.6396
<b>Total</b>	<b>5.0100e-003</b>	<b>4.2100e-003</b>	<b>4.5800e-003</b>	<b>1.0000e-005</b>		<b>2.8000e-004</b>	<b>2.8000e-004</b>		<b>2.8000e-004</b>	<b>2.8000e-004</b>	<b>0.0000</b>	<b>0.6383</b>	<b>0.6383</b>	<b>5.0000e-005</b>	<b>0.0000</b>	<b>0.6396</b>



TVMWD Production Well - Los Angeles-South Coast County, Annual

**3.6 Architectural Coating - 2020**

**Mitigated Construction Off-Site**

	ROG	NOx	CO	SO2	Fugitive PM10	Exhaust PM10	PM10 Total	Fugitive PM2.5	Exhaust PM2.5	PM2.5 Total	Bio- CO2	NBio- CO2	Total CO2	CH4	N2O	CO2e
Category	tons/yr										MT/yr					
Hauling	0.0000	0.0000	0.0000	0.0000	0.0000	0.0000	0.0000	0.0000	0.0000	0.0000	0.0000	0.0000	0.0000	0.0000	0.0000	0.0000
Vendor	0.0000	0.0000	0.0000	0.0000	0.0000	0.0000	0.0000	0.0000	0.0000	0.0000	0.0000	0.0000	0.0000	0.0000	0.0000	0.0000
Worker	1.0000e-005	1.0000e-005	1.0000e-004	0.0000	3.0000e-005	0.0000	3.0000e-005	1.0000e-005	0.0000	1.0000e-005	0.0000	0.0255	0.0255	0.0000	0.0000	0.0256
<b>Total</b>	<b>1.0000e-005</b>	<b>1.0000e-005</b>	<b>1.0000e-004</b>	<b>0.0000</b>	<b>3.0000e-005</b>	<b>0.0000</b>	<b>3.0000e-005</b>	<b>1.0000e-005</b>	<b>0.0000</b>	<b>1.0000e-005</b>	<b>0.0000</b>	<b>0.0255</b>	<b>0.0255</b>	<b>0.0000</b>	<b>0.0000</b>	<b>0.0256</b>

**4.0 Operational Detail - Mobile**

---

**4.1 Mitigation Measures Mobile**

TVMWD Production Well - Los Angeles-South Coast County, Annual

	ROG	NOx	CO	SO2	Fugitive PM10	Exhaust PM10	PM10 Total	Fugitive PM2.5	Exhaust PM2.5	PM2.5 Total	Bio- CO2	NBio- CO2	Total CO2	CH4	N2O	CO2e
Category	tons/yr										MT/yr					
Mitigated	9.0000e-005	4.7000e-004	1.2000e-003	0.0000	3.6000e-004	0.0000	3.6000e-004	1.0000e-004	0.0000	1.0000e-004	0.0000	0.4008	0.4008	2.0000e-005	0.0000	0.4013
Unmitigated	9.0000e-005	4.7000e-004	1.2000e-003	0.0000	3.6000e-004	0.0000	3.6000e-004	1.0000e-004	0.0000	1.0000e-004	0.0000	0.4008	0.4008	2.0000e-005	0.0000	0.4013

4.2 Trip Summary Information

Land Use	Average Daily Trip Rate			Unmitigated	Mitigated
	Weekday	Saturday	Sunday	Annual VMT	Annual VMT
Other Non-Asphalt Surfaces	0.00	0.00	0.00		
Parking Lot	0.00	0.00	0.00		
User Defined Industrial	0.43	0.00	0.00	939	939
Total	0.43	0.00	0.00	939	939

4.3 Trip Type Information

Land Use	Miles			Trip %			Trip Purpose %		
	H-W or C-W	H-S or C-C	H-O or C-NW	H-W or C-W	H-S or C-C	H-O or C-NW	Primary	Diverted	Pass-by
Other Non-Asphalt Surfaces	16.60	8.40	6.90	0.00	0.00	0.00	0	0	0
Parking Lot	16.60	8.40	6.90	0.00	0.00	0.00	0	0	0
User Defined Industrial	16.60	8.40	6.90	0.00	100.00	0.00	100	0	0

4.4 Fleet Mix





TVMWD Production Well - Los Angeles-South Coast County, Annual

**5.3 Energy by Land Use - Electricity**

**Unmitigated**

	Electricity Use	Total CO2	CH4	N2O	CO2e
Land Use	kWh/yr	MT/yr			
Other Non-Asphalt Surfaces	0	0.0000	0.0000	0.0000	0.0000
Parking Lot	3500	1.1152	5.0000e-005	1.0000e-005	1.1192
User Defined Industrial	0	0.0000	0.0000	0.0000	0.0000
<b>Total</b>		<b>1.1152</b>	<b>5.0000e-005</b>	<b>1.0000e-005</b>	<b>1.1192</b>

**Mitigated**

	Electricity Use	Total CO2	CH4	N2O	CO2e
Land Use	kWh/yr	MT/yr			
Other Non-Asphalt Surfaces	0	0.0000	0.0000	0.0000	0.0000
Parking Lot	3500	1.1152	5.0000e-005	1.0000e-005	1.1192
User Defined Industrial	0	0.0000	0.0000	0.0000	0.0000
<b>Total</b>		<b>1.1152</b>	<b>5.0000e-005</b>	<b>1.0000e-005</b>	<b>1.1192</b>

**6.0 Area Detail**

TVMWD Production Well - Los Angeles-South Coast County, Annual

**6.1 Mitigation Measures Area**

	ROG	NOx	CO	SO2	Fugitive PM10	Exhaust PM10	PM10 Total	Fugitive PM2.5	Exhaust PM2.5	PM2.5 Total	Bio- CO2	NBio- CO2	Total CO2	CH4	N2O	CO2e
Category	tons/yr										MT/yr					
Mitigated	3.2400e-003	0.0000	2.0000e-004	0.0000		0.0000	0.0000		0.0000	0.0000	0.0000	4.0000e-004	4.0000e-004	0.0000	0.0000	4.2000e-004
Unmitigated	3.2400e-003	0.0000	2.0000e-004	0.0000		0.0000	0.0000		0.0000	0.0000	0.0000	4.0000e-004	4.0000e-004	0.0000	0.0000	4.2000e-004

**6.2 Area by SubCategory**

**Unmitigated**

	ROG	NOx	CO	SO2	Fugitive PM10	Exhaust PM10	PM10 Total	Fugitive PM2.5	Exhaust PM2.5	PM2.5 Total	Bio- CO2	NBio- CO2	Total CO2	CH4	N2O	CO2e
SubCategory	tons/yr										MT/yr					
Architectural Coating	4.4000e-004					0.0000	0.0000		0.0000	0.0000	0.0000	0.0000	0.0000	0.0000	0.0000	0.0000
Consumer Products	2.7800e-003					0.0000	0.0000		0.0000	0.0000	0.0000	0.0000	0.0000	0.0000	0.0000	0.0000
Landscaping	2.0000e-005	0.0000	2.0000e-004	0.0000		0.0000	0.0000		0.0000	0.0000	0.0000	4.0000e-004	4.0000e-004	0.0000	0.0000	4.2000e-004
<b>Total</b>	<b>3.2400e-003</b>	<b>0.0000</b>	<b>2.0000e-004</b>	<b>0.0000</b>		<b>0.0000</b>	<b>0.0000</b>		<b>0.0000</b>	<b>0.0000</b>	<b>0.0000</b>	<b>4.0000e-004</b>	<b>4.0000e-004</b>	<b>0.0000</b>	<b>0.0000</b>	<b>4.2000e-004</b>

TVMWD Production Well - Los Angeles-South Coast County, Annual

**6.2 Area by SubCategory**

**Mitigated**

	ROG	NOx	CO	SO2	Fugitive PM10	Exhaust PM10	PM10 Total	Fugitive PM2.5	Exhaust PM2.5	PM2.5 Total	Bio- CO2	NBio- CO2	Total CO2	CH4	N2O	CO2e
SubCategory	tons/yr										MT/yr					
Architectural Coating	4.4000e-004					0.0000	0.0000		0.0000	0.0000	0.0000	0.0000	0.0000	0.0000	0.0000	0.0000
Consumer Products	2.7800e-003					0.0000	0.0000		0.0000	0.0000	0.0000	0.0000	0.0000	0.0000	0.0000	0.0000
Landscaping	2.0000e-005	0.0000	2.0000e-004	0.0000		0.0000	0.0000		0.0000	0.0000	0.0000	4.0000e-004	4.0000e-004	0.0000	0.0000	4.2000e-004
<b>Total</b>	<b>3.2400e-003</b>	<b>0.0000</b>	<b>2.0000e-004</b>	<b>0.0000</b>		<b>0.0000</b>	<b>0.0000</b>		<b>0.0000</b>	<b>0.0000</b>	<b>0.0000</b>	<b>4.0000e-004</b>	<b>4.0000e-004</b>	<b>0.0000</b>	<b>0.0000</b>	<b>4.2000e-004</b>

**7.0 Water Detail**

---

**7.1 Mitigation Measures Water**

TVMWD Production Well - Los Angeles-South Coast County, Annual

	Total CO2	CH4	N2O	CO2e
Category	MT/yr			
Mitigated	0.0000	0.0000	0.0000	0.0000
Unmitigated	0.0000	0.0000	0.0000	0.0000

7.2 Water by Land Use

Unmitigated

	Indoor/Outdoor Use	Total CO2	CH4	N2O	CO2e
Land Use	Mgal	MT/yr			
Other Non-Asphalt Surfaces	0 / 0	0.0000	0.0000	0.0000	0.0000
Parking Lot	0 / 0	0.0000	0.0000	0.0000	0.0000
User Defined Industrial	0 / 0	0.0000	0.0000	0.0000	0.0000
<b>Total</b>		<b>0.0000</b>	<b>0.0000</b>	<b>0.0000</b>	<b>0.0000</b>



TVMWD Production Well - Los Angeles-South Coast County, Annual

**7.2 Water by Land Use**

**Mitigated**

	Indoor/Outdoor Use	Total CO2	CH4	N2O	CO2e
Land Use	Mgal	MT/yr			
Other Non-Asphalt Surfaces	0 / 0	0.0000	0.0000	0.0000	0.0000
Parking Lot	0 / 0	0.0000	0.0000	0.0000	0.0000
User Defined Industrial	0 / 0	0.0000	0.0000	0.0000	0.0000
<b>Total</b>		<b>0.0000</b>	<b>0.0000</b>	<b>0.0000</b>	<b>0.0000</b>

**8.0 Waste Detail**

---

**8.1 Mitigation Measures Waste**

TVMWD Production Well - Los Angeles-South Coast County, Annual

**Category/Year**

	Total CO2	CH4	N2O	CO2e
	MT/yr			
Mitigated	0.0000	0.0000	0.0000	0.0000
Unmitigated	0.0000	0.0000	0.0000	0.0000

**8.2 Waste by Land Use**

**Unmitigated**

	Waste Disposed	Total CO2	CH4	N2O	CO2e
Land Use	tons	MT/yr			
Other Non-Asphalt Surfaces	0	0.0000	0.0000	0.0000	0.0000
Parking Lot	0	0.0000	0.0000	0.0000	0.0000
User Defined Industrial	0	0.0000	0.0000	0.0000	0.0000
<b>Total</b>		<b>0.0000</b>	<b>0.0000</b>	<b>0.0000</b>	<b>0.0000</b>

TVMWD Production Well - Los Angeles-South Coast County, Annual

**8.2 Waste by Land Use**

**Mitigated**

	Waste Disposed	Total CO2	CH4	N2O	CO2e
Land Use	tons	MT/yr			
Other Non-Asphalt Surfaces	0	0.0000	0.0000	0.0000	0.0000
Parking Lot	0	0.0000	0.0000	0.0000	0.0000
User Defined Industrial	0	0.0000	0.0000	0.0000	0.0000
<b>Total</b>		<b>0.0000</b>	<b>0.0000</b>	<b>0.0000</b>	<b>0.0000</b>

**9.0 Operational Offroad**

Equipment Type	Number	Hours/Day	Days/Year	Horse Power	Load Factor	Fuel Type
----------------	--------	-----------	-----------	-------------	-------------	-----------

**10.0 Stationary Equipment**

**Fire Pumps and Emergency Generators**

Equipment Type	Number	Hours/Day	Hours/Year	Horse Power	Load Factor	Fuel Type
----------------	--------	-----------	------------	-------------	-------------	-----------

**Boilers**

Equipment Type	Number	Heat Input/Day	Heat Input/Year	Boiler Rating	Fuel Type
----------------	--------	----------------	-----------------	---------------	-----------

**User Defined Equipment**

Equipment Type	Number
----------------	--------

## 11.0 Vegetation

---

TVMWD Production Well - Los Angeles-South Coast County, Summer

**TVMWD Production Well**  
**Los Angeles-South Coast County, Summer**

**1.0 Project Characteristics**

**1.1 Land Usage**

Land Uses	Size	Metric	Lot Acreage	Floor Surface Area	Population
User Defined Industrial	1.00	User Defined Unit	0.10	500.00	0
Other Non-Asphalt Surfaces	5.00	1000sqft	0.11	5,000.00	0
Parking Lot	10.00	1000sqft	0.23	10,000.00	0

**1.2 Other Project Characteristics**

<b>Urbanization</b>	Urban	<b>Wind Speed (m/s)</b>	2.2	<b>Precipitation Freq (Days)</b>	33
<b>Climate Zone</b>	10			<b>Operational Year</b>	2022
<b>Utility Company</b>	Southern California Edison				
<b>CO2 Intensity (lb/MWhr)</b>	702.44	<b>CH4 Intensity (lb/MWhr)</b>	0.029	<b>N2O Intensity (lb/MWhr)</b>	0.006

**1.3 User Entered Comments & Non-Default Data**

TVMWD Production Well - Los Angeles-South Coast County, Summer

Project Characteristics -

Land Use - Site plan

Construction Phase - Per construction contractor

Off-road Equipment - Per contractor

Off-road Equipment - Per contractor

Off-road Equipment - Per contractor

Off-road Equipment - Per contractor

Off-road Equipment - Per contractor

Demolition -

Vehicle Trips - Per applicant

Construction Off-road Equipment Mitigation -

TVMWD Production Well - Los Angeles-South Coast County, Summer

Table Name	Column Name	Default Value	New Value
tblConstructionPhase	NumDays	100.00	58.00
tblLandUse	LandUseSquareFeet	0.00	500.00
tblLandUse	LotAcreage	0.00	0.10
tblOffRoadEquipment	HorsePower	132.00	172.00
tblOffRoadEquipment	LoadFactor	0.36	0.42
tblOffRoadEquipment	OffRoadEquipmentUnitAmount	4.00	1.00
tblOffRoadEquipment	OffRoadEquipmentUnitAmount	2.00	1.00
tblOffRoadEquipment	UsageHours	8.00	6.00
tblOffRoadEquipment	UsageHours	1.00	4.00
tblOffRoadEquipment	UsageHours	6.00	4.00
tblOffRoadEquipment	UsageHours	8.00	6.00
tblTripsAndVMT	WorkerTripNumber	13.00	10.00
tblTripsAndVMT	WorkerTripNumber	20.00	15.00
tblVehicleTrips	CC_TTP	0.00	100.00
tblVehicleTrips	PR_TP	0.00	100.00
tblVehicleTrips	WD_TR	0.00	0.43

**2.0 Emissions Summary**

---





TVMWD Production Well - Los Angeles-South Coast County, Summer

**2.2 Overall Operational**

**Unmitigated Operational**

	ROG	NOx	CO	SO2	Fugitive PM10	Exhaust PM10	PM10 Total	Fugitive PM2.5	Exhaust PM2.5	PM2.5 Total	Bio- CO2	NBio- CO2	Total CO2	CH4	N2O	CO2e
Category	lb/day										lb/day					
Area	0.0178	1.0000e-005	1.6400e-003	0.0000		1.0000e-005	1.0000e-005		1.0000e-005	1.0000e-005		3.5000e-003	3.5000e-003	1.0000e-005		3.7300e-003
Energy	0.0000	0.0000	0.0000	0.0000		0.0000	0.0000		0.0000	0.0000		0.0000	0.0000	0.0000	0.0000	0.0000
Mobile	7.4000e-004	3.4800e-003	9.6000e-003	3.0000e-005	2.8000e-003	3.0000e-005	2.8200e-003	7.5000e-004	3.0000e-005	7.7000e-004		3.5208	3.5208	1.8000e-004		3.5253
<b>Total</b>	<b>0.0185</b>	<b>3.4900e-003</b>	<b>0.0112</b>	<b>3.0000e-005</b>	<b>2.8000e-003</b>	<b>4.0000e-005</b>	<b>2.8300e-003</b>	<b>7.5000e-004</b>	<b>4.0000e-005</b>	<b>7.8000e-004</b>		<b>3.5243</b>	<b>3.5243</b>	<b>1.9000e-004</b>	<b>0.0000</b>	<b>3.5290</b>

**Mitigated Operational**

	ROG	NOx	CO	SO2	Fugitive PM10	Exhaust PM10	PM10 Total	Fugitive PM2.5	Exhaust PM2.5	PM2.5 Total	Bio- CO2	NBio- CO2	Total CO2	CH4	N2O	CO2e
Category	lb/day										lb/day					
Area	0.0178	1.0000e-005	1.6400e-003	0.0000		1.0000e-005	1.0000e-005		1.0000e-005	1.0000e-005		3.5000e-003	3.5000e-003	1.0000e-005		3.7300e-003
Energy	0.0000	0.0000	0.0000	0.0000		0.0000	0.0000		0.0000	0.0000		0.0000	0.0000	0.0000	0.0000	0.0000
Mobile	7.4000e-004	3.4800e-003	9.6000e-003	3.0000e-005	2.8000e-003	3.0000e-005	2.8200e-003	7.5000e-004	3.0000e-005	7.7000e-004		3.5208	3.5208	1.8000e-004		3.5253
<b>Total</b>	<b>0.0185</b>	<b>3.4900e-003</b>	<b>0.0112</b>	<b>3.0000e-005</b>	<b>2.8000e-003</b>	<b>4.0000e-005</b>	<b>2.8300e-003</b>	<b>7.5000e-004</b>	<b>4.0000e-005</b>	<b>7.8000e-004</b>		<b>3.5243</b>	<b>3.5243</b>	<b>1.9000e-004</b>	<b>0.0000</b>	<b>3.5290</b>

TVMWD Production Well - Los Angeles-South Coast County, Summer

	ROG	NOx	CO	SO2	Fugitive PM10	Exhaust PM10	PM10 Total	Fugitive PM2.5	Exhaust PM2.5	PM2.5 Total	Bio- CO2	NBio-CO2	Total CO2	CH4	N2O	CO2e
Percent Reduction	0.00	0.00	0.00	0.00	0.00	0.00	0.00	0.00	0.00	0.00	0.00	0.00	0.00	0.00	0.00	0.00

**3.0 Construction Detail**

**Construction Phase**

Phase Number	Phase Name	Phase Type	Start Date	End Date	Num Days Week	Num Days	Phase Description
1	Site Preparation	Site Preparation	11/15/2019	11/15/2019	5	1	
2	Grading	Grading	11/16/2019	11/19/2019	5	2	
3	Building Construction	Building Construction	11/20/2019	2/7/2020	5	58	
4	Paving	Paving	2/8/2020	2/14/2020	5	5	
5	Architectural Coating	Architectural Coating	2/15/2020	2/21/2020	5	5	

Acres of Grading (Site Preparation Phase): 0.38

Acres of Grading (Grading Phase): 0.5

Acres of Paving: 0.34

Residential Indoor: 0; Residential Outdoor: 0; Non-Residential Indoor: 750; Non-Residential Outdoor: 250; Striped Parking Area: 900 (Architectural Coating – sqft)

**OffRoad Equipment**

Phase Name	Offroad Equipment Type	Amount	Usage Hours	Horse Power	Load Factor
Site Preparation	Graders	1	6.00	187	0.41
Site Preparation	Other Material Handling Equipment	1	8.00	168	0.40
Site Preparation	Rubber Tired Dozers	1	4.00	247	0.40
Site Preparation	Tractors/Loaders/Backhoes	1	6.00	97	0.37
Grading	Concrete/Industrial Saws	1	8.00	81	0.73

TVMWD Production Well - Los Angeles-South Coast County, Summer

Grading	Graders	1	4.00	187	0.41
Grading	Other Material Handling Equipment	1	4.00	168	0.40
Grading	Rubber Tired Dozers	1	4.00	247	0.40
Grading	Tractors/Loaders/Backhoes	1	4.00	97	0.37
Building Construction	Bore/Drill Rigs	1	24.00	221	0.50
Building Construction	Cranes	1	4.00	231	0.29
Building Construction	Forklifts	2	6.00	89	0.20
Building Construction	Generator Sets	1	24.00	84	0.74
Building Construction	Other Construction Equipment	1	8.00	172	0.42
Building Construction	Rubber Tired Dozers	1	4.00	247	0.40
Building Construction	Tractors/Loaders/Backhoes	2	8.00	97	0.37
Building Construction	Welders	1	4.00	46	0.45
Paving	Cement and Mortar Mixers	1	6.00	9	0.56
Paving	Concrete/Industrial Saws	1	8.00	81	0.73
Paving	Dumpers/Tenders	1	4.00	16	0.38
Paving	Graders	1	8.00	187	0.41
Paving	Pavers	1	7.00	130	0.42
Paving	Paving Equipment	1	8.00	172	0.42
Paving	Rollers	1	7.00	80	0.38
Paving	Rubber Tired Dozers	0		247	0.40
Paving	Tractors/Loaders/Backhoes	1	7.00	97	0.37
Paving	Welders	0		46	0.45
Architectural Coating	Air Compressors	1	6.00	78	0.48

**Trips and VMT**

TVMWD Production Well - Los Angeles-South Coast County, Summer

Phase Name	Offroad Equipment Count	Worker Trip Number	Vendor Trip Number	Hauling Trip Number	Worker Trip Length	Vendor Trip Length	Hauling Trip Length	Worker Vehicle Class	Vendor Vehicle Class	Hauling Vehicle Class
Site Preparation	4	10.00	0.00	0.00	14.70	6.90	20.00	LD_Mix	HDT_Mix	HHDT
Grading	5	10.00	0.00	0.00	14.70	6.90	20.00	LD_Mix	HDT_Mix	HHDT
Building Construction	10	7.00	3.00	0.00	14.70	6.90	20.00	LD_Mix	HDT_Mix	HHDT
Paving	8	15.00	0.00	0.00	14.70	6.90	20.00	LD_Mix	HDT_Mix	HHDT
Architectural Coating	1	1.00	0.00	0.00	14.70	6.90	20.00	LD_Mix	HDT_Mix	HHDT

3.1 Mitigation Measures Construction

Water Exposed Area

3.2 Site Preparation - 2019

Unmitigated Construction On-Site

	ROG	NOx	CO	SO2	Fugitive PM10	Exhaust PM10	PM10 Total	Fugitive PM2.5	Exhaust PM2.5	PM2.5 Total	Bio- CO2	NBio- CO2	Total CO2	CH4	N2O	CO2e
Category	lb/day										lb/day					
Fugitive Dust					3.4140	0.0000	3.4140	1.6986	0.0000	1.6986			0.0000			0.0000
Off-Road	1.4383	16.0123	9.0227	0.0174		0.7343	0.7343		0.6755	0.6755		1,718.7050	1,718.7050	0.5438		1,732.2995
<b>Total</b>	<b>1.4383</b>	<b>16.0123</b>	<b>9.0227</b>	<b>0.0174</b>	<b>3.4140</b>	<b>0.7343</b>	<b>4.1483</b>	<b>1.6986</b>	<b>0.6755</b>	<b>2.3742</b>		<b>1,718.7050</b>	<b>1,718.7050</b>	<b>0.5438</b>		<b>1,732.2995</b>

TVMWD Production Well - Los Angeles-South Coast County, Summer

**3.2 Site Preparation - 2019**

**Unmitigated Construction Off-Site**

	ROG	NOx	CO	SO2	Fugitive PM10	Exhaust PM10	PM10 Total	Fugitive PM2.5	Exhaust PM2.5	PM2.5 Total	Bio- CO2	NBio- CO2	Total CO2	CH4	N2O	CO2e
Category	lb/day										lb/day					
Hauling	0.0000	0.0000	0.0000	0.0000	0.0000	0.0000	0.0000	0.0000	0.0000	0.0000		0.0000	0.0000	0.0000		0.0000
Vendor	0.0000	0.0000	0.0000	0.0000	0.0000	0.0000	0.0000	0.0000	0.0000	0.0000		0.0000	0.0000	0.0000		0.0000
Worker	0.0500	0.0367	0.4822	1.2200e-003	0.1118	9.6000e-004	0.1127	0.0296	8.9000e-004	0.0305		121.2953	121.2953	4.1700e-003		121.3995
<b>Total</b>	<b>0.0500</b>	<b>0.0367</b>	<b>0.4822</b>	<b>1.2200e-003</b>	<b>0.1118</b>	<b>9.6000e-004</b>	<b>0.1127</b>	<b>0.0296</b>	<b>8.9000e-004</b>	<b>0.0305</b>		<b>121.2953</b>	<b>121.2953</b>	<b>4.1700e-003</b>		<b>121.3995</b>

**Mitigated Construction On-Site**

	ROG	NOx	CO	SO2	Fugitive PM10	Exhaust PM10	PM10 Total	Fugitive PM2.5	Exhaust PM2.5	PM2.5 Total	Bio- CO2	NBio- CO2	Total CO2	CH4	N2O	CO2e
Category	lb/day										lb/day					
Fugitive Dust					1.5363	0.0000	1.5363	0.7644	0.0000	0.7644			0.0000			0.0000
Off-Road	1.4383	16.0123	9.0227	0.0174		0.7343	0.7343		0.6755	0.6755	0.0000	1,718.7050	1,718.7050	0.5438		1,732.2995
<b>Total</b>	<b>1.4383</b>	<b>16.0123</b>	<b>9.0227</b>	<b>0.0174</b>	<b>1.5363</b>	<b>0.7343</b>	<b>2.2706</b>	<b>0.7644</b>	<b>0.6755</b>	<b>1.4399</b>	<b>0.0000</b>	<b>1,718.7050</b>	<b>1,718.7050</b>	<b>0.5438</b>		<b>1,732.2995</b>

TVMWD Production Well - Los Angeles-South Coast County, Summer

**3.2 Site Preparation - 2019**

**Mitigated Construction Off-Site**

	ROG	NOx	CO	SO2	Fugitive PM10	Exhaust PM10	PM10 Total	Fugitive PM2.5	Exhaust PM2.5	PM2.5 Total	Bio- CO2	NBio- CO2	Total CO2	CH4	N2O	CO2e
Category	lb/day										lb/day					
Hauling	0.0000	0.0000	0.0000	0.0000	0.0000	0.0000	0.0000	0.0000	0.0000	0.0000		0.0000	0.0000	0.0000		0.0000
Vendor	0.0000	0.0000	0.0000	0.0000	0.0000	0.0000	0.0000	0.0000	0.0000	0.0000		0.0000	0.0000	0.0000		0.0000
Worker	0.0500	0.0367	0.4822	1.2200e-003	0.1118	9.6000e-004	0.1127	0.0296	8.9000e-004	0.0305		121.2953	121.2953	4.1700e-003		121.3995
<b>Total</b>	<b>0.0500</b>	<b>0.0367</b>	<b>0.4822</b>	<b>1.2200e-003</b>	<b>0.1118</b>	<b>9.6000e-004</b>	<b>0.1127</b>	<b>0.0296</b>	<b>8.9000e-004</b>	<b>0.0305</b>		<b>121.2953</b>	<b>121.2953</b>	<b>4.1700e-003</b>		<b>121.3995</b>

**3.3 Grading - 2019**

**Unmitigated Construction On-Site**

	ROG	NOx	CO	SO2	Fugitive PM10	Exhaust PM10	PM10 Total	Fugitive PM2.5	Exhaust PM2.5	PM2.5 Total	Bio- CO2	NBio- CO2	Total CO2	CH4	N2O	CO2e
Category	lb/day										lb/day					
Fugitive Dust					3.2762	0.0000	3.2762	1.6837	0.0000	1.6837			0.0000			0.0000
Off-Road	1.5548	15.7279	9.8022	0.0183		0.7897	0.7897		0.7448	0.7448		1,784.0214	1,784.0214	0.4187		1,794.4876
<b>Total</b>	<b>1.5548</b>	<b>15.7279</b>	<b>9.8022</b>	<b>0.0183</b>	<b>3.2762</b>	<b>0.7897</b>	<b>4.0658</b>	<b>1.6837</b>	<b>0.7448</b>	<b>2.4286</b>		<b>1,784.0214</b>	<b>1,784.0214</b>	<b>0.4187</b>		<b>1,794.4876</b>

TVMWD Production Well - Los Angeles-South Coast County, Summer

**3.3 Grading - 2019**

**Unmitigated Construction Off-Site**

	ROG	NOx	CO	SO2	Fugitive PM10	Exhaust PM10	PM10 Total	Fugitive PM2.5	Exhaust PM2.5	PM2.5 Total	Bio- CO2	NBio- CO2	Total CO2	CH4	N2O	CO2e
Category	lb/day										lb/day					
Hauling	0.0000	0.0000	0.0000	0.0000	0.0000	0.0000	0.0000	0.0000	0.0000	0.0000		0.0000	0.0000	0.0000		0.0000
Vendor	0.0000	0.0000	0.0000	0.0000	0.0000	0.0000	0.0000	0.0000	0.0000	0.0000		0.0000	0.0000	0.0000		0.0000
Worker	0.0500	0.0367	0.4822	1.2200e-003	0.1118	9.6000e-004	0.1127	0.0296	8.9000e-004	0.0305		121.2953	121.2953	4.1700e-003		121.3995
<b>Total</b>	<b>0.0500</b>	<b>0.0367</b>	<b>0.4822</b>	<b>1.2200e-003</b>	<b>0.1118</b>	<b>9.6000e-004</b>	<b>0.1127</b>	<b>0.0296</b>	<b>8.9000e-004</b>	<b>0.0305</b>		<b>121.2953</b>	<b>121.2953</b>	<b>4.1700e-003</b>		<b>121.3995</b>

**Mitigated Construction On-Site**

	ROG	NOx	CO	SO2	Fugitive PM10	Exhaust PM10	PM10 Total	Fugitive PM2.5	Exhaust PM2.5	PM2.5 Total	Bio- CO2	NBio- CO2	Total CO2	CH4	N2O	CO2e
Category	lb/day										lb/day					
Fugitive Dust					1.4743	0.0000	1.4743	0.7577	0.0000	0.7577			0.0000			0.0000
Off-Road	1.5548	15.7279	9.8022	0.0183		0.7897	0.7897		0.7448	0.7448	0.0000	1,784.0214	1,784.0214	0.4187		1,794.4876
<b>Total</b>	<b>1.5548</b>	<b>15.7279</b>	<b>9.8022</b>	<b>0.0183</b>	<b>1.4743</b>	<b>0.7897</b>	<b>2.2639</b>	<b>0.7577</b>	<b>0.7448</b>	<b>1.5025</b>	<b>0.0000</b>	<b>1,784.0214</b>	<b>1,784.0214</b>	<b>0.4187</b>		<b>1,794.4876</b>

TVMWD Production Well - Los Angeles-South Coast County, Summer

**3.3 Grading - 2019**

**Mitigated Construction Off-Site**

	ROG	NOx	CO	SO2	Fugitive PM10	Exhaust PM10	PM10 Total	Fugitive PM2.5	Exhaust PM2.5	PM2.5 Total	Bio- CO2	NBio- CO2	Total CO2	CH4	N2O	CO2e
Category	lb/day										lb/day					
Hauling	0.0000	0.0000	0.0000	0.0000	0.0000	0.0000	0.0000	0.0000	0.0000	0.0000		0.0000	0.0000	0.0000		0.0000
Vendor	0.0000	0.0000	0.0000	0.0000	0.0000	0.0000	0.0000	0.0000	0.0000	0.0000		0.0000	0.0000	0.0000		0.0000
Worker	0.0500	0.0367	0.4822	1.2200e-003	0.1118	9.6000e-004	0.1127	0.0296	8.9000e-004	0.0305		121.2953	121.2953	4.1700e-003		121.3995
<b>Total</b>	<b>0.0500</b>	<b>0.0367</b>	<b>0.4822</b>	<b>1.2200e-003</b>	<b>0.1118</b>	<b>9.6000e-004</b>	<b>0.1127</b>	<b>0.0296</b>	<b>8.9000e-004</b>	<b>0.0305</b>		<b>121.2953</b>	<b>121.2953</b>	<b>4.1700e-003</b>		<b>121.3995</b>

**3.4 Building Construction - 2019**

**Unmitigated Construction On-Site**

	ROG	NOx	CO	SO2	Fugitive PM10	Exhaust PM10	PM10 Total	Fugitive PM2.5	Exhaust PM2.5	PM2.5 Total	Bio- CO2	NBio- CO2	Total CO2	CH4	N2O	CO2e
Category	lb/day										lb/day					
Off-Road	4.4127	44.7273	32.1076	0.0710		2.2386	2.2386		2.1177	2.1177		6,917.1477	6,917.1477	1.7001		6,959.6494
<b>Total</b>	<b>4.4127</b>	<b>44.7273</b>	<b>32.1076</b>	<b>0.0710</b>		<b>2.2386</b>	<b>2.2386</b>		<b>2.1177</b>	<b>2.1177</b>		<b>6,917.1477</b>	<b>6,917.1477</b>	<b>1.7001</b>		<b>6,959.6494</b>



TVMWD Production Well - Los Angeles-South Coast County, Summer

**3.4 Building Construction - 2019**

**Unmitigated Construction Off-Site**

	ROG	NOx	CO	SO2	Fugitive PM10	Exhaust PM10	PM10 Total	Fugitive PM2.5	Exhaust PM2.5	PM2.5 Total	Bio- CO2	NBio- CO2	Total CO2	CH4	N2O	CO2e
Category	lb/day										lb/day					
Hauling	0.0000	0.0000	0.0000	0.0000	0.0000	0.0000	0.0000	0.0000	0.0000	0.0000		0.0000	0.0000	0.0000		0.0000
Vendor	0.0125	0.3472	0.0921	7.8000e-004	0.0192	2.2100e-003	0.0214	5.5300e-003	2.1200e-003	7.6500e-003		83.6444	83.6444	5.3600e-003		83.7784
Worker	0.0350	0.0257	0.3375	8.5000e-004	0.0782	6.7000e-004	0.0789	0.0208	6.2000e-004	0.0214		84.9067	84.9067	2.9200e-003		84.9796
<b>Total</b>	<b>0.0474</b>	<b>0.3729</b>	<b>0.4296</b>	<b>1.6300e-003</b>	<b>0.0975</b>	<b>2.8800e-003</b>	<b>0.1003</b>	<b>0.0263</b>	<b>2.7400e-003</b>	<b>0.0290</b>		<b>168.5511</b>	<b>168.5511</b>	<b>8.2800e-003</b>		<b>168.7580</b>

**Mitigated Construction On-Site**

	ROG	NOx	CO	SO2	Fugitive PM10	Exhaust PM10	PM10 Total	Fugitive PM2.5	Exhaust PM2.5	PM2.5 Total	Bio- CO2	NBio- CO2	Total CO2	CH4	N2O	CO2e
Category	lb/day										lb/day					
Off-Road	4.4127	44.7273	32.1076	0.0710		2.2386	2.2386		2.1177	2.1177	0.0000	6,917.1477	6,917.1477	1.7001		6,959.6494
<b>Total</b>	<b>4.4127</b>	<b>44.7273</b>	<b>32.1076</b>	<b>0.0710</b>		<b>2.2386</b>	<b>2.2386</b>		<b>2.1177</b>	<b>2.1177</b>	<b>0.0000</b>	<b>6,917.1477</b>	<b>6,917.1477</b>	<b>1.7001</b>		<b>6,959.6494</b>

TVMWD Production Well - Los Angeles-South Coast County, Summer

**3.4 Building Construction - 2019**

**Mitigated Construction Off-Site**

	ROG	NOx	CO	SO2	Fugitive PM10	Exhaust PM10	PM10 Total	Fugitive PM2.5	Exhaust PM2.5	PM2.5 Total	Bio- CO2	NBio- CO2	Total CO2	CH4	N2O	CO2e
Category	lb/day										lb/day					
Hauling	0.0000	0.0000	0.0000	0.0000	0.0000	0.0000	0.0000	0.0000	0.0000	0.0000		0.0000	0.0000	0.0000		0.0000
Vendor	0.0125	0.3472	0.0921	7.8000e-004	0.0192	2.2100e-003	0.0214	5.5300e-003	2.1200e-003	7.6500e-003		83.6444	83.6444	5.3600e-003		83.7784
Worker	0.0350	0.0257	0.3375	8.5000e-004	0.0782	6.7000e-004	0.0789	0.0208	6.2000e-004	0.0214		84.9067	84.9067	2.9200e-003		84.9796
<b>Total</b>	<b>0.0474</b>	<b>0.3729</b>	<b>0.4296</b>	<b>1.6300e-003</b>	<b>0.0975</b>	<b>2.8800e-003</b>	<b>0.1003</b>	<b>0.0263</b>	<b>2.7400e-003</b>	<b>0.0290</b>		<b>168.5511</b>	<b>168.5511</b>	<b>8.2800e-003</b>		<b>168.7580</b>

**3.4 Building Construction - 2020**

**Unmitigated Construction On-Site**

	ROG	NOx	CO	SO2	Fugitive PM10	Exhaust PM10	PM10 Total	Fugitive PM2.5	Exhaust PM2.5	PM2.5 Total	Bio- CO2	NBio- CO2	Total CO2	CH4	N2O	CO2e
Category	lb/day										lb/day					
Off-Road	4.0962	41.5458	31.8177	0.0711		2.0129	2.0129		1.9025	1.9025		6,817.7166	6,817.7166	1.6875		6,859.9044
<b>Total</b>	<b>4.0962</b>	<b>41.5458</b>	<b>31.8177</b>	<b>0.0711</b>		<b>2.0129</b>	<b>2.0129</b>		<b>1.9025</b>	<b>1.9025</b>		<b>6,817.7166</b>	<b>6,817.7166</b>	<b>1.6875</b>		<b>6,859.9044</b>

TVMWD Production Well - Los Angeles-South Coast County, Summer

**3.4 Building Construction - 2020**

**Unmitigated Construction Off-Site**

	ROG	NOx	CO	SO2	Fugitive PM10	Exhaust PM10	PM10 Total	Fugitive PM2.5	Exhaust PM2.5	PM2.5 Total	Bio- CO2	NBio- CO2	Total CO2	CH4	N2O	CO2e
Category	lb/day										lb/day					
Hauling	0.0000	0.0000	0.0000	0.0000	0.0000	0.0000	0.0000	0.0000	0.0000	0.0000		0.0000	0.0000	0.0000		0.0000
Vendor	0.0107	0.3191	0.0836	7.8000e-004	0.0192	1.5000e-003	0.0207	5.5300e-003	1.4400e-003	6.9700e-003		83.1074	83.1074	5.0700e-003		83.2342
Worker	0.0322	0.0229	0.3065	8.3000e-004	0.0782	6.5000e-004	0.0789	0.0208	6.0000e-004	0.0214		82.3279	82.3279	2.6000e-003		82.3928
<b>Total</b>	<b>0.0429</b>	<b>0.3420</b>	<b>0.3901</b>	<b>1.6100e-003</b>	<b>0.0975</b>	<b>2.1500e-003</b>	<b>0.0996</b>	<b>0.0263</b>	<b>2.0400e-003</b>	<b>0.0283</b>		<b>165.4353</b>	<b>165.4353</b>	<b>7.6700e-003</b>		<b>165.6270</b>

**Mitigated Construction On-Site**

	ROG	NOx	CO	SO2	Fugitive PM10	Exhaust PM10	PM10 Total	Fugitive PM2.5	Exhaust PM2.5	PM2.5 Total	Bio- CO2	NBio- CO2	Total CO2	CH4	N2O	CO2e
Category	lb/day										lb/day					
Off-Road	4.0962	41.5458	31.8177	0.0711		2.0129	2.0129		1.9025	1.9025	0.0000	6,817.7166	6,817.7166	1.6875		6,859.9044
<b>Total</b>	<b>4.0962</b>	<b>41.5458</b>	<b>31.8177</b>	<b>0.0711</b>		<b>2.0129</b>	<b>2.0129</b>		<b>1.9025</b>	<b>1.9025</b>	<b>0.0000</b>	<b>6,817.7166</b>	<b>6,817.7166</b>	<b>1.6875</b>		<b>6,859.9044</b>

TVMWD Production Well - Los Angeles-South Coast County, Summer

**3.4 Building Construction - 2020**

**Mitigated Construction Off-Site**

	ROG	NOx	CO	SO2	Fugitive PM10	Exhaust PM10	PM10 Total	Fugitive PM2.5	Exhaust PM2.5	PM2.5 Total	Bio- CO2	NBio- CO2	Total CO2	CH4	N2O	CO2e
Category	lb/day										lb/day					
Hauling	0.0000	0.0000	0.0000	0.0000	0.0000	0.0000	0.0000	0.0000	0.0000	0.0000		0.0000	0.0000	0.0000		0.0000
Vendor	0.0107	0.3191	0.0836	7.8000e-004	0.0192	1.5000e-003	0.0207	5.5300e-003	1.4400e-003	6.9700e-003		83.1074	83.1074	5.0700e-003		83.2342
Worker	0.0322	0.0229	0.3065	8.3000e-004	0.0782	6.5000e-004	0.0789	0.0208	6.0000e-004	0.0214		82.3279	82.3279	2.6000e-003		82.3928
<b>Total</b>	<b>0.0429</b>	<b>0.3420</b>	<b>0.3901</b>	<b>1.6100e-003</b>	<b>0.0975</b>	<b>2.1500e-003</b>	<b>0.0996</b>	<b>0.0263</b>	<b>2.0400e-003</b>	<b>0.0283</b>		<b>165.4353</b>	<b>165.4353</b>	<b>7.6700e-003</b>		<b>165.6270</b>

**3.5 Paving - 2020**

**Unmitigated Construction On-Site**

	ROG	NOx	CO	SO2	Fugitive PM10	Exhaust PM10	PM10 Total	Fugitive PM2.5	Exhaust PM2.5	PM2.5 Total	Bio- CO2	NBio- CO2	Total CO2	CH4	N2O	CO2e
Category	lb/day										lb/day					
Off-Road	1.8855	19.5101	15.8980	0.0291		0.9349	0.9349		0.8775	0.8775		2,787.3469	2,787.3469	0.7324		2,805.6580
Paving	0.1205					0.0000	0.0000		0.0000	0.0000			0.0000			0.0000
<b>Total</b>	<b>2.0060</b>	<b>19.5101</b>	<b>15.8980</b>	<b>0.0291</b>		<b>0.9349</b>	<b>0.9349</b>		<b>0.8775</b>	<b>0.8775</b>		<b>2,787.3469</b>	<b>2,787.3469</b>	<b>0.7324</b>		<b>2,805.6580</b>

TVMWD Production Well - Los Angeles-South Coast County, Summer

**3.5 Paving - 2020**

**Unmitigated Construction Off-Site**

	ROG	NOx	CO	SO2	Fugitive PM10	Exhaust PM10	PM10 Total	Fugitive PM2.5	Exhaust PM2.5	PM2.5 Total	Bio- CO2	NBio- CO2	Total CO2	CH4	N2O	CO2e
Category	lb/day										lb/day					
Hauling	0.0000	0.0000	0.0000	0.0000	0.0000	0.0000	0.0000	0.0000	0.0000	0.0000		0.0000	0.0000	0.0000		0.0000
Vendor	0.0000	0.0000	0.0000	0.0000	0.0000	0.0000	0.0000	0.0000	0.0000	0.0000		0.0000	0.0000	0.0000		0.0000
Worker	0.0690	0.0491	0.6568	1.7700e-003	0.1677	1.4000e-003	0.1691	0.0445	1.2900e-003	0.0458		176.4169	176.4169	5.5600e-003		176.5560
<b>Total</b>	<b>0.0690</b>	<b>0.0491</b>	<b>0.6568</b>	<b>1.7700e-003</b>	<b>0.1677</b>	<b>1.4000e-003</b>	<b>0.1691</b>	<b>0.0445</b>	<b>1.2900e-003</b>	<b>0.0458</b>		<b>176.4169</b>	<b>176.4169</b>	<b>5.5600e-003</b>		<b>176.5560</b>

**Mitigated Construction On-Site**

	ROG	NOx	CO	SO2	Fugitive PM10	Exhaust PM10	PM10 Total	Fugitive PM2.5	Exhaust PM2.5	PM2.5 Total	Bio- CO2	NBio- CO2	Total CO2	CH4	N2O	CO2e
Category	lb/day										lb/day					
Off-Road	1.8855	19.5101	15.8980	0.0291		0.9349	0.9349		0.8775	0.8775	0.0000	2,787.3469	2,787.3469	0.7324		2,805.6580
Paving	0.1205					0.0000	0.0000		0.0000	0.0000			0.0000			0.0000
<b>Total</b>	<b>2.0060</b>	<b>19.5101</b>	<b>15.8980</b>	<b>0.0291</b>		<b>0.9349</b>	<b>0.9349</b>		<b>0.8775</b>	<b>0.8775</b>	<b>0.0000</b>	<b>2,787.3469</b>	<b>2,787.3469</b>	<b>0.7324</b>		<b>2,805.6580</b>

TVMWD Production Well - Los Angeles-South Coast County, Summer

**3.5 Paving - 2020**

**Mitigated Construction Off-Site**

	ROG	NOx	CO	SO2	Fugitive PM10	Exhaust PM10	PM10 Total	Fugitive PM2.5	Exhaust PM2.5	PM2.5 Total	Bio- CO2	NBio- CO2	Total CO2	CH4	N2O	CO2e
Category	lb/day										lb/day					
Hauling	0.0000	0.0000	0.0000	0.0000	0.0000	0.0000	0.0000	0.0000	0.0000	0.0000		0.0000	0.0000	0.0000		0.0000
Vendor	0.0000	0.0000	0.0000	0.0000	0.0000	0.0000	0.0000	0.0000	0.0000	0.0000		0.0000	0.0000	0.0000		0.0000
Worker	0.0690	0.0491	0.6568	1.7700e-003	0.1677	1.4000e-003	0.1691	0.0445	1.2900e-003	0.0458		176.4169	176.4169	5.5600e-003		176.5560
<b>Total</b>	<b>0.0690</b>	<b>0.0491</b>	<b>0.6568</b>	<b>1.7700e-003</b>	<b>0.1677</b>	<b>1.4000e-003</b>	<b>0.1691</b>	<b>0.0445</b>	<b>1.2900e-003</b>	<b>0.0458</b>		<b>176.4169</b>	<b>176.4169</b>	<b>5.5600e-003</b>		<b>176.5560</b>

**3.6 Architectural Coating - 2020**

**Unmitigated Construction On-Site**

	ROG	NOx	CO	SO2	Fugitive PM10	Exhaust PM10	PM10 Total	Fugitive PM2.5	Exhaust PM2.5	PM2.5 Total	Bio- CO2	NBio- CO2	Total CO2	CH4	N2O	CO2e
Category	lb/day										lb/day					
Archit. Coating	1.7613					0.0000	0.0000		0.0000	0.0000			0.0000			0.0000
Off-Road	0.2422	1.6838	1.8314	2.9700e-003		0.1109	0.1109		0.1109	0.1109		281.4481	281.4481	0.0218		281.9928
<b>Total</b>	<b>2.0035</b>	<b>1.6838</b>	<b>1.8314</b>	<b>2.9700e-003</b>		<b>0.1109</b>	<b>0.1109</b>		<b>0.1109</b>	<b>0.1109</b>		<b>281.4481</b>	<b>281.4481</b>	<b>0.0218</b>		<b>281.9928</b>

TVMWD Production Well - Los Angeles-South Coast County, Summer

**3.6 Architectural Coating - 2020**

**Unmitigated Construction Off-Site**

	ROG	NOx	CO	SO2	Fugitive PM10	Exhaust PM10	PM10 Total	Fugitive PM2.5	Exhaust PM2.5	PM2.5 Total	Bio- CO2	NBio- CO2	Total CO2	CH4	N2O	CO2e
Category	lb/day										lb/day					
Hauling	0.0000	0.0000	0.0000	0.0000	0.0000	0.0000	0.0000	0.0000	0.0000	0.0000		0.0000	0.0000	0.0000		0.0000
Vendor	0.0000	0.0000	0.0000	0.0000	0.0000	0.0000	0.0000	0.0000	0.0000	0.0000		0.0000	0.0000	0.0000		0.0000
Worker	4.6000e-003	3.2700e-003	0.0438	1.2000e-004	0.0112	9.0000e-005	0.0113	2.9600e-003	9.0000e-005	3.0500e-003		11.7611	11.7611	3.7000e-004		11.7704
<b>Total</b>	<b>4.6000e-003</b>	<b>3.2700e-003</b>	<b>0.0438</b>	<b>1.2000e-004</b>	<b>0.0112</b>	<b>9.0000e-005</b>	<b>0.0113</b>	<b>2.9600e-003</b>	<b>9.0000e-005</b>	<b>3.0500e-003</b>		<b>11.7611</b>	<b>11.7611</b>	<b>3.7000e-004</b>		<b>11.7704</b>

**Mitigated Construction On-Site**

	ROG	NOx	CO	SO2	Fugitive PM10	Exhaust PM10	PM10 Total	Fugitive PM2.5	Exhaust PM2.5	PM2.5 Total	Bio- CO2	NBio- CO2	Total CO2	CH4	N2O	CO2e
Category	lb/day										lb/day					
Archit. Coating	1.7613					0.0000	0.0000		0.0000	0.0000			0.0000			0.0000
Off-Road	0.2422	1.6838	1.8314	2.9700e-003		0.1109	0.1109		0.1109	0.1109	0.0000	281.4481	281.4481	0.0218		281.9928
<b>Total</b>	<b>2.0035</b>	<b>1.6838</b>	<b>1.8314</b>	<b>2.9700e-003</b>		<b>0.1109</b>	<b>0.1109</b>		<b>0.1109</b>	<b>0.1109</b>	<b>0.0000</b>	<b>281.4481</b>	<b>281.4481</b>	<b>0.0218</b>		<b>281.9928</b>

TVMWD Production Well - Los Angeles-South Coast County, Summer

**3.6 Architectural Coating - 2020**

**Mitigated Construction Off-Site**

	ROG	NOx	CO	SO2	Fugitive PM10	Exhaust PM10	PM10 Total	Fugitive PM2.5	Exhaust PM2.5	PM2.5 Total	Bio- CO2	NBio- CO2	Total CO2	CH4	N2O	CO2e
Category	lb/day										lb/day					
Hauling	0.0000	0.0000	0.0000	0.0000	0.0000	0.0000	0.0000	0.0000	0.0000	0.0000		0.0000	0.0000	0.0000		0.0000
Vendor	0.0000	0.0000	0.0000	0.0000	0.0000	0.0000	0.0000	0.0000	0.0000	0.0000		0.0000	0.0000	0.0000		0.0000
Worker	4.6000e-003	3.2700e-003	0.0438	1.2000e-004	0.0112	9.0000e-005	0.0113	2.9600e-003	9.0000e-005	3.0500e-003		11.7611	11.7611	3.7000e-004		11.7704
<b>Total</b>	<b>4.6000e-003</b>	<b>3.2700e-003</b>	<b>0.0438</b>	<b>1.2000e-004</b>	<b>0.0112</b>	<b>9.0000e-005</b>	<b>0.0113</b>	<b>2.9600e-003</b>	<b>9.0000e-005</b>	<b>3.0500e-003</b>		<b>11.7611</b>	<b>11.7611</b>	<b>3.7000e-004</b>		<b>11.7704</b>

**4.0 Operational Detail - Mobile**

---

**4.1 Mitigation Measures Mobile**



TVMWD Production Well - Los Angeles-South Coast County, Summer

	ROG	NOx	CO	SO2	Fugitive PM10	Exhaust PM10	PM10 Total	Fugitive PM2.5	Exhaust PM2.5	PM2.5 Total	Bio- CO2	NBio- CO2	Total CO2	CH4	N2O	CO2e
Category	lb/day										lb/day					
Mitigated	7.4000e-004	3.4800e-003	9.6000e-003	3.0000e-005	2.8000e-003	3.0000e-005	2.8200e-003	7.5000e-004	3.0000e-005	7.7000e-004		3.5208	3.5208	1.8000e-004		3.5253
Unmitigated	7.4000e-004	3.4800e-003	9.6000e-003	3.0000e-005	2.8000e-003	3.0000e-005	2.8200e-003	7.5000e-004	3.0000e-005	7.7000e-004		3.5208	3.5208	1.8000e-004		3.5253

4.2 Trip Summary Information

Land Use	Average Daily Trip Rate			Unmitigated	Mitigated
	Weekday	Saturday	Sunday	Annual VMT	Annual VMT
Other Non-Asphalt Surfaces	0.00	0.00	0.00		
Parking Lot	0.00	0.00	0.00		
User Defined Industrial	0.43	0.00	0.00	939	939
Total	0.43	0.00	0.00	939	939

4.3 Trip Type Information

Land Use	Miles			Trip %			Trip Purpose %		
	H-W or C-W	H-S or C-C	H-O or C-NW	H-W or C-W	H-S or C-C	H-O or C-NW	Primary	Diverted	Pass-by
Other Non-Asphalt Surfaces	16.60	8.40	6.90	0.00	0.00	0.00	0	0	0
Parking Lot	16.60	8.40	6.90	0.00	0.00	0.00	0	0	0
User Defined Industrial	16.60	8.40	6.90	0.00	100.00	0.00	100	0	0

4.4 Fleet Mix

TVMWD Production Well - Los Angeles-South Coast County, Summer

Land Use	LDA	LDT1	LDT2	MDV	LHD1	LHD2	MHD	HHD	OBUS	UBUS	MCY	SBUS	MH
Other Non-Asphalt Surfaces	0.546501	0.044961	0.204016	0.120355	0.015740	0.006196	0.020131	0.030678	0.002515	0.002201	0.005142	0.000687	0.000876
Parking Lot	0.546501	0.044961	0.204016	0.120355	0.015740	0.006196	0.020131	0.030678	0.002515	0.002201	0.005142	0.000687	0.000876
User Defined Industrial	0.546501	0.044961	0.204016	0.120355	0.015740	0.006196	0.020131	0.030678	0.002515	0.002201	0.005142	0.000687	0.000876

5.0 Energy Detail

Historical Energy Use: N

5.1 Mitigation Measures Energy

	ROG	NOx	CO	SO2	Fugitive PM10	Exhaust PM10	PM10 Total	Fugitive PM2.5	Exhaust PM2.5	PM2.5 Total	Bio- CO2	NBio- CO2	Total CO2	CH4	N2O	CO2e
Category	lb/day										lb/day					
NaturalGas Mitigated	0.0000	0.0000	0.0000	0.0000		0.0000	0.0000		0.0000	0.0000		0.0000	0.0000	0.0000	0.0000	0.0000
NaturalGas Unmitigated	0.0000	0.0000	0.0000	0.0000		0.0000	0.0000		0.0000	0.0000		0.0000	0.0000	0.0000	0.0000	0.0000

TVMWD Production Well - Los Angeles-South Coast County, Summer

**5.2 Energy by Land Use - Natural Gas**

**Unmitigated**

	Natural Gas Use	ROG	NOx	CO	SO2	Fugitive PM10	Exhaust PM10	PM10 Total	Fugitive PM2.5	Exhaust PM2.5	PM2.5 Total	Bio- CO2	NBio- CO2	Total CO2	CH4	N2O	CO2e
Land Use	kBTU/yr	lb/day										lb/day					
Other Non-Asphalt Surfaces	0	0.0000	0.0000	0.0000	0.0000		0.0000	0.0000		0.0000	0.0000		0.0000	0.0000	0.0000	0.0000	0.0000
Parking Lot	0	0.0000	0.0000	0.0000	0.0000		0.0000	0.0000		0.0000	0.0000		0.0000	0.0000	0.0000	0.0000	0.0000
User Defined Industrial	0	0.0000	0.0000	0.0000	0.0000		0.0000	0.0000		0.0000	0.0000		0.0000	0.0000	0.0000	0.0000	0.0000
<b>Total</b>		<b>0.0000</b>	<b>0.0000</b>	<b>0.0000</b>	<b>0.0000</b>		<b>0.0000</b>	<b>0.0000</b>		<b>0.0000</b>	<b>0.0000</b>		<b>0.0000</b>	<b>0.0000</b>	<b>0.0000</b>	<b>0.0000</b>	<b>0.0000</b>

**Mitigated**

	Natural Gas Use	ROG	NOx	CO	SO2	Fugitive PM10	Exhaust PM10	PM10 Total	Fugitive PM2.5	Exhaust PM2.5	PM2.5 Total	Bio- CO2	NBio- CO2	Total CO2	CH4	N2O	CO2e
Land Use	kBTU/yr	lb/day										lb/day					
Other Non-Asphalt Surfaces	0	0.0000	0.0000	0.0000	0.0000		0.0000	0.0000		0.0000	0.0000		0.0000	0.0000	0.0000	0.0000	0.0000
Parking Lot	0	0.0000	0.0000	0.0000	0.0000		0.0000	0.0000		0.0000	0.0000		0.0000	0.0000	0.0000	0.0000	0.0000
User Defined Industrial	0	0.0000	0.0000	0.0000	0.0000		0.0000	0.0000		0.0000	0.0000		0.0000	0.0000	0.0000	0.0000	0.0000
<b>Total</b>		<b>0.0000</b>	<b>0.0000</b>	<b>0.0000</b>	<b>0.0000</b>		<b>0.0000</b>	<b>0.0000</b>		<b>0.0000</b>	<b>0.0000</b>		<b>0.0000</b>	<b>0.0000</b>	<b>0.0000</b>	<b>0.0000</b>	<b>0.0000</b>

**6.0 Area Detail**

TVMWD Production Well - Los Angeles-South Coast County, Summer

**6.1 Mitigation Measures Area**

	ROG	NOx	CO	SO2	Fugitive PM10	Exhaust PM10	PM10 Total	Fugitive PM2.5	Exhaust PM2.5	PM2.5 Total	Bio- CO2	NBio- CO2	Total CO2	CH4	N2O	CO2e
Category	lb/day										lb/day					
Mitigated	0.0178	1.0000e-005	1.6400e-003	0.0000		1.0000e-005	1.0000e-005		1.0000e-005	1.0000e-005		3.5000e-003	3.5000e-003	1.0000e-005		3.7300e-003
Unmitigated	0.0178	1.0000e-005	1.6400e-003	0.0000		1.0000e-005	1.0000e-005		1.0000e-005	1.0000e-005		3.5000e-003	3.5000e-003	1.0000e-005		3.7300e-003

**6.2 Area by SubCategory**

Unmitigated

	ROG	NOx	CO	SO2	Fugitive PM10	Exhaust PM10	PM10 Total	Fugitive PM2.5	Exhaust PM2.5	PM2.5 Total	Bio- CO2	NBio- CO2	Total CO2	CH4	N2O	CO2e
SubCategory	lb/day										lb/day					
Architectural Coating	2.4100e-003					0.0000	0.0000		0.0000	0.0000			0.0000			0.0000
Consumer Products	0.0152					0.0000	0.0000		0.0000	0.0000			0.0000			0.0000
Landscaping	1.5000e-004	1.0000e-005	1.6400e-003	0.0000		1.0000e-005	1.0000e-005		1.0000e-005	1.0000e-005		3.5000e-003	3.5000e-003	1.0000e-005		3.7300e-003
<b>Total</b>	<b>0.0178</b>	<b>1.0000e-005</b>	<b>1.6400e-003</b>	<b>0.0000</b>		<b>1.0000e-005</b>	<b>1.0000e-005</b>		<b>1.0000e-005</b>	<b>1.0000e-005</b>		<b>3.5000e-003</b>	<b>3.5000e-003</b>	<b>1.0000e-005</b>		<b>3.7300e-003</b>

TVMWD Production Well - Los Angeles-South Coast County, Summer

**6.2 Area by SubCategory**

**Mitigated**

	ROG	NOx	CO	SO2	Fugitive PM10	Exhaust PM10	PM10 Total	Fugitive PM2.5	Exhaust PM2.5	PM2.5 Total	Bio- CO2	NBio- CO2	Total CO2	CH4	N2O	CO2e
SubCategory	lb/day										lb/day					
Architectural Coating	2.4100e-003					0.0000	0.0000		0.0000	0.0000			0.0000			0.0000
Consumer Products	0.0152					0.0000	0.0000		0.0000	0.0000			0.0000			0.0000
Landscaping	1.5000e-004	1.0000e-005	1.6400e-003	0.0000		1.0000e-005	1.0000e-005		1.0000e-005	1.0000e-005		3.5000e-003	3.5000e-003	1.0000e-005		3.7300e-003
<b>Total</b>	<b>0.0178</b>	<b>1.0000e-005</b>	<b>1.6400e-003</b>	<b>0.0000</b>		<b>1.0000e-005</b>	<b>1.0000e-005</b>		<b>1.0000e-005</b>	<b>1.0000e-005</b>		<b>3.5000e-003</b>	<b>3.5000e-003</b>	<b>1.0000e-005</b>		<b>3.7300e-003</b>

**7.0 Water Detail**

---

**7.1 Mitigation Measures Water**

**8.0 Waste Detail**

---

**8.1 Mitigation Measures Waste**

**9.0 Operational Offroad**

---

Equipment Type	Number	Hours/Day	Days/Year	Horse Power	Load Factor	Fuel Type
----------------	--------	-----------	-----------	-------------	-------------	-----------

**10.0 Stationary Equipment**

---

**Fire Pumps and Emergency Generators**

TVMWD Production Well - Los Angeles-South Coast County, Summer

Equipment Type	Number	Hours/Day	Hours/Year	Horse Power	Load Factor	Fuel Type
----------------	--------	-----------	------------	-------------	-------------	-----------

**Boilers**

Equipment Type	Number	Heat Input/Day	Heat Input/Year	Boiler Rating	Fuel Type
----------------	--------	----------------	-----------------	---------------	-----------

**User Defined Equipment**

Equipment Type	Number
----------------	--------

**11.0 Vegetation**

---

TVMWD Production Well - Los Angeles-South Coast County, Winter

**TVMWD Production Well**  
**Los Angeles-South Coast County, Winter**

**1.0 Project Characteristics**

**1.1 Land Usage**

Land Uses	Size	Metric	Lot Acreage	Floor Surface Area	Population
User Defined Industrial	1.00	User Defined Unit	0.10	500.00	0
Other Non-Asphalt Surfaces	5.00	1000sqft	0.11	5,000.00	0
Parking Lot	10.00	1000sqft	0.23	10,000.00	0

**1.2 Other Project Characteristics**

<b>Urbanization</b>	Urban	<b>Wind Speed (m/s)</b>	2.2	<b>Precipitation Freq (Days)</b>	33
<b>Climate Zone</b>	10			<b>Operational Year</b>	2022
<b>Utility Company</b>	Southern California Edison				
<b>CO2 Intensity (lb/MWhr)</b>	702.44	<b>CH4 Intensity (lb/MWhr)</b>	0.029	<b>N2O Intensity (lb/MWhr)</b>	0.006

**1.3 User Entered Comments & Non-Default Data**

TVMWD Production Well - Los Angeles-South Coast County, Winter

Project Characteristics -

Land Use - Site plan

Construction Phase - Per construction contractor

Off-road Equipment - Per contractor

Off-road Equipment - Per contractor

Off-road Equipment - Per contractor

Off-road Equipment - Per contractor

Off-road Equipment - Per contractor

Demolition -

Vehicle Trips - Per applicant

Construction Off-road Equipment Mitigation -



TVMWD Production Well - Los Angeles-South Coast County, Winter

Table Name	Column Name	Default Value	New Value
tblConstructionPhase	NumDays	100.00	58.00
tblLandUse	LandUseSquareFeet	0.00	500.00
tblLandUse	LotAcreage	0.00	0.10
tblOffRoadEquipment	HorsePower	132.00	172.00
tblOffRoadEquipment	LoadFactor	0.36	0.42
tblOffRoadEquipment	OffRoadEquipmentUnitAmount	4.00	1.00
tblOffRoadEquipment	OffRoadEquipmentUnitAmount	2.00	1.00
tblOffRoadEquipment	UsageHours	8.00	6.00
tblOffRoadEquipment	UsageHours	1.00	4.00
tblOffRoadEquipment	UsageHours	6.00	4.00
tblOffRoadEquipment	UsageHours	8.00	6.00
tblTripsAndVMT	WorkerTripNumber	13.00	10.00
tblTripsAndVMT	WorkerTripNumber	20.00	15.00
tblVehicleTrips	CC_TTP	0.00	100.00
tblVehicleTrips	PR_TP	0.00	100.00
tblVehicleTrips	WD_TR	0.00	0.43

**2.0 Emissions Summary**

---



TVMWD Production Well - Los Angeles-South Coast County, Winter

**2.2 Overall Operational**

**Unmitigated Operational**

	ROG	NOx	CO	SO2	Fugitive PM10	Exhaust PM10	PM10 Total	Fugitive PM2.5	Exhaust PM2.5	PM2.5 Total	Bio- CO2	NBio- CO2	Total CO2	CH4	N2O	CO2e
Category	lb/day										lb/day					
Area	0.0178	1.0000e-005	1.6400e-003	0.0000		1.0000e-005	1.0000e-005		1.0000e-005	1.0000e-005		3.5000e-003	3.5000e-003	1.0000e-005		3.7300e-003
Energy	0.0000	0.0000	0.0000	0.0000		0.0000	0.0000		0.0000	0.0000		0.0000	0.0000	0.0000	0.0000	0.0000
Mobile	7.2000e-004	3.5600e-003	9.1400e-003	3.0000e-005	2.8000e-003	3.0000e-005	2.8200e-003	7.5000e-004	3.0000e-005	7.7000e-004		3.3504	3.3504	1.8000e-004		3.3549
<b>Total</b>	<b>0.0185</b>	<b>3.5700e-003</b>	<b>0.0108</b>	<b>3.0000e-005</b>	<b>2.8000e-003</b>	<b>4.0000e-005</b>	<b>2.8300e-003</b>	<b>7.5000e-004</b>	<b>4.0000e-005</b>	<b>7.8000e-004</b>		<b>3.3539</b>	<b>3.3539</b>	<b>1.9000e-004</b>	<b>0.0000</b>	<b>3.3586</b>

**Mitigated Operational**

	ROG	NOx	CO	SO2	Fugitive PM10	Exhaust PM10	PM10 Total	Fugitive PM2.5	Exhaust PM2.5	PM2.5 Total	Bio- CO2	NBio- CO2	Total CO2	CH4	N2O	CO2e
Category	lb/day										lb/day					
Area	0.0178	1.0000e-005	1.6400e-003	0.0000		1.0000e-005	1.0000e-005		1.0000e-005	1.0000e-005		3.5000e-003	3.5000e-003	1.0000e-005		3.7300e-003
Energy	0.0000	0.0000	0.0000	0.0000		0.0000	0.0000		0.0000	0.0000		0.0000	0.0000	0.0000	0.0000	0.0000
Mobile	7.2000e-004	3.5600e-003	9.1400e-003	3.0000e-005	2.8000e-003	3.0000e-005	2.8200e-003	7.5000e-004	3.0000e-005	7.7000e-004		3.3504	3.3504	1.8000e-004		3.3549
<b>Total</b>	<b>0.0185</b>	<b>3.5700e-003</b>	<b>0.0108</b>	<b>3.0000e-005</b>	<b>2.8000e-003</b>	<b>4.0000e-005</b>	<b>2.8300e-003</b>	<b>7.5000e-004</b>	<b>4.0000e-005</b>	<b>7.8000e-004</b>		<b>3.3539</b>	<b>3.3539</b>	<b>1.9000e-004</b>	<b>0.0000</b>	<b>3.3586</b>

TVMWD Production Well - Los Angeles-South Coast County, Winter

	ROG	NOx	CO	SO2	Fugitive PM10	Exhaust PM10	PM10 Total	Fugitive PM2.5	Exhaust PM2.5	PM2.5 Total	Bio- CO2	NBio-CO2	Total CO2	CH4	N2O	CO2e
Percent Reduction	0.00	0.00	0.00	0.00	0.00	0.00	0.00	0.00	0.00	0.00	0.00	0.00	0.00	0.00	0.00	0.00

**3.0 Construction Detail**

**Construction Phase**

Phase Number	Phase Name	Phase Type	Start Date	End Date	Num Days Week	Num Days	Phase Description
1	Site Preparation	Site Preparation	11/15/2019	11/15/2019	5	1	
2	Grading	Grading	11/16/2019	11/19/2019	5	2	
3	Building Construction	Building Construction	11/20/2019	2/7/2020	5	58	
4	Paving	Paving	2/8/2020	2/14/2020	5	5	
5	Architectural Coating	Architectural Coating	2/15/2020	2/21/2020	5	5	

Acres of Grading (Site Preparation Phase): 0.38

Acres of Grading (Grading Phase): 0.5

Acres of Paving: 0.34

Residential Indoor: 0; Residential Outdoor: 0; Non-Residential Indoor: 750; Non-Residential Outdoor: 250; Striped Parking Area: 900 (Architectural Coating – sqft)

**OffRoad Equipment**

Phase Name	Offroad Equipment Type	Amount	Usage Hours	Horse Power	Load Factor
Site Preparation	Graders	1	6.00	187	0.41
Site Preparation	Other Material Handling Equipment	1	8.00	168	0.40
Site Preparation	Rubber Tired Dozers	1	4.00	247	0.40
Site Preparation	Tractors/Loaders/Backhoes	1	6.00	97	0.37
Grading	Concrete/Industrial Saws	1	8.00	81	0.73

TVMWD Production Well - Los Angeles-South Coast County, Winter

Grading	Graders	1	4.00	187	0.41
Grading	Other Material Handling Equipment	1	4.00	168	0.40
Grading	Rubber Tired Dozers	1	4.00	247	0.40
Grading	Tractors/Loaders/Backhoes	1	4.00	97	0.37
Building Construction	Bore/Drill Rigs	1	24.00	221	0.50
Building Construction	Cranes	1	4.00	231	0.29
Building Construction	Forklifts	2	6.00	89	0.20
Building Construction	Generator Sets	1	24.00	84	0.74
Building Construction	Other Construction Equipment	1	8.00	172	0.42
Building Construction	Rubber Tired Dozers	1	4.00	247	0.40
Building Construction	Tractors/Loaders/Backhoes	2	8.00	97	0.37
Building Construction	Welders	1	4.00	46	0.45
Paving	Cement and Mortar Mixers	1	6.00	9	0.56
Paving	Concrete/Industrial Saws	1	8.00	81	0.73
Paving	Dumpers/Tenders	1	4.00	16	0.38
Paving	Graders	1	8.00	187	0.41
Paving	Pavers	1	7.00	130	0.42
Paving	Paving Equipment	1	8.00	172	0.42
Paving	Rollers	1	7.00	80	0.38
Paving	Rubber Tired Dozers	0		247	0.40
Paving	Tractors/Loaders/Backhoes	1	7.00	97	0.37
Paving	Welders	0		46	0.45
Architectural Coating	Air Compressors	1	6.00	78	0.48

**Trips and VMT**

TVMWD Production Well - Los Angeles-South Coast County, Winter

Phase Name	Offroad Equipment Count	Worker Trip Number	Vendor Trip Number	Hauling Trip Number	Worker Trip Length	Vendor Trip Length	Hauling Trip Length	Worker Vehicle Class	Vendor Vehicle Class	Hauling Vehicle Class
Site Preparation	4	10.00	0.00	0.00	14.70	6.90	20.00	LD_Mix	HDT_Mix	HHDT
Grading	5	10.00	0.00	0.00	14.70	6.90	20.00	LD_Mix	HDT_Mix	HHDT
Building Construction	10	7.00	3.00	0.00	14.70	6.90	20.00	LD_Mix	HDT_Mix	HHDT
Paving	8	15.00	0.00	0.00	14.70	6.90	20.00	LD_Mix	HDT_Mix	HHDT
Architectural Coating	1	1.00	0.00	0.00	14.70	6.90	20.00	LD_Mix	HDT_Mix	HHDT

3.1 Mitigation Measures Construction

Water Exposed Area

3.2 Site Preparation - 2019

Unmitigated Construction On-Site

	ROG	NOx	CO	SO2	Fugitive PM10	Exhaust PM10	PM10 Total	Fugitive PM2.5	Exhaust PM2.5	PM2.5 Total	Bio- CO2	NBio- CO2	Total CO2	CH4	N2O	CO2e
Category	lb/day										lb/day					
Fugitive Dust					3.4140	0.0000	3.4140	1.6986	0.0000	1.6986			0.0000			0.0000
Off-Road	1.4383	16.0123	9.0227	0.0174		0.7343	0.7343		0.6755	0.6755		1,718.7050	1,718.7050	0.5438		1,732.2995
<b>Total</b>	<b>1.4383</b>	<b>16.0123</b>	<b>9.0227</b>	<b>0.0174</b>	<b>3.4140</b>	<b>0.7343</b>	<b>4.1483</b>	<b>1.6986</b>	<b>0.6755</b>	<b>2.3742</b>		<b>1,718.7050</b>	<b>1,718.7050</b>	<b>0.5438</b>		<b>1,732.2995</b>

TVMWD Production Well - Los Angeles-South Coast County, Winter

**3.2 Site Preparation - 2019**

**Unmitigated Construction Off-Site**

	ROG	NOx	CO	SO2	Fugitive PM10	Exhaust PM10	PM10 Total	Fugitive PM2.5	Exhaust PM2.5	PM2.5 Total	Bio- CO2	NBio- CO2	Total CO2	CH4	N2O	CO2e
Category	lb/day										lb/day					
Hauling	0.0000	0.0000	0.0000	0.0000	0.0000	0.0000	0.0000	0.0000	0.0000	0.0000		0.0000	0.0000	0.0000		0.0000
Vendor	0.0000	0.0000	0.0000	0.0000	0.0000	0.0000	0.0000	0.0000	0.0000	0.0000		0.0000	0.0000	0.0000		0.0000
Worker	0.0554	0.0407	0.4425	1.1500e-003	0.1118	9.6000e-004	0.1127	0.0296	8.9000e-004	0.0305		114.2131	114.2131	3.9300e-003		114.3113
<b>Total</b>	<b>0.0554</b>	<b>0.0407</b>	<b>0.4425</b>	<b>1.1500e-003</b>	<b>0.1118</b>	<b>9.6000e-004</b>	<b>0.1127</b>	<b>0.0296</b>	<b>8.9000e-004</b>	<b>0.0305</b>		<b>114.2131</b>	<b>114.2131</b>	<b>3.9300e-003</b>		<b>114.3113</b>

**Mitigated Construction On-Site**

	ROG	NOx	CO	SO2	Fugitive PM10	Exhaust PM10	PM10 Total	Fugitive PM2.5	Exhaust PM2.5	PM2.5 Total	Bio- CO2	NBio- CO2	Total CO2	CH4	N2O	CO2e
Category	lb/day										lb/day					
Fugitive Dust					1.5363	0.0000	1.5363	0.7644	0.0000	0.7644			0.0000			0.0000
Off-Road	1.4383	16.0123	9.0227	0.0174		0.7343	0.7343		0.6755	0.6755	0.0000	1,718.7050	1,718.7050	0.5438		1,732.2995
<b>Total</b>	<b>1.4383</b>	<b>16.0123</b>	<b>9.0227</b>	<b>0.0174</b>	<b>1.5363</b>	<b>0.7343</b>	<b>2.2706</b>	<b>0.7644</b>	<b>0.6755</b>	<b>1.4399</b>	<b>0.0000</b>	<b>1,718.7050</b>	<b>1,718.7050</b>	<b>0.5438</b>		<b>1,732.2995</b>

TVMWD Production Well - Los Angeles-South Coast County, Winter

**3.2 Site Preparation - 2019**

**Mitigated Construction Off-Site**

	ROG	NOx	CO	SO2	Fugitive PM10	Exhaust PM10	PM10 Total	Fugitive PM2.5	Exhaust PM2.5	PM2.5 Total	Bio- CO2	NBio- CO2	Total CO2	CH4	N2O	CO2e
Category	lb/day										lb/day					
Hauling	0.0000	0.0000	0.0000	0.0000	0.0000	0.0000	0.0000	0.0000	0.0000	0.0000		0.0000	0.0000	0.0000		0.0000
Vendor	0.0000	0.0000	0.0000	0.0000	0.0000	0.0000	0.0000	0.0000	0.0000	0.0000		0.0000	0.0000	0.0000		0.0000
Worker	0.0554	0.0407	0.4425	1.1500e-003	0.1118	9.6000e-004	0.1127	0.0296	8.9000e-004	0.0305		114.2131	114.2131	3.9300e-003		114.3113
<b>Total</b>	<b>0.0554</b>	<b>0.0407</b>	<b>0.4425</b>	<b>1.1500e-003</b>	<b>0.1118</b>	<b>9.6000e-004</b>	<b>0.1127</b>	<b>0.0296</b>	<b>8.9000e-004</b>	<b>0.0305</b>		<b>114.2131</b>	<b>114.2131</b>	<b>3.9300e-003</b>		<b>114.3113</b>

**3.3 Grading - 2019**

**Unmitigated Construction On-Site**

	ROG	NOx	CO	SO2	Fugitive PM10	Exhaust PM10	PM10 Total	Fugitive PM2.5	Exhaust PM2.5	PM2.5 Total	Bio- CO2	NBio- CO2	Total CO2	CH4	N2O	CO2e
Category	lb/day										lb/day					
Fugitive Dust					3.2762	0.0000	3.2762	1.6837	0.0000	1.6837			0.0000			0.0000
Off-Road	1.5548	15.7279	9.8022	0.0183		0.7897	0.7897		0.7448	0.7448		1,784.0214	1,784.0214	0.4187		1,794.4876
<b>Total</b>	<b>1.5548</b>	<b>15.7279</b>	<b>9.8022</b>	<b>0.0183</b>	<b>3.2762</b>	<b>0.7897</b>	<b>4.0658</b>	<b>1.6837</b>	<b>0.7448</b>	<b>2.4286</b>		<b>1,784.0214</b>	<b>1,784.0214</b>	<b>0.4187</b>		<b>1,794.4876</b>



TVMWD Production Well - Los Angeles-South Coast County, Winter

**3.3 Grading - 2019**

**Unmitigated Construction Off-Site**

	ROG	NOx	CO	SO2	Fugitive PM10	Exhaust PM10	PM10 Total	Fugitive PM2.5	Exhaust PM2.5	PM2.5 Total	Bio- CO2	NBio- CO2	Total CO2	CH4	N2O	CO2e
Category	lb/day										lb/day					
Hauling	0.0000	0.0000	0.0000	0.0000	0.0000	0.0000	0.0000	0.0000	0.0000	0.0000		0.0000	0.0000	0.0000		0.0000
Vendor	0.0000	0.0000	0.0000	0.0000	0.0000	0.0000	0.0000	0.0000	0.0000	0.0000		0.0000	0.0000	0.0000		0.0000
Worker	0.0554	0.0407	0.4425	1.1500e-003	0.1118	9.6000e-004	0.1127	0.0296	8.9000e-004	0.0305		114.2131	114.2131	3.9300e-003		114.3113
<b>Total</b>	<b>0.0554</b>	<b>0.0407</b>	<b>0.4425</b>	<b>1.1500e-003</b>	<b>0.1118</b>	<b>9.6000e-004</b>	<b>0.1127</b>	<b>0.0296</b>	<b>8.9000e-004</b>	<b>0.0305</b>		<b>114.2131</b>	<b>114.2131</b>	<b>3.9300e-003</b>		<b>114.3113</b>

**Mitigated Construction On-Site**

	ROG	NOx	CO	SO2	Fugitive PM10	Exhaust PM10	PM10 Total	Fugitive PM2.5	Exhaust PM2.5	PM2.5 Total	Bio- CO2	NBio- CO2	Total CO2	CH4	N2O	CO2e
Category	lb/day										lb/day					
Fugitive Dust					1.4743	0.0000	1.4743	0.7577	0.0000	0.7577			0.0000			0.0000
Off-Road	1.5548	15.7279	9.8022	0.0183		0.7897	0.7897		0.7448	0.7448	0.0000	1,784.0214	1,784.0214	0.4187		1,794.4876
<b>Total</b>	<b>1.5548</b>	<b>15.7279</b>	<b>9.8022</b>	<b>0.0183</b>	<b>1.4743</b>	<b>0.7897</b>	<b>2.2639</b>	<b>0.7577</b>	<b>0.7448</b>	<b>1.5025</b>	<b>0.0000</b>	<b>1,784.0214</b>	<b>1,784.0214</b>	<b>0.4187</b>		<b>1,794.4876</b>

TVMWD Production Well - Los Angeles-South Coast County, Winter

**3.3 Grading - 2019**

**Mitigated Construction Off-Site**

	ROG	NOx	CO	SO2	Fugitive PM10	Exhaust PM10	PM10 Total	Fugitive PM2.5	Exhaust PM2.5	PM2.5 Total	Bio- CO2	NBio- CO2	Total CO2	CH4	N2O	CO2e
Category	lb/day										lb/day					
Hauling	0.0000	0.0000	0.0000	0.0000	0.0000	0.0000	0.0000	0.0000	0.0000	0.0000		0.0000	0.0000	0.0000		0.0000
Vendor	0.0000	0.0000	0.0000	0.0000	0.0000	0.0000	0.0000	0.0000	0.0000	0.0000		0.0000	0.0000	0.0000		0.0000
Worker	0.0554	0.0407	0.4425	1.1500e-003	0.1118	9.6000e-004	0.1127	0.0296	8.9000e-004	0.0305		114.2131	114.2131	3.9300e-003		114.3113
<b>Total</b>	<b>0.0554</b>	<b>0.0407</b>	<b>0.4425</b>	<b>1.1500e-003</b>	<b>0.1118</b>	<b>9.6000e-004</b>	<b>0.1127</b>	<b>0.0296</b>	<b>8.9000e-004</b>	<b>0.0305</b>		<b>114.2131</b>	<b>114.2131</b>	<b>3.9300e-003</b>		<b>114.3113</b>

**3.4 Building Construction - 2019**

**Unmitigated Construction On-Site**

	ROG	NOx	CO	SO2	Fugitive PM10	Exhaust PM10	PM10 Total	Fugitive PM2.5	Exhaust PM2.5	PM2.5 Total	Bio- CO2	NBio- CO2	Total CO2	CH4	N2O	CO2e
Category	lb/day										lb/day					
Off-Road	4.4127	44.7273	32.1076	0.0710		2.2386	2.2386		2.1177	2.1177		6,917.1477	6,917.1477	1.7001		6,959.6494
<b>Total</b>	<b>4.4127</b>	<b>44.7273</b>	<b>32.1076</b>	<b>0.0710</b>		<b>2.2386</b>	<b>2.2386</b>		<b>2.1177</b>	<b>2.1177</b>		<b>6,917.1477</b>	<b>6,917.1477</b>	<b>1.7001</b>		<b>6,959.6494</b>

TVMWD Production Well - Los Angeles-South Coast County, Winter

**3.4 Building Construction - 2019**

**Unmitigated Construction Off-Site**

	ROG	NOx	CO	SO2	Fugitive PM10	Exhaust PM10	PM10 Total	Fugitive PM2.5	Exhaust PM2.5	PM2.5 Total	Bio- CO2	NBio- CO2	Total CO2	CH4	N2O	CO2e
Category	lb/day										lb/day					
Hauling	0.0000	0.0000	0.0000	0.0000	0.0000	0.0000	0.0000	0.0000	0.0000	0.0000		0.0000	0.0000	0.0000		0.0000
Vendor	0.0130	0.3477	0.1015	7.6000e-004	0.0192	2.2500e-003	0.0215	5.5300e-003	2.1500e-003	7.6800e-003		81.3831	81.3831	5.7200e-003		81.5261
Worker	0.0388	0.0285	0.3097	8.0000e-004	0.0782	6.7000e-004	0.0789	0.0208	6.2000e-004	0.0214		79.9492	79.9492	2.7500e-003		80.0179
<b>Total</b>	<b>0.0518</b>	<b>0.3761</b>	<b>0.4113</b>	<b>1.5600e-003</b>	<b>0.0975</b>	<b>2.9200e-003</b>	<b>0.1004</b>	<b>0.0263</b>	<b>2.7700e-003</b>	<b>0.0291</b>		<b>161.3323</b>	<b>161.3323</b>	<b>8.4700e-003</b>		<b>161.5440</b>

**Mitigated Construction On-Site**

	ROG	NOx	CO	SO2	Fugitive PM10	Exhaust PM10	PM10 Total	Fugitive PM2.5	Exhaust PM2.5	PM2.5 Total	Bio- CO2	NBio- CO2	Total CO2	CH4	N2O	CO2e
Category	lb/day										lb/day					
Off-Road	4.4127	44.7273	32.1076	0.0710		2.2386	2.2386		2.1177	2.1177	0.0000	6,917.1477	6,917.1477	1.7001		6,959.6494
<b>Total</b>	<b>4.4127</b>	<b>44.7273</b>	<b>32.1076</b>	<b>0.0710</b>		<b>2.2386</b>	<b>2.2386</b>		<b>2.1177</b>	<b>2.1177</b>	<b>0.0000</b>	<b>6,917.1477</b>	<b>6,917.1477</b>	<b>1.7001</b>		<b>6,959.6494</b>

TVMWD Production Well - Los Angeles-South Coast County, Winter

**3.4 Building Construction - 2019**

**Mitigated Construction Off-Site**

	ROG	NOx	CO	SO2	Fugitive PM10	Exhaust PM10	PM10 Total	Fugitive PM2.5	Exhaust PM2.5	PM2.5 Total	Bio- CO2	NBio- CO2	Total CO2	CH4	N2O	CO2e
Category	lb/day										lb/day					
Hauling	0.0000	0.0000	0.0000	0.0000	0.0000	0.0000	0.0000	0.0000	0.0000	0.0000		0.0000	0.0000	0.0000		0.0000
Vendor	0.0130	0.3477	0.1015	7.6000e-004	0.0192	2.2500e-003	0.0215	5.5300e-003	2.1500e-003	7.6800e-003		81.3831	81.3831	5.7200e-003		81.5261
Worker	0.0388	0.0285	0.3097	8.0000e-004	0.0782	6.7000e-004	0.0789	0.0208	6.2000e-004	0.0214		79.9492	79.9492	2.7500e-003		80.0179
<b>Total</b>	<b>0.0518</b>	<b>0.3761</b>	<b>0.4113</b>	<b>1.5600e-003</b>	<b>0.0975</b>	<b>2.9200e-003</b>	<b>0.1004</b>	<b>0.0263</b>	<b>2.7700e-003</b>	<b>0.0291</b>		<b>161.3323</b>	<b>161.3323</b>	<b>8.4700e-003</b>		<b>161.5440</b>

**3.4 Building Construction - 2020**

**Unmitigated Construction On-Site**

	ROG	NOx	CO	SO2	Fugitive PM10	Exhaust PM10	PM10 Total	Fugitive PM2.5	Exhaust PM2.5	PM2.5 Total	Bio- CO2	NBio- CO2	Total CO2	CH4	N2O	CO2e
Category	lb/day										lb/day					
Off-Road	4.0962	41.5458	31.8177	0.0711		2.0129	2.0129		1.9025	1.9025		6,817.7166	6,817.7166	1.6875		6,859.9044
<b>Total</b>	<b>4.0962</b>	<b>41.5458</b>	<b>31.8177</b>	<b>0.0711</b>		<b>2.0129</b>	<b>2.0129</b>		<b>1.9025</b>	<b>1.9025</b>		<b>6,817.7166</b>	<b>6,817.7166</b>	<b>1.6875</b>		<b>6,859.9044</b>

TVMWD Production Well - Los Angeles-South Coast County, Winter

**3.4 Building Construction - 2020**

**Unmitigated Construction Off-Site**

	ROG	NOx	CO	SO2	Fugitive PM10	Exhaust PM10	PM10 Total	Fugitive PM2.5	Exhaust PM2.5	PM2.5 Total	Bio- CO2	NBio- CO2	Total CO2	CH4	N2O	CO2e
Category	lb/day										lb/day					
Hauling	0.0000	0.0000	0.0000	0.0000	0.0000	0.0000	0.0000	0.0000	0.0000	0.0000		0.0000	0.0000	0.0000		0.0000
Vendor	0.0112	0.3191	0.0922	7.6000e-004	0.0192	1.5300e-003	0.0207	5.5300e-003	1.4600e-003	6.9900e-003		80.8347	80.8347	5.4100e-003		80.9699
Worker	0.0358	0.0254	0.2807	7.8000e-004	0.0782	6.5000e-004	0.0789	0.0208	6.0000e-004	0.0214		77.5194	77.5194	2.4400e-003		77.5805
<b>Total</b>	<b>0.0469</b>	<b>0.3444</b>	<b>0.3729</b>	<b>1.5400e-003</b>	<b>0.0975</b>	<b>2.1800e-003</b>	<b>0.0996</b>	<b>0.0263</b>	<b>2.0600e-003</b>	<b>0.0283</b>		<b>158.3542</b>	<b>158.3542</b>	<b>7.8500e-003</b>		<b>158.5504</b>

**Mitigated Construction On-Site**

	ROG	NOx	CO	SO2	Fugitive PM10	Exhaust PM10	PM10 Total	Fugitive PM2.5	Exhaust PM2.5	PM2.5 Total	Bio- CO2	NBio- CO2	Total CO2	CH4	N2O	CO2e
Category	lb/day										lb/day					
Off-Road	4.0962	41.5458	31.8177	0.0711		2.0129	2.0129		1.9025	1.9025	0.0000	6,817.7166	6,817.7166	1.6875		6,859.9044
<b>Total</b>	<b>4.0962</b>	<b>41.5458</b>	<b>31.8177</b>	<b>0.0711</b>		<b>2.0129</b>	<b>2.0129</b>		<b>1.9025</b>	<b>1.9025</b>	<b>0.0000</b>	<b>6,817.7166</b>	<b>6,817.7166</b>	<b>1.6875</b>		<b>6,859.9044</b>

TVMWD Production Well - Los Angeles-South Coast County, Winter

**3.4 Building Construction - 2020**

**Mitigated Construction Off-Site**

	ROG	NOx	CO	SO2	Fugitive PM10	Exhaust PM10	PM10 Total	Fugitive PM2.5	Exhaust PM2.5	PM2.5 Total	Bio- CO2	NBio- CO2	Total CO2	CH4	N2O	CO2e
Category	lb/day										lb/day					
Hauling	0.0000	0.0000	0.0000	0.0000	0.0000	0.0000	0.0000	0.0000	0.0000	0.0000		0.0000	0.0000	0.0000		0.0000
Vendor	0.0112	0.3191	0.0922	7.6000e-004	0.0192	1.5300e-003	0.0207	5.5300e-003	1.4600e-003	6.9900e-003		80.8347	80.8347	5.4100e-003		80.9699
Worker	0.0358	0.0254	0.2807	7.8000e-004	0.0782	6.5000e-004	0.0789	0.0208	6.0000e-004	0.0214		77.5194	77.5194	2.4400e-003		77.5805
<b>Total</b>	<b>0.0469</b>	<b>0.3444</b>	<b>0.3729</b>	<b>1.5400e-003</b>	<b>0.0975</b>	<b>2.1800e-003</b>	<b>0.0996</b>	<b>0.0263</b>	<b>2.0600e-003</b>	<b>0.0283</b>		<b>158.3542</b>	<b>158.3542</b>	<b>7.8500e-003</b>		<b>158.5504</b>

**3.5 Paving - 2020**

**Unmitigated Construction On-Site**

	ROG	NOx	CO	SO2	Fugitive PM10	Exhaust PM10	PM10 Total	Fugitive PM2.5	Exhaust PM2.5	PM2.5 Total	Bio- CO2	NBio- CO2	Total CO2	CH4	N2O	CO2e
Category	lb/day										lb/day					
Off-Road	1.8855	19.5101	15.8980	0.0291		0.9349	0.9349		0.8775	0.8775		2,787.3469	2,787.3469	0.7324		2,805.6580
Paving	0.1205					0.0000	0.0000		0.0000	0.0000			0.0000			0.0000
<b>Total</b>	<b>2.0060</b>	<b>19.5101</b>	<b>15.8980</b>	<b>0.0291</b>		<b>0.9349</b>	<b>0.9349</b>		<b>0.8775</b>	<b>0.8775</b>		<b>2,787.3469</b>	<b>2,787.3469</b>	<b>0.7324</b>		<b>2,805.6580</b>

TVMWD Production Well - Los Angeles-South Coast County, Winter

**3.5 Paving - 2020**

**Unmitigated Construction Off-Site**

	ROG	NOx	CO	SO2	Fugitive PM10	Exhaust PM10	PM10 Total	Fugitive PM2.5	Exhaust PM2.5	PM2.5 Total	Bio- CO2	NBio- CO2	Total CO2	CH4	N2O	CO2e
Category	lb/day										lb/day					
Hauling	0.0000	0.0000	0.0000	0.0000	0.0000	0.0000	0.0000	0.0000	0.0000	0.0000		0.0000	0.0000	0.0000		0.0000
Vendor	0.0000	0.0000	0.0000	0.0000	0.0000	0.0000	0.0000	0.0000	0.0000	0.0000		0.0000	0.0000	0.0000		0.0000
Worker	0.0767	0.0544	0.6015	1.6700e-003	0.1677	1.4000e-003	0.1691	0.0445	1.2900e-003	0.0458		166.1131	166.1131	5.2400e-003		166.2440
<b>Total</b>	<b>0.0767</b>	<b>0.0544</b>	<b>0.6015</b>	<b>1.6700e-003</b>	<b>0.1677</b>	<b>1.4000e-003</b>	<b>0.1691</b>	<b>0.0445</b>	<b>1.2900e-003</b>	<b>0.0458</b>		<b>166.1131</b>	<b>166.1131</b>	<b>5.2400e-003</b>		<b>166.2440</b>

**Mitigated Construction On-Site**

	ROG	NOx	CO	SO2	Fugitive PM10	Exhaust PM10	PM10 Total	Fugitive PM2.5	Exhaust PM2.5	PM2.5 Total	Bio- CO2	NBio- CO2	Total CO2	CH4	N2O	CO2e
Category	lb/day										lb/day					
Off-Road	1.8855	19.5101	15.8980	0.0291		0.9349	0.9349		0.8775	0.8775	0.0000	2,787.3469	2,787.3469	0.7324		2,805.6580
Paving	0.1205					0.0000	0.0000		0.0000	0.0000			0.0000			0.0000
<b>Total</b>	<b>2.0060</b>	<b>19.5101</b>	<b>15.8980</b>	<b>0.0291</b>		<b>0.9349</b>	<b>0.9349</b>		<b>0.8775</b>	<b>0.8775</b>	<b>0.0000</b>	<b>2,787.3469</b>	<b>2,787.3469</b>	<b>0.7324</b>		<b>2,805.6580</b>

TVMWD Production Well - Los Angeles-South Coast County, Winter

**3.5 Paving - 2020**

**Mitigated Construction Off-Site**

	ROG	NOx	CO	SO2	Fugitive PM10	Exhaust PM10	PM10 Total	Fugitive PM2.5	Exhaust PM2.5	PM2.5 Total	Bio- CO2	NBio- CO2	Total CO2	CH4	N2O	CO2e
Category	lb/day										lb/day					
Hauling	0.0000	0.0000	0.0000	0.0000	0.0000	0.0000	0.0000	0.0000	0.0000	0.0000		0.0000	0.0000	0.0000		0.0000
Vendor	0.0000	0.0000	0.0000	0.0000	0.0000	0.0000	0.0000	0.0000	0.0000	0.0000		0.0000	0.0000	0.0000		0.0000
Worker	0.0767	0.0544	0.6015	1.6700e-003	0.1677	1.4000e-003	0.1691	0.0445	1.2900e-003	0.0458		166.1131	166.1131	5.2400e-003		166.2440
<b>Total</b>	<b>0.0767</b>	<b>0.0544</b>	<b>0.6015</b>	<b>1.6700e-003</b>	<b>0.1677</b>	<b>1.4000e-003</b>	<b>0.1691</b>	<b>0.0445</b>	<b>1.2900e-003</b>	<b>0.0458</b>		<b>166.1131</b>	<b>166.1131</b>	<b>5.2400e-003</b>		<b>166.2440</b>

**3.6 Architectural Coating - 2020**

**Unmitigated Construction On-Site**

	ROG	NOx	CO	SO2	Fugitive PM10	Exhaust PM10	PM10 Total	Fugitive PM2.5	Exhaust PM2.5	PM2.5 Total	Bio- CO2	NBio- CO2	Total CO2	CH4	N2O	CO2e
Category	lb/day										lb/day					
Archit. Coating	1.7613					0.0000	0.0000		0.0000	0.0000			0.0000			0.0000
Off-Road	0.2422	1.6838	1.8314	2.9700e-003		0.1109	0.1109		0.1109	0.1109		281.4481	281.4481	0.0218		281.9928
<b>Total</b>	<b>2.0035</b>	<b>1.6838</b>	<b>1.8314</b>	<b>2.9700e-003</b>		<b>0.1109</b>	<b>0.1109</b>		<b>0.1109</b>	<b>0.1109</b>		<b>281.4481</b>	<b>281.4481</b>	<b>0.0218</b>		<b>281.9928</b>



TVMWD Production Well - Los Angeles-South Coast County, Winter

**3.6 Architectural Coating - 2020**

**Unmitigated Construction Off-Site**

	ROG	NOx	CO	SO2	Fugitive PM10	Exhaust PM10	PM10 Total	Fugitive PM2.5	Exhaust PM2.5	PM2.5 Total	Bio- CO2	NBio- CO2	Total CO2	CH4	N2O	CO2e
Category	lb/day										lb/day					
Hauling	0.0000	0.0000	0.0000	0.0000	0.0000	0.0000	0.0000	0.0000	0.0000	0.0000		0.0000	0.0000	0.0000		0.0000
Vendor	0.0000	0.0000	0.0000	0.0000	0.0000	0.0000	0.0000	0.0000	0.0000	0.0000		0.0000	0.0000	0.0000		0.0000
Worker	5.1100e-003	3.6200e-003	0.0401	1.1000e-004	0.0112	9.0000e-005	0.0113	2.9600e-003	9.0000e-005	3.0500e-003		11.0742	11.0742	3.5000e-004		11.0829
<b>Total</b>	<b>5.1100e-003</b>	<b>3.6200e-003</b>	<b>0.0401</b>	<b>1.1000e-004</b>	<b>0.0112</b>	<b>9.0000e-005</b>	<b>0.0113</b>	<b>2.9600e-003</b>	<b>9.0000e-005</b>	<b>3.0500e-003</b>		<b>11.0742</b>	<b>11.0742</b>	<b>3.5000e-004</b>		<b>11.0829</b>

**Mitigated Construction On-Site**

	ROG	NOx	CO	SO2	Fugitive PM10	Exhaust PM10	PM10 Total	Fugitive PM2.5	Exhaust PM2.5	PM2.5 Total	Bio- CO2	NBio- CO2	Total CO2	CH4	N2O	CO2e
Category	lb/day										lb/day					
Archit. Coating	1.7613					0.0000	0.0000		0.0000	0.0000			0.0000			0.0000
Off-Road	0.2422	1.6838	1.8314	2.9700e-003		0.1109	0.1109		0.1109	0.1109	0.0000	281.4481	281.4481	0.0218		281.9928
<b>Total</b>	<b>2.0035</b>	<b>1.6838</b>	<b>1.8314</b>	<b>2.9700e-003</b>		<b>0.1109</b>	<b>0.1109</b>		<b>0.1109</b>	<b>0.1109</b>	<b>0.0000</b>	<b>281.4481</b>	<b>281.4481</b>	<b>0.0218</b>		<b>281.9928</b>

TVMWD Production Well - Los Angeles-South Coast County, Winter

**3.6 Architectural Coating - 2020**

**Mitigated Construction Off-Site**

	ROG	NOx	CO	SO2	Fugitive PM10	Exhaust PM10	PM10 Total	Fugitive PM2.5	Exhaust PM2.5	PM2.5 Total	Bio- CO2	NBio- CO2	Total CO2	CH4	N2O	CO2e
Category	lb/day										lb/day					
Hauling	0.0000	0.0000	0.0000	0.0000	0.0000	0.0000	0.0000	0.0000	0.0000	0.0000		0.0000	0.0000	0.0000		0.0000
Vendor	0.0000	0.0000	0.0000	0.0000	0.0000	0.0000	0.0000	0.0000	0.0000	0.0000		0.0000	0.0000	0.0000		0.0000
Worker	5.1100e-003	3.6200e-003	0.0401	1.1000e-004	0.0112	9.0000e-005	0.0113	2.9600e-003	9.0000e-005	3.0500e-003		11.0742	11.0742	3.5000e-004		11.0829
<b>Total</b>	<b>5.1100e-003</b>	<b>3.6200e-003</b>	<b>0.0401</b>	<b>1.1000e-004</b>	<b>0.0112</b>	<b>9.0000e-005</b>	<b>0.0113</b>	<b>2.9600e-003</b>	<b>9.0000e-005</b>	<b>3.0500e-003</b>		<b>11.0742</b>	<b>11.0742</b>	<b>3.5000e-004</b>		<b>11.0829</b>

**4.0 Operational Detail - Mobile**

---

**4.1 Mitigation Measures Mobile**

TVMWD Production Well - Los Angeles-South Coast County, Winter

	ROG	NOx	CO	SO2	Fugitive PM10	Exhaust PM10	PM10 Total	Fugitive PM2.5	Exhaust PM2.5	PM2.5 Total	Bio- CO2	NBio- CO2	Total CO2	CH4	N2O	CO2e
Category	lb/day										lb/day					
Mitigated	7.2000e-004	3.5600e-003	9.1400e-003	3.0000e-005	2.8000e-003	3.0000e-005	2.8200e-003	7.5000e-004	3.0000e-005	7.7000e-004		3.3504	3.3504	1.8000e-004		3.3549
Unmitigated	7.2000e-004	3.5600e-003	9.1400e-003	3.0000e-005	2.8000e-003	3.0000e-005	2.8200e-003	7.5000e-004	3.0000e-005	7.7000e-004		3.3504	3.3504	1.8000e-004		3.3549

4.2 Trip Summary Information

Land Use	Average Daily Trip Rate			Unmitigated	Mitigated
	Weekday	Saturday	Sunday	Annual VMT	Annual VMT
Other Non-Asphalt Surfaces	0.00	0.00	0.00		
Parking Lot	0.00	0.00	0.00		
User Defined Industrial	0.43	0.00	0.00	939	939
Total	0.43	0.00	0.00	939	939

4.3 Trip Type Information

Land Use	Miles			Trip %			Trip Purpose %		
	H-W or C-W	H-S or C-C	H-O or C-NW	H-W or C-W	H-S or C-C	H-O or C-NW	Primary	Diverted	Pass-by
Other Non-Asphalt Surfaces	16.60	8.40	6.90	0.00	0.00	0.00	0	0	0
Parking Lot	16.60	8.40	6.90	0.00	0.00	0.00	0	0	0
User Defined Industrial	16.60	8.40	6.90	0.00	100.00	0.00	100	0	0

4.4 Fleet Mix

TVMWD Production Well - Los Angeles-South Coast County, Winter

Land Use	LDA	LDT1	LDT2	MDV	LHD1	LHD2	MHD	HHD	OBUS	UBUS	MCY	SBUS	MH
Other Non-Asphalt Surfaces	0.546501	0.044961	0.204016	0.120355	0.015740	0.006196	0.020131	0.030678	0.002515	0.002201	0.005142	0.000687	0.000876
Parking Lot	0.546501	0.044961	0.204016	0.120355	0.015740	0.006196	0.020131	0.030678	0.002515	0.002201	0.005142	0.000687	0.000876
User Defined Industrial	0.546501	0.044961	0.204016	0.120355	0.015740	0.006196	0.020131	0.030678	0.002515	0.002201	0.005142	0.000687	0.000876

**5.0 Energy Detail**

Historical Energy Use: N

**5.1 Mitigation Measures Energy**

	ROG	NOx	CO	SO2	Fugitive PM10	Exhaust PM10	PM10 Total	Fugitive PM2.5	Exhaust PM2.5	PM2.5 Total	Bio- CO2	NBio- CO2	Total CO2	CH4	N2O	CO2e
Category	lb/day										lb/day					
NaturalGas Mitigated	0.0000	0.0000	0.0000	0.0000		0.0000	0.0000		0.0000	0.0000		0.0000	0.0000	0.0000	0.0000	0.0000
NaturalGas Unmitigated	0.0000	0.0000	0.0000	0.0000		0.0000	0.0000		0.0000	0.0000		0.0000	0.0000	0.0000	0.0000	0.0000

TVMWD Production Well - Los Angeles-South Coast County, Winter

**5.2 Energy by Land Use - Natural Gas**

**Unmitigated**

	Natural Gas Use	ROG	NOx	CO	SO2	Fugitive PM10	Exhaust PM10	PM10 Total	Fugitive PM2.5	Exhaust PM2.5	PM2.5 Total	Bio- CO2	NBio- CO2	Total CO2	CH4	N2O	CO2e
Land Use	kBTU/yr	lb/day										lb/day					
Other Non-Asphalt Surfaces	0	0.0000	0.0000	0.0000	0.0000		0.0000	0.0000		0.0000	0.0000		0.0000	0.0000	0.0000	0.0000	0.0000
Parking Lot	0	0.0000	0.0000	0.0000	0.0000		0.0000	0.0000		0.0000	0.0000		0.0000	0.0000	0.0000	0.0000	0.0000
User Defined Industrial	0	0.0000	0.0000	0.0000	0.0000		0.0000	0.0000		0.0000	0.0000		0.0000	0.0000	0.0000	0.0000	0.0000
<b>Total</b>		<b>0.0000</b>	<b>0.0000</b>	<b>0.0000</b>	<b>0.0000</b>		<b>0.0000</b>	<b>0.0000</b>		<b>0.0000</b>	<b>0.0000</b>		<b>0.0000</b>	<b>0.0000</b>	<b>0.0000</b>	<b>0.0000</b>	<b>0.0000</b>

**Mitigated**

	Natural Gas Use	ROG	NOx	CO	SO2	Fugitive PM10	Exhaust PM10	PM10 Total	Fugitive PM2.5	Exhaust PM2.5	PM2.5 Total	Bio- CO2	NBio- CO2	Total CO2	CH4	N2O	CO2e
Land Use	kBTU/yr	lb/day										lb/day					
Other Non-Asphalt Surfaces	0	0.0000	0.0000	0.0000	0.0000		0.0000	0.0000		0.0000	0.0000		0.0000	0.0000	0.0000	0.0000	0.0000
Parking Lot	0	0.0000	0.0000	0.0000	0.0000		0.0000	0.0000		0.0000	0.0000		0.0000	0.0000	0.0000	0.0000	0.0000
User Defined Industrial	0	0.0000	0.0000	0.0000	0.0000		0.0000	0.0000		0.0000	0.0000		0.0000	0.0000	0.0000	0.0000	0.0000
<b>Total</b>		<b>0.0000</b>	<b>0.0000</b>	<b>0.0000</b>	<b>0.0000</b>		<b>0.0000</b>	<b>0.0000</b>		<b>0.0000</b>	<b>0.0000</b>		<b>0.0000</b>	<b>0.0000</b>	<b>0.0000</b>	<b>0.0000</b>	<b>0.0000</b>

**6.0 Area Detail**

TVMWD Production Well - Los Angeles-South Coast County, Winter

**6.1 Mitigation Measures Area**

	ROG	NOx	CO	SO2	Fugitive PM10	Exhaust PM10	PM10 Total	Fugitive PM2.5	Exhaust PM2.5	PM2.5 Total	Bio- CO2	NBio- CO2	Total CO2	CH4	N2O	CO2e
Category	lb/day										lb/day					
Mitigated	0.0178	1.0000e-005	1.6400e-003	0.0000		1.0000e-005	1.0000e-005		1.0000e-005	1.0000e-005		3.5000e-003	3.5000e-003	1.0000e-005		3.7300e-003
Unmitigated	0.0178	1.0000e-005	1.6400e-003	0.0000		1.0000e-005	1.0000e-005		1.0000e-005	1.0000e-005		3.5000e-003	3.5000e-003	1.0000e-005		3.7300e-003

**6.2 Area by SubCategory**

Unmitigated

	ROG	NOx	CO	SO2	Fugitive PM10	Exhaust PM10	PM10 Total	Fugitive PM2.5	Exhaust PM2.5	PM2.5 Total	Bio- CO2	NBio- CO2	Total CO2	CH4	N2O	CO2e
SubCategory	lb/day										lb/day					
Architectural Coating	2.4100e-003					0.0000	0.0000		0.0000	0.0000			0.0000			0.0000
Consumer Products	0.0152					0.0000	0.0000		0.0000	0.0000			0.0000			0.0000
Landscaping	1.5000e-004	1.0000e-005	1.6400e-003	0.0000		1.0000e-005	1.0000e-005		1.0000e-005	1.0000e-005		3.5000e-003	3.5000e-003	1.0000e-005		3.7300e-003
<b>Total</b>	<b>0.0178</b>	<b>1.0000e-005</b>	<b>1.6400e-003</b>	<b>0.0000</b>		<b>1.0000e-005</b>	<b>1.0000e-005</b>		<b>1.0000e-005</b>	<b>1.0000e-005</b>		<b>3.5000e-003</b>	<b>3.5000e-003</b>	<b>1.0000e-005</b>		<b>3.7300e-003</b>

TVMWD Production Well - Los Angeles-South Coast County, Winter

**6.2 Area by SubCategory**

Mitigated

	ROG	NOx	CO	SO2	Fugitive PM10	Exhaust PM10	PM10 Total	Fugitive PM2.5	Exhaust PM2.5	PM2.5 Total	Bio- CO2	NBio- CO2	Total CO2	CH4	N2O	CO2e
SubCategory	lb/day										lb/day					
Architectural Coating	2.4100e-003					0.0000	0.0000		0.0000	0.0000			0.0000			0.0000
Consumer Products	0.0152					0.0000	0.0000		0.0000	0.0000			0.0000			0.0000
Landscaping	1.5000e-004	1.0000e-005	1.6400e-003	0.0000		1.0000e-005	1.0000e-005		1.0000e-005	1.0000e-005		3.5000e-003	3.5000e-003	1.0000e-005		3.7300e-003
<b>Total</b>	<b>0.0178</b>	<b>1.0000e-005</b>	<b>1.6400e-003</b>	<b>0.0000</b>		<b>1.0000e-005</b>	<b>1.0000e-005</b>		<b>1.0000e-005</b>	<b>1.0000e-005</b>		<b>3.5000e-003</b>	<b>3.5000e-003</b>	<b>1.0000e-005</b>		<b>3.7300e-003</b>

**7.0 Water Detail**

**7.1 Mitigation Measures Water**

**8.0 Waste Detail**

**8.1 Mitigation Measures Waste**

**9.0 Operational Offroad**

Equipment Type	Number	Hours/Day	Days/Year	Horse Power	Load Factor	Fuel Type
----------------	--------	-----------	-----------	-------------	-------------	-----------

**10.0 Stationary Equipment**

Fire Pumps and Emergency Generators

TVMWD Production Well - Los Angeles-South Coast County, Winter

Equipment Type	Number	Hours/Day	Hours/Year	Horse Power	Load Factor	Fuel Type
----------------	--------	-----------	------------	-------------	-------------	-----------

**Boilers**

Equipment Type	Number	Heat Input/Day	Heat Input/Year	Boiler Rating	Fuel Type
----------------	--------	----------------	-----------------	---------------	-----------

**User Defined Equipment**

Equipment Type	Number
----------------	--------

**11.0 Vegetation**

---



APPENDIX A.2  
ENERGY DATA SHEETS

## TVMWD Production Well

Compression-Ignition Engine Brake-Specific Fuel Consumption (BSFC) Factors [1]:

HP: 0 to 100

0.059

HP: Greater than 100

0.0529

Values above are expressed in gallons per horsepower-hour/BSFC.

**CONSTRUCTION EQUIPMENT**

<b>Construction Equipment</b>	<b>#</b>	<b>Hours per Day</b>	<b>Horsepower</b>	<b>Load Factor</b>	<b>Construction Phase</b>	<b>Fuel Used (gallons)</b>
Graders	1	6	187	0.410	Site Prep	24.34
Other Material Handling Eq.	1	8	168	0.400	Site Prep	28.44
Rubber Tired Dozer	1	4	247	0.400	Site Prep	20.91
Tractors/Loaders/Backhoes	1	6	97	0.370	Site Prep	12.66
Concrete/Industrial Saws	1	8	81	0.730	Grading	55.63
Graders	1	4	187	0.410	Grading	32.45
Other Material Handling Eq.	1	4	168	0.400	Grading	28.44
Rubber Tired Dozer	1	4	247	0.400	Grading	41.81
Tractors/Loaders/Backhoes	1	4	97	0.370	Grading	16.88
Bore/Drill Rig	1	24	221	0.500	Building Con.	8698.0296
Cranes	1	4	231	0.290	Building Con.	878.86
Forklifts	2	6	89	0.200	Building Con.	389.35
Generator Sets	1	24	84	0.740	Building Con.	5438.65
Other Construction Eq.	1	8	172	0.420	Building Con.	1895.46
Rubber Tired Dozer	1	4	247	0.400	Building Con.	1296.18
Tractors/Loaders/Backhoes	2	8	97	0.370	Building Con.	1046.72
Welders	1	4	46	0.450	Building Con.	301.86
Cement and Motor Mixers	1	6	9	0.560	Paving	8.89
Concrete/Industrial Saws	1	8	81	0.730	Paving	139.07
Dumpers/Tenders	1	4	16	0.380	Paving	7.15
Graders	1	8	187	0.410	Paving	162.23
Pavers	1	7	130	0.420	Paving	101.09
Paving Equipment	1	8	172	0.420	Paving	152.86
Rollers	1	7	80	0.380	Paving	62.56
Tractors/Loaders/Backhoes	1	7	97	0.370	Paving	73.86
Air Compressors	1	6	78	0.480	Architectual Coat.	66.04
<b>Total Fuel Used</b>						<b>20980.43</b>
						<b>(Gallons)</b>

<b>Construction Phase</b>	<b>Days of Operation</b>
Site Preparation	1
Grading	2
Building Construction	62
Paving	5
Architectual Coating	5

**WORKER TRIPS**

<b>Construction Phase</b>	<b>MPG [2]</b>	<b>Trips</b>	<b>Trip Length (miles)</b>	<b>Fuel Used (gallons)</b>
Site Preparation Phase	24.0	10	15.0	6.25
Grading	24.0	10	15.0	12.50
Building Construction Phase	24.0	7	15.0	253.75
Paving Phase	24.0	15	15.0	46.88
Architectural Coating	24.0	1	15.0	3.13
<b>Total</b>				<b>322.50</b>

**VENDOR TRIPS**

<b>Construction Phase</b>	<b>MPG [2]</b>	<b>Trips</b>	<b>Trip Length (miles)</b>	<b>Fuel Used (gallons)</b>
Site Preparation Phase	7.4	0	7.0	0.00
Grading	7.4	0	7.0	0.00
Building Construction Phase	7.4	3	7.0	164.59
Paving Phase	7.4	0	7.0	0.00
<b>Total</b>				<b>164.59</b>

<b>Total Gasoline Consumption (gallons)</b>	<b>487.09</b>
<b>Total Diesel Consumption (gallons)</b>	<b>20980.43</b>

**Sources:**

[1] United States Environmental Protection Agency. 2018. *Exhaust and Crankcase Emission Factors for Nonrod Compression-Ignition Engines in MOVES2014b*. July 2018. Available at: <https://nepis.epa.gov/Exe/ZyPDF.cgi?Dockey=P100UXEN.pdf>.

[2] United States Department of Transportation, Bureau of Transportation Statistics. 2018. *National Transportation Statistics 2018*. Available at: <https://www.bts.gov/sites/bts.dot.gov/files/docs/browse-statistical-products-and-data/national-transportation-statistics/223001/ntentire2018q4.pdf>.

## TVMWD Pipeline

Compression-Ignition Engine Brake-Specific Fuel Consumption (BSFC) Factors [1]:

HP: 0 to 100	0.0588	HP: Greater than 100	0.0529
--------------	--------	----------------------	--------

Values above are expressed in gallons per horsepower-hour/BSFC.

**CONSTRUCTION EQUIPMENT**

<b>Construction Equipment</b>	<b>#</b>	<b>Hours per Day</b>	<b>Horsepower</b>	<b>Load Factor</b>	<b>Construction Phase</b>	<b>Fuel Used (gallons)</b>
Tractors/Loaders/Backhoes	1	6	97	0.370	Building Con.	949.65
Cranes	1	6	231	0.290	Building Con.	1594.70
Forklifts	1	6	89	0.200	Building Con.	470.99
Generator Sets	1	8	84	0.740	Building Con.	2193.00
Other Construction Eqp.	2	6	89	0.420	Building Con.	889.83
Concrete/Industrial Saws	1	6	84	0.730	Building Con.	1459.72
Dumpers/Tenders	1	6	46	0.380	Building Con.	462.52
Welders	3	8	46	0.450	Building Con.	730.30
Cement and Motor Mixers	1	6	9	0.560	Paving	8.89
Pavers	1	6	130	0.420	Paving	86.65
Paving Equipment	1	8	132	0.420	Paving	117.31
Rollers	1	7	80	0.380	Paving	62.56
Tractors/Loaders/Backhoes	1	8	97	0.370	Paving	84.41
<b>Total Fuel Used</b>						<b>9110.54</b>
						<b>(Gallons)</b>

<b>Construction Phase</b>	<b>Days of Operation</b>
Site Preparation	0
Grading	0
Building Construction	75
Paving	5
Architectual Coating	0

**WORKER TRIPS**

<b>Construction Phase</b>	<b>MPG [2]</b>	<b>Trips</b>	<b>Trip Length (miles)</b>	<b>Fuel Used (gallons)</b>
Building Construction Phase	24.0	11	15.0	550.00
Paving Phase	24.0	13	15.0	162.50
<b>Total</b>				<b>712.50</b>

<b>Total Gasoline Consumption (gallons)</b>	<b>712.50</b>
<b>Total Diesel Consumption (gallons)</b>	<b>910.54</b>

**Sources:**

[1] United States Environmental Protection Agency. 2018. *Exhaust and Crankcase Emission Factors for Nonrod Compression-Ignition Engines in MOVES2014b*. July 2018. Available at: <https://nepis.epa.gov/Exe/ZyPDF.cgi?Dockey=P100UXEN.pdf>.

[2] United States Department of Transportation, Bureau of Transportation Statistics. 2018. *National Transportation Statistics 2018*. Available at: <https://www.bts.gov/sites/bts.dot.gov/files/docs/browse-statistical-products-and-data/national-transportation-statistics/223001/ntentire2018q4.pdf>.

**Appendix B: Cultural Resources Assessment**

**HISTORICAL/ARCHAEOLOGICAL RESOURCES SURVEY REPORT**

**TVMWD WELL NO. 4 PROJECT**

**Assessor's Parcel Number 8671-009-019  
City of Claremont, Los Angeles County, California**

**For Submittal to:**

Three Valleys Municipal Water District  
1021 East Miramar Avenue  
Claremont, CA 91711

**Prepared for:**

Jericho Systems, Inc.  
47 North First Street, Suite 1  
Redlands, CA 92373

**Prepared by:**

CRM TECH  
1016 East Cooley Drive, Suite A/B  
Colton, CA 92324

Bai "Tom" Tang, Principal Investigator  
Michael Hogan, Principal Investigator

September 2, 2019  
CRM TECH Contract No. 3513

**Title:** Historical/Archaeological Resources Survey Report: TVMWD Well No. 4 Project, Assessor's Parcel Number 8671-009-019, City of Claremont, Los Angeles County, California

**Author(s):** Ben Kerridge, Archaeologist  
Daniel Ballester, Archaeologist/Field Director

**Consulting Firm:** CRM TECH  
1016 East Cooley Drive, Suite A/B  
Colton, CA 92324  
(909) 824-6400

**Date:** September 2, 2019

**For Submittal to:** Three Valleys Municipal Water District  
1021 East Miramar Avenue  
Claremont, CA 91711  
(909) 621-5568

**Prepared for:** Julie A. Gilbert  
Jericho Systems, Inc.  
47 North First Street, Suite 1  
Redlands, CA 92373  
(909) 307-5633

**USGS Quadrangle:** Mount Baldy, Calif., 7.5' quadrangle (Section 34, T1N R8W, San Bernardino Baseline and Meridian)

**Project Size:** Approximately one acre

**Keywords:** Western San Bernardino Valley; Phase I cultural resources study; no "historical resources" under CEQA

## MANAGEMENT SUMMARY

Between June and August 2019, at the request of Jericho Systems, Inc., CRM TECH performed a cultural resources study on approximately one acre of vacant land in the City of Claremont, Los Angeles County, California. The subject property of the study, Assessor's Parcel No. 8671-009-019, is located on the northwestern corner of Grand Avenue and Miramar Avenue, in the northeast quarter of Section 34, T1N R8W, San Bernardino Baseline and Meridian.

The study is part of the environmental review process for the proposed Three Valleys Municipal Water District (TVMWD) Well No. 4 Project, which entails the development of a water production well and associated improvements on the southern portion of the parcel, including a building to house the well and its pumping equipment, a perimeter wall/fence, and sidewalks with new landscaping along the Grand Avenue and Miramar Avenue frontages.

As the lead agency for the project, TVMWD required the study in compliance with the California Environmental Quality Act (CEQA). The purpose of the study is to provide TVMWD with the necessary information and analysis to determine whether the proposed project would cause substantial adverse changes to any "historical resources," as defined by CEQA, that may exist in or near the project area.

In order to identify such resources, CRM TECH conducted a historical/archaeological resources records search, consulted with Native American representatives, pursued historical background research, and carried out an intensive-level field survey. Throughout the course of the study, no "historical resources" were encountered within or adjacent to the project area. Therefore, CRM TECH recommends to TVMWD a finding of *No Impact* on "historical resources."

No further cultural resources investigation is recommended for this project unless construction plans undergo such changes as to include areas not covered by this study. However, if buried cultural materials are encountered during any earth-moving operations associated with the project, all work within 50 feet of the discovery should be halted or diverted until a qualified archaeologist can evaluate the nature and significance of the finds.



## TABLE OF CONTENTS

MANAGEMENT SUMMARY .....	i
INTRODUCTION .....	1
SETTING.....	4
Current Natural Setting.....	4
Cultural Setting.....	5
Prehistoric Context.....	5
Ethnohistoric Context .....	5
Historic Context.....	6
RESEARCH METHODS .....	7
Records Search.....	7
Native American Participation.....	8
Historical Background Research.....	8
Field Survey .....	8
RESULTS AND FINDINGS.....	8
Records Search.....	8
Native American Participation.....	9
Historical Background Research.....	11
Field Survey .....	11
DISCUSSION.....	12
CONCLUSION AND RECOMMENDATIONS .....	13
REFERENCES .....	13
APPENDIX 1: Personnel Qualifications .....	16
APPENDIX 2: Correspondence with Native American Representatives.....	20

## LIST OF FIGURES

Figure 1. Project vicinity.....	1
Figure 2. Project location.....	2
Figure 3. Aerial view of the project area .....	3
Figure 4. Overview of the project area .....	4
Figure 5. Previous cultural resources studies.....	10
Figure 6. The project area and vicinity in 1852-1865.....	11
Figure 7. The project area and vicinity in 1894.....	11
Figure 8. The project area and vicinity in 1952-1953.....	12
Figure 9. The project area and vicinity in 1966-1967.....	12

## INTRODUCTION

Between June and August 2019, at the request of Jericho Systems, Inc., CRM TECH performed a cultural resources study on approximately one acre of vacant land in the City of Claremont, Los Angeles County, California (Figure 1). The subject property of the study, Assessor's Parcel No. 8671-009-019, is located on the northwestern corner of Grand Avenue and Miramar Avenue, in the northeast quarter of Section 34, T1N R8W, San Bernardino Baseline and Meridian (Figures 2, 3).

The study is part of the environmental review process for the proposed Three Valleys Municipal Water District (TVMWD) Well No. 4 Project, which entails the development of a water production well and associated improvements on the southern portion of the parcel, including a building to house the well and its pumping equipment, a perimeter wall/fence, and sidewalks with new landscaping along the Grand Avenue and Miramar Avenue frontages. As the lead agency for the project, TVMWD required the study in compliance with the California Environmental Quality Act (CEQA). The purpose of the study is to provide TVMWD with the necessary information and analysis to determine whether the proposed project would cause substantial adverse changes to any "historical resources," as defined by CEQA, that may exist in or near the project area.

In order to identify such resources, CRM TECH conducted a historical/archaeological resources records search, consulted with Native American representatives, pursued historical background research, and carried out an intensive-level field survey. The following report is a complete account of the methods, results, and final conclusion of the study. Personnel who participated in the study are named in the appropriate sections below, and their qualifications are provided in Appendix 1.

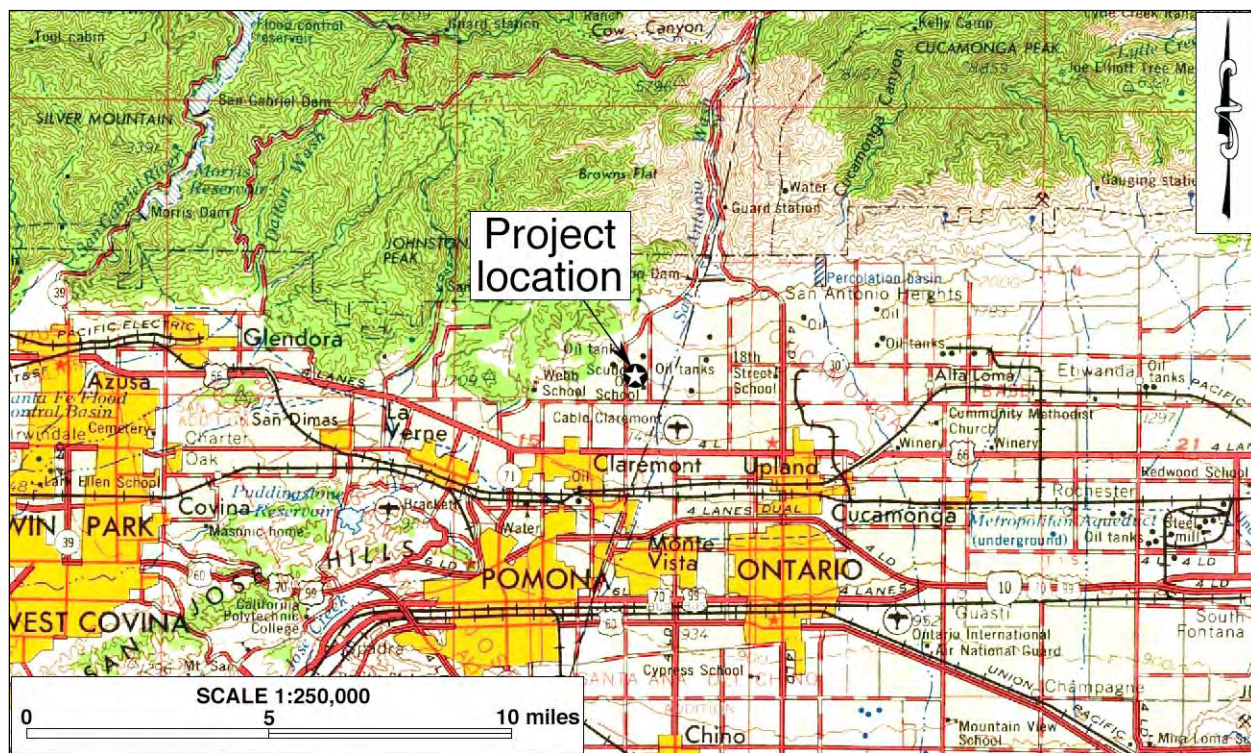

Figure 1. Project vicinity. (Based on USGS San Bernardino, Calif., 30x60' quadrangle [USGS 1969])

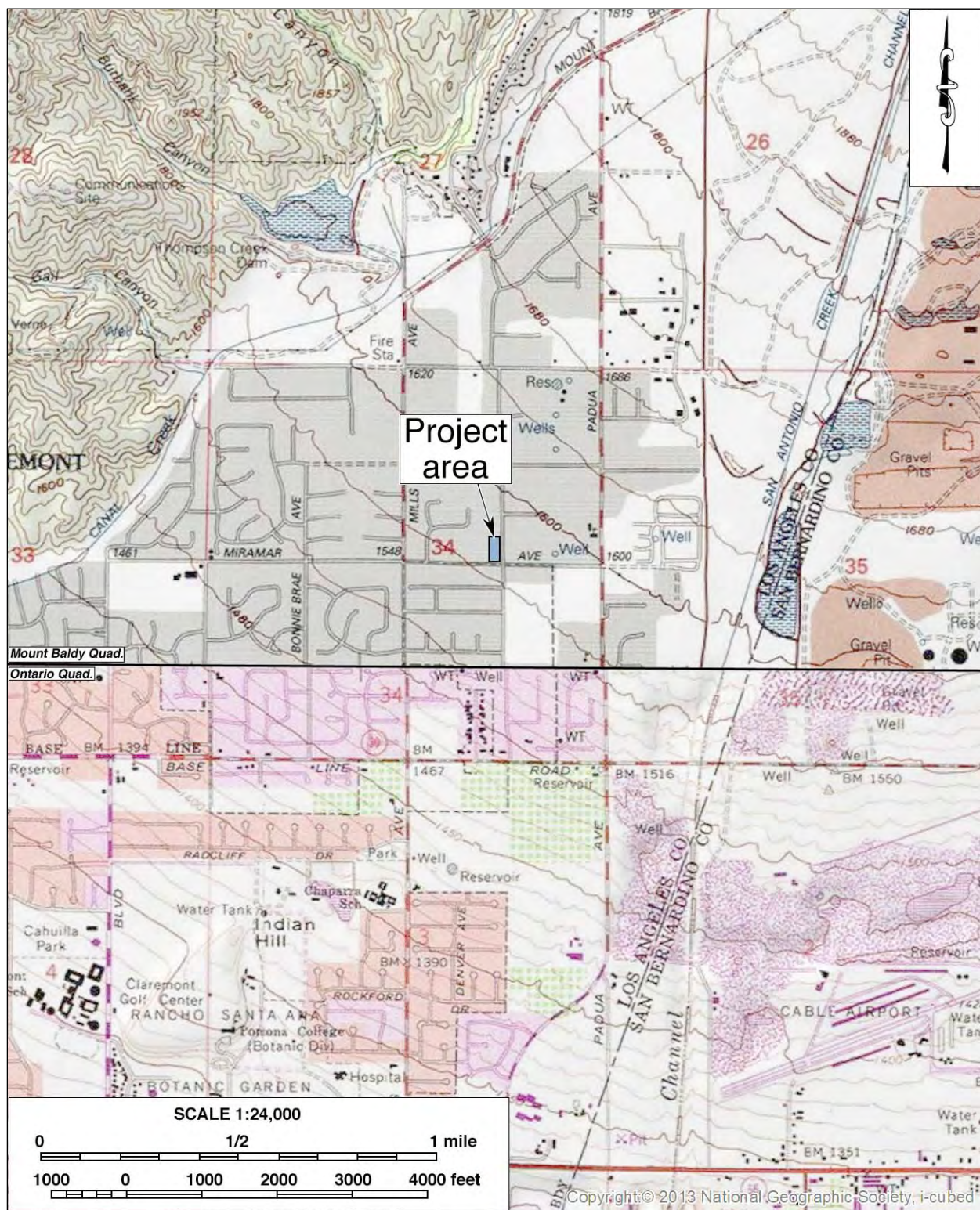

Figure 2. Project location. (Based on USGS Ontario and Mount Baldy, Calif., 7.5' quadrangles [USGS 1980; 1995])

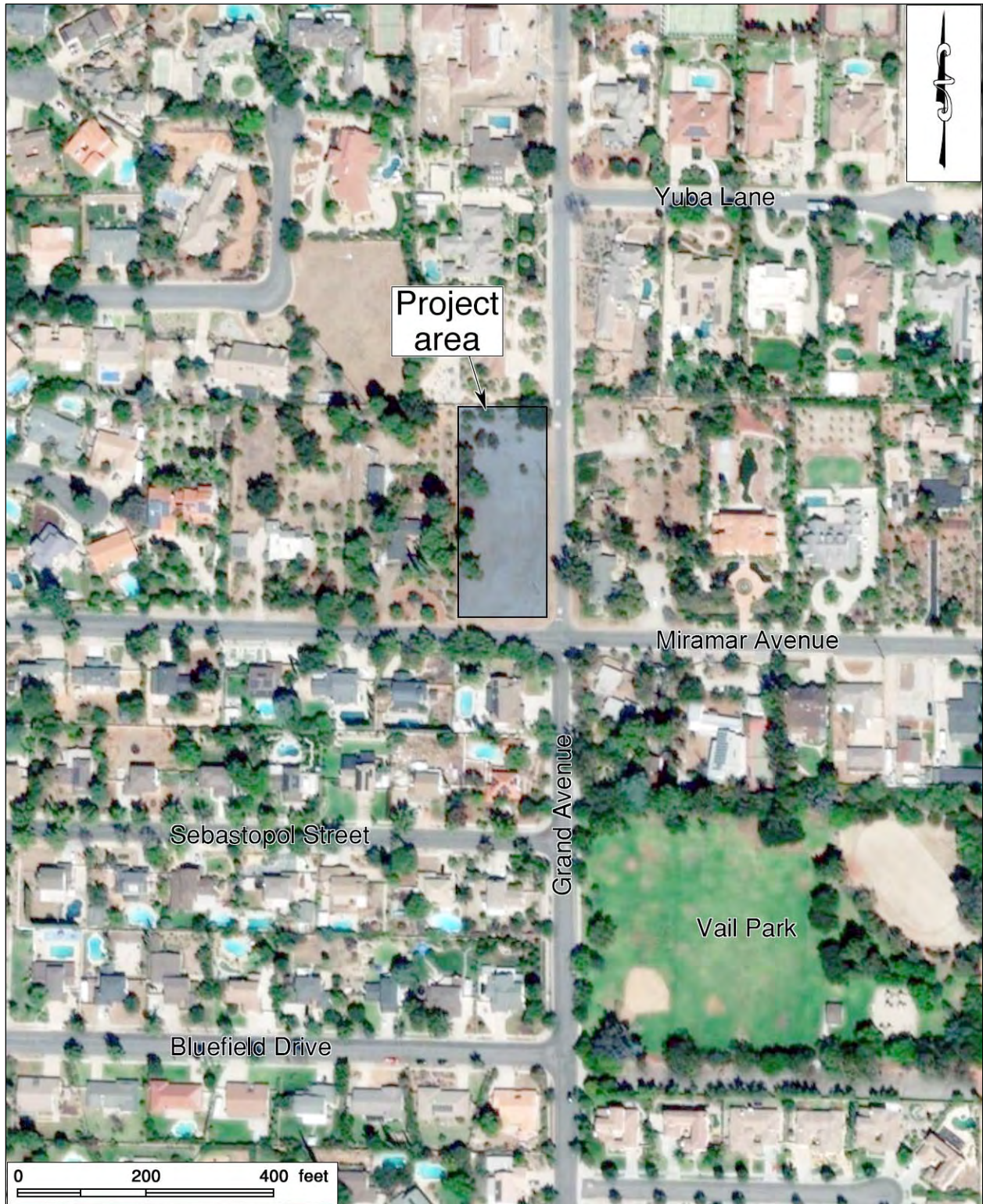

Figure 3. Aerial view of the project area. (Based on Google Earth imagery)

## SETTING

### CURRENT NATURAL SETTING

The City of Claremont is situated in the western portion of the San Bernardino Valley, a broad inland valley defined by the San Gabriel and San Bernardino Mountain Ranges on the north and a series of low rocky hills on the south. It lies on an alluvial fan extending south from the foothills of the mountain ranges, within a floodplain of San Antonio Creek, which is confined within a concrete-lined channel today. The natural environment of the region is characterized by a temperate Mediterranean climate, with seasonal average temperatures ranging between 43 and 91 degrees Fahrenheit. Precipitation is typically less than 15 inches annually, occurring mostly between November and March.

The project area lies approximately one mile southeast of the base of the San Gabriel Mountains and a half-mile west of the San Antonio Creek Channel, at elevations ranging roughly from 1,575 feet to 1,585 feet above mean sea level. The terrain in the project area is relatively level with a slight incline toward the north. The surrounding area, once an agriculture-dominated area on the northern outskirts of Claremont, is now characterized mainly by suburban residential and commercial development (Figure 3).

As of the time of this study, the project area is used as a staging area for a nearby pipeline project, with several large piles of soil, rocks, asphalt, and pipes located near the center of the property and some construction equipment stored along the eastern boundary (Figure 4). The rest of the property is covered by an occasionally dense growth of foxtail, tumbleweed, wild mustard, buckwheat,



Figure 4. Overview of the project area. (Photograph taken on July 29, 2019; view to the north)

cactus, and other small grasses and shrubs, along with a few oak and pine trees. Surface soils in the vicinity are composed of medium brown, fine- to coarse-grained alluvial sands mixed with rocks.

### **CULTURAL SETTING**

#### **Prehistoric Context**

The earliest evidence of human occupation in inland southern California was discovered below the surface of an alluvial fan in the northern portion of the Lakeview Mountains, overlooking the San Jacinto Valley, with radiocarbon dates clustering around 9,500 B.P. (Horne and McDougall 2008). Another site found near the shoreline of Lake Elsinore, close to the confluence of Temescal Wash and the San Jacinto River, yielded radiocarbon dates between 8,000 and 9,000 B.P. (Grenda 1997). Additional sites with isolated Archaic dart points, bifaces, and other associated lithic artifacts from the same age range have been found in the nearby Cajon Pass area, typically atop knolls with good viewsheds (Basgall and True 1985; Goodman and McDonald 2001; Goodman 2002; Milburn et al. 2008).

The cultural history of southern California has been summarized into numerous chronologies, including the works of Chartkoff and Chartkoff (1984), Warren (1984), and others. The prehistory of the inland region specifically has been addressed by O'Connell et al. (1974), McDonald, et al. (1987), Keller and McCarthy (1989), Grenda (1993), Goldberg (2001), and Horne and McDougall (2008). Although the beginning and ending dates of different cultural horizons vary regionally, the general framework of the prehistory of inland southern California can be divided into three primary periods:

- **Paleoindian Period (ca. 18,000-9,000 B.P.):** Native peoples of this period created fluted spearhead bases designed to be hafted to wooden shafts. The distinctive method of thinning bifaces and spearhead preforms by removing long, linear flakes leaves diagnostic Paleoindian markers at tool-making sites. Other artifacts associated with the Paleoindian toolkit include choppers, cutting tools, retouched flakes, and perforators. Sites from this period are very sparse across the landscape and most are deeply buried.
- **Archaic Period (ca. 9,000-1,500 B.P.):** Archaic sites are characterized by abundant lithic scatters of considerable size with many biface thinning flakes, bifacial preforms broken during manufacture, and well-made groundstone bowls and basin metates. As a consequence of making dart points, many biface thinning waste flakes were generated at individual production stations, which is a diagnostic feature of Archaic sites.
- **Late Prehistoric Period (ca. 1,500 B.P.-contact):** Sites from this period typically contain small lithic scatters from the manufacture of small arrow points, expedient groundstone tools such as tabular metates and unshaped manos, wooden mortars with stone pestles, acorn or mesquite bean granaries, ceramic vessels, shell beads suggestive of extensive trading networks, and steatite implements such as pipes and arrow shaft straighteners.

#### **Ethnohistoric Context**

The present-day Clairmont area lies in the eastern portion of the traditional territory of the Gabrielino, a Takic-speaking people considered to be the most populous and most powerful ethnic

group in aboriginal southern California (Bean and Smith 1978:538). The Gabrielino's territory spanned from the San Clemente Island to the San Bernardino-Riverside area and south into southern Orange County, and their influence spread as far as the San Joaquin Valley, the Colorado River, and Baja California. The leading ethnographic sources on Gabrielino culture and history include Bean and Smith (1978), Miller (1991), and McCawley (1996). The following summary is based mainly on these sources.

According to archaeological records, the Gabrielino first arrived in the Los Angeles Basin around 500 B.C., slowly replacing the indigenous Hokan speakers (Howard and Raab 1997; Porcasi 1998). In response to the varying natural environment of their territory, different groups of the Gabrielino adopted different subsistence economies, albeit all based on some combination of gathering, hunting, and/or fishing. In inland areas, the predominant food sources were acorns, sage, deer, and various small animals, including birds. Because of the similarities to other southern California tribes in economic activities, inland Gabrielino groups' industrial arts, dominated by basket weaving, demonstrated no substantial difference from those of their neighbors. Coastal Gabrielino material culture, on the other hand, reflected an elaborately developed artisanship most recognized through the medium of steatite, which was rivaled by few other groups in southern California.

The intricacies of Gabrielino social organization are not well known, although evidence suggests the existence of a moiety system in which various clans belonged to one or the other of two main social/cultural divisions. There also seems to have existed at least three hierarchically ordered social classes, topped with an elite consisting of the chiefs, their immediate families, and the very rich. Some individuals owned land, and property boundaries were marked by the owner's personalized symbol. Villages were politically autonomous, composed of nonlocalized lineages, each with its own leader. The dominant lineage's leader was usually the village chief, whose office was generally hereditary through the male line. Often several villages were allied under the leadership of a single chief. The villages were frequently engaged in warfare against one another, resulting in what some consider to be a state of constant enmity between coastal and inland Gabrielino groups.

As early as 1542, the Gabrielino were in contact with the Spanish during the historic expedition of Juan Rodríguez Cabrillo, but it was not until 1769 that the Spaniards took steps to colonize Gabrielino territory. Shortly afterwards, most of the Gabrielino people were incorporated into Mission San Gabriel and other missions in southern California. Due to introduced diseases, dietary deficiencies, and forceful reduction, Gabrielino population dwindled rapidly. By 1900, they had almost ceased to exist as a culturally identifiable group (Bean and Smith 1978:540). In recent decades, however, there has been a renaissance of Native American activism and cultural revitalization among a number of groups of Gabrielino descendants.

### **Historic Context**

In 1772, three years after the beginning of Spanish colonization of Alta California, Pedro Fages, *comandante* of the new province, and a small force of soldiers under his command became the first Europeans to set foot in the San Bernardino Valley (Beck and Haase 1974:15; Schuiling 1984:23). They were followed in the next few years by two other famed Spanish explorers, Juan Bautista de Anza and Francisco Garcés, who traveled through the valley in the mid-1770s (Beck and Haase 1974:15). Despite these early visits, for the next 40 years the inland valley received little impact

from the Spanish colonization activities in Alta California, which were concentrated predominantly in the coastal regions.

Following the establishment of Mission San Gabriel in 1771, the San Bernardino Valley became nominally a part of the landholdings of that mission. In the 1830s-1840s, during secularization of the mission system, the Mexican authorities in Alta California made a number of large land grants of former mission properties in the valley. However, the area around the project location was not included in any of these land grants, and remained public land when California became a part of the United States in 1848.

Used primarily for cattle ranching, the San Bernardino Valley saw little development until the mid-19th century, when the U.S. annexation brought waves of American immigrants into the once sparsely populated territory. In 1871, W.T. “Tooch” Martin, the first Euroamerican settler in Claremont, filed a 156-acre claim near present-day Indian Hill Boulevard, where he made a living on hunting and bee keeping (City of Claremont n.d.). During the 1880s, the completion of the Santa Fe Railway ended the Southern Pacific Railroad’s monopoly on modern transportation in southern California and brought about a major land boom in the region. Many towns were laid out along the rail lines between San Bernardino and Los Angeles during this time, including Claremont in 1887 (*ibid.*).

A disastrous drought in the 1890s brought an end to the boom and would have emptied many of the newly created towns were it not for the rise of a highly profitable citrus industry. For Claremont, surviving the lean years of the 1890s was also aided by a decision of the local land-holding company to donate its showcase hotel in Claremont and 260 vacant lots to the newly established Pomona College in 1888 (City of Claremont n.d.). The college eventually developed into the Claremont Colleges, a consortium of seven prestigious and highly selective institutions today. The City of Claremont incorporated in 1907, with 73 of its 131 eligible voters approving the measure (*ibid.*). The combination of the thriving citrus industry and the growing college carried the city through the first half of the 20th century until the post-World War II boom.

After the end of World War II, the post-war boom and the completion of Interstate Highway 10 through the area again spurred residential development in Claremont as citrus growers sold their land for housing tracts. Since then, the area’s agrarian character has rapidly given way to a suburban landscape. Aside from hosting the Claremont Colleges, today the City of Claremont also serves as one of the many “bedroom communities” along the major commuter routes in the Inland Empire region in support of the Greater Los Angeles area.

## RESEARCH METHODS

### RECORDS SEARCH

On July 23, 2019, CRM TECH archaeologist Ben Kerridge completed the historical/archaeological resources records search at the South Central Coastal Information Center (SCCIC), California State University, Fullerton. During the records search, Kerridge examined maps, records, and electronic databases at the SCCIC for previously identified cultural resources and existing cultural resources



reports within a one-mile radius of the project area. Previously identified cultural resources include properties designated as California Historical Landmarks, Points of Historical Interest, or San Bernardino County Historical Landmarks, as well as those listed in the National Register of Historic Places, the California Register of Historical Resources, or the California Historical Resources Inventory.

## **NATIVE AMERICAN PARTICIPATION**

On July 8, 2019, CRM TECH submitted a written request to the State of California Native American Heritage Commission (NAHC) for a records search in the commission's Sacred Lands File. Following the NAHC's recommendations and previously established consultation protocol, on July 31 CRM TECH further contacted a total of ten representatives of local tribes in writing for additional information on potential Native American cultural resources in the project vicinity. A complete record of correspondence between CRM TECH and the Native American representatives is attached to this report in Appendix 2.

## **HISTORICAL BACKGROUND RESEARCH**

Historical background research for this study was conducted by CRM TECH principal investigator/historian Bai "Tom" Tang on the basis of published literature in local and regional history, U.S. General Land Office (GLO) land survey plat maps dated 1865, U.S. Geological Survey (USGS) topographic maps dated 1903-1995, and aerial photographs taken in 1938-2018. The historic maps are collected at the Science Library of the University of California, Riverside, and the California Desert District of the U.S. Bureau of Land Management, located in Moreno Valley. The aerial photographs are available at the Nationwide Environmental Title Research (NETR) Online website and through the Google Earth software.

## **FIELD SURVEY**

On July 29, 2019, CRM TECH archaeologist Daniel Ballester carried out the field survey of the project area. The survey was conducted on foot at an intensive level by walking a series of parallel east-west transects spaced 10 meters (approximately 33 feet) apart wherever such regular transects were practicable. Stockpiles of rock and soil prevented the transects in portions of the project area, and these areas were examined as intensively as visibility allowed. In this way, the ground surface in the entire project area was systematically and carefully examined for any evidence of human activities dating to the prehistoric or historic period (i.e., 50 years or older). Except where the stockpiled materials obscured the surface, ground visibility ranged roughly from 50 percent to 100 percent depending on the density of vegetation growth.

## **RESULTS AND FINDINGS**

### **RECORDS SEARCH**

According to SCCIC records, the project area had not been covered by any cultural resources surveys prior to this study, and no cultural resources had been recorded within the project

boundaries. Outside the project area but within a one-mile radius, SCCIC records show at least 15 previous studies on various tracts of land and linear features (Figure 5). Approximately a quarter of the land within the scope of the records search was covered by these studies, resulting in the identification of five historical/archaeological sites within the one-mile radius (see Table 1).

<b>Site Number</b>	<b>Description</b>
19-003747	Prehistoric lithic scatter
19-180639	Claremont Heights Water Company Headquarters Building
19-187085	The Mojave Road
19-188983	The Boulder Dam-Los Angeles 287.5kV Transmission Line
36-015497	San Bernardino Baseline/Baseline Road

One of these sites, 19-003747, was of prehistoric (i.e., Native American) origin. It was recorded more than a half-mile east of the project area and described as a lithic scatter consisting of cores and flakes of obsidian. The other four sites dated to the historic period and included the headquarters buildings of the Claremont Heights Water Company and various linear features of the historical infrastructure. None of these sites was found in the immediate vicinity of the project area, and thus none of them requires further consideration during this study.

## **NATIVE AMERICAN PARTICIPATION**

In response to CRM TECH's inquiry, the NAHC states in a letter dated July 24, 2019, that the Sacred Lands File identified no Native American cultural resource(s) in the project area but recommends that local Native American groups be contacted for further information. For that purpose, the commission provided a list of potential contacts in the region (see Appendix 2). Upon receiving the NAHC's reply, CRM TECH sent written requests for comments to representatives of all nine tribal groups on the referral list (see Appendix 2). For some of the tribes, CRM TECH contacted the designated spokespersons on cultural resources issues in lieu of the individuals recommended by the NAHC, as requested by tribal government staff in the past. In all, ten representatives of the nine tribes were contacted, as listed below:

- Andy Salas, Chairperson, Gabrieleño Band of Mission Indians–Kizh Nation
- Sandonne Goad, Chairperson, Gabrielino/Tongva Nation
- Anthony Morales, Chairperson, Gabrielino/Tongva San Gabriel Band of Mission Indians
- Robert Dorame, Chairperson, Gabrielino Tongva Indians of California Tribal Council
- Charles Alvarez, Chairperson, Gabrielino Tongva Tribe
- Travis Armstrong, Tribal Historic Preservation Officer, Morongo Band of Mission Indians
- Donna Yocum, Chairperson, San Fernando Band of Mission Indians
- Jessica Mauck, Cultural Resources Analyst, San Manuel Band of Mission Indians
- Mark Cochrane, Co-Chairperson, Serrano Nation of Indians
- Wayne Walker, Co-Chairperson, Serrano Nation of Indians

As of this time, two of the nine tribes have responded in writing (see App. 2). Among them, Jessica Mauck of the San Manuel Band indicates that the project area is located within Serrano ancestral territory and near a former village known as *Toibipet*, but the exact location of the village in relation

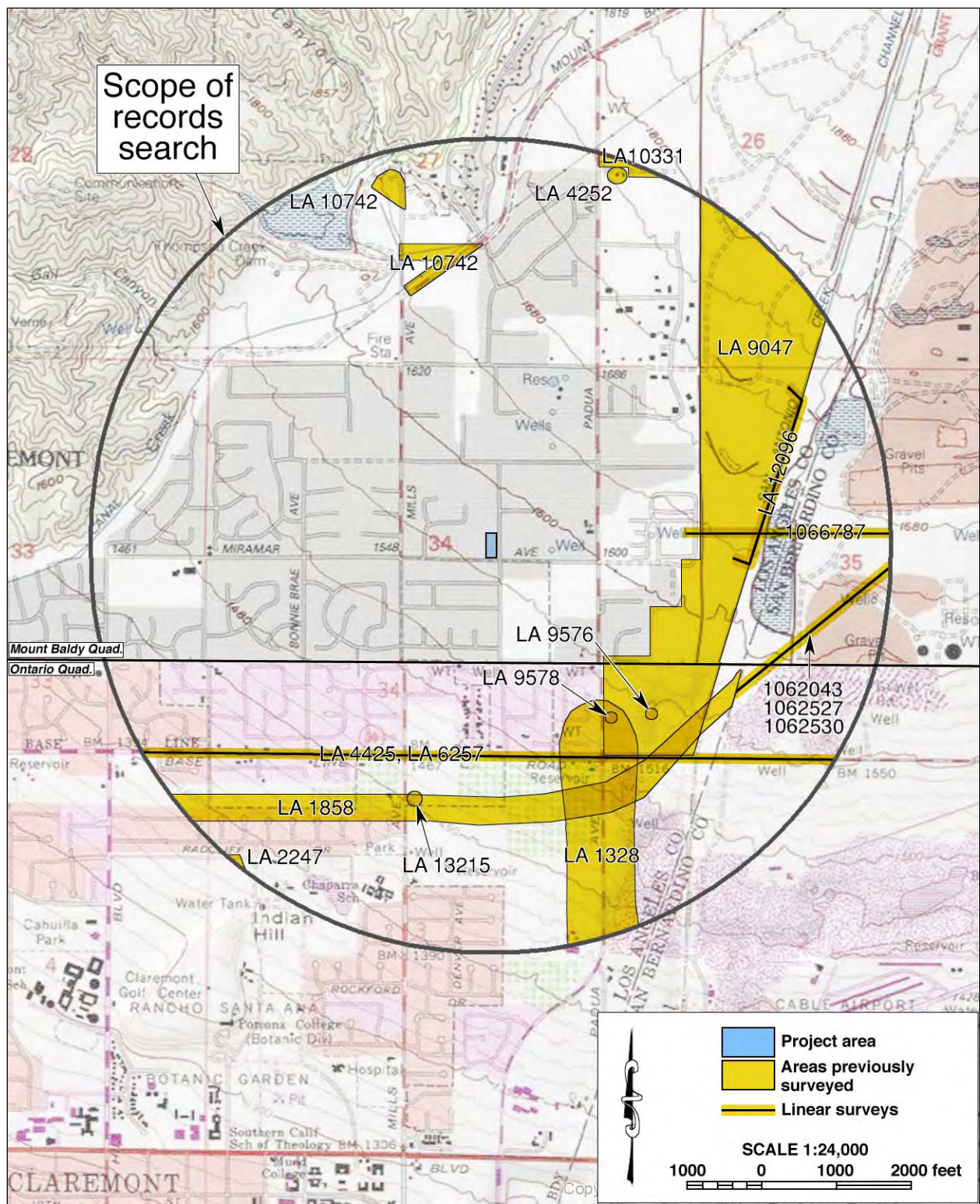

Figure 5. Previous cultural resources studies in the vicinity of the project area, listed by SCCIC file number. Locations of historical/archaeological sites are not shown as a protective measure.

to the project area is not clear to the tribe. Ms. Mauck states that the information provided in this study may help the tribe during further consultation with TVMWD. Travis Armstrong of the Morongo Band states that the tribe has no information to provide at this time but may provide other information to the TVMWD future consultation.

### HISTORICAL BACKGROUND RESEARCH

Historical sources consulted for this study indicate no man-made features within the project boundaries in the 1850s-1890s era and show the property to be under agricultural use from at least the 1930s to the 1990s (Figures 6-9; NETR Online 1938-1989; Google Earth 1989; 1994). In the 1930s-1950s, the northern portion of Claremont was predominantly occupied by expansive orchards, most likely citrus groves (Figure 8; NETR Online 1938-1959). In the mid-1960s, suburban residential development began to appear on nearby properties, but the grove in the project area survived well into the 1990s, when much of the surrounding area had been suburbanized (NETR Online 1964-1989; Google Earth 1989; 1994). The trees of the grove were gradually removed over the next few years, but the land has been left undeveloped to the present time (NETR Online 2002-2016; Google Earth 2002-2018).

### FIELD SURVEY

The field survey produced completely negative results, and no sites, features, or artifact deposits of prehistoric or historic origin were found. The ground surface in the project area has been extensively disturbed from both past agricultural operations and its recent use as a storage area for construction equipment and materials (Figure 4).

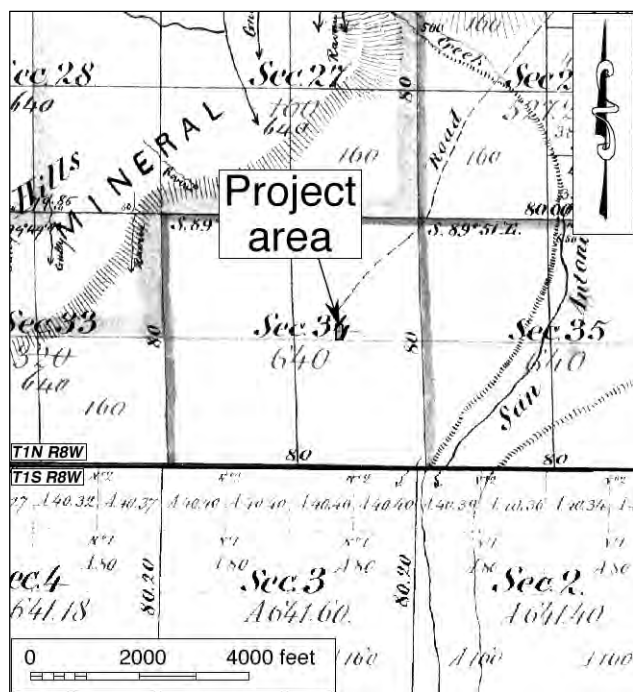

Figure 6. The project area and vicinity in 1852-1865 (Source: GLO 1865a; 1865b)

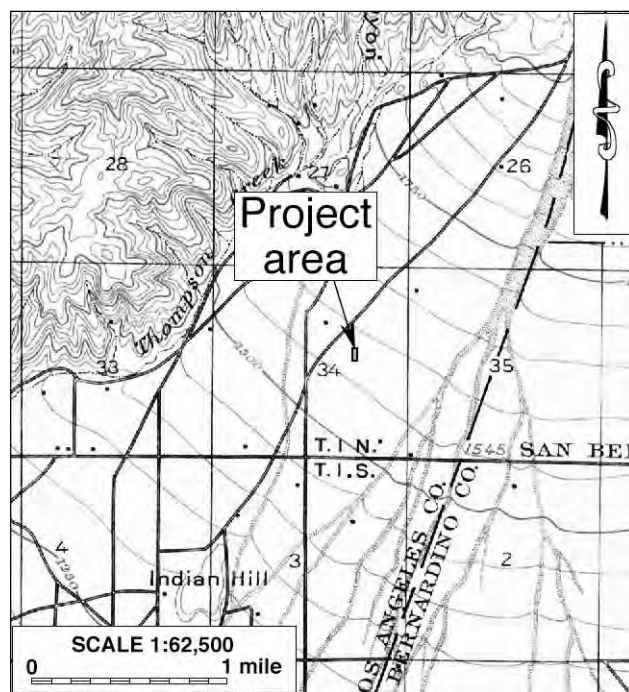

Figure 7. The project area and vicinity in 1894 (Source: USGS 1903)



Figure 8. The project area and vicinity in 1952-1953.  
(Source: USGS 1954a; 1954b)

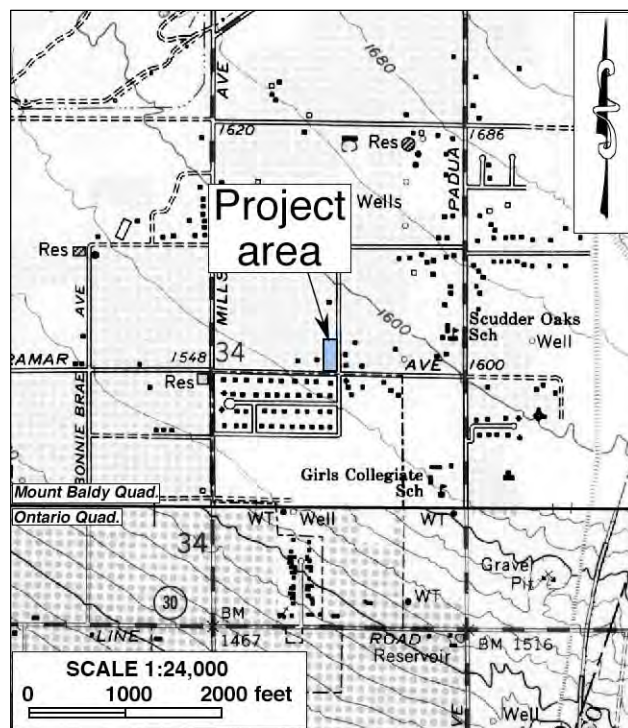

Figure 9. The project area and vicinity in 1966-1967.  
(Source: USGS 1967a; 1967b)

## DISCUSSION

The purpose of this study is to identify any cultural resources within the project area and assist the TVMWD in determining whether such resources meet the official definition of “historical resources,” as provided in the California Public Resources Code, in particular CEQA. According to PRC §5020.1(j), “‘historical resource’ includes, but is not limited to, any object, building, site, area, place, record, or manuscript which is historically or archaeologically significant, or is significant in the architectural, engineering, scientific, economic, agricultural, educational, social, political, military, or cultural annals of California.”

More specifically, CEQA guidelines state that the term “historical resources” applies to any such resources listed in or determined to be eligible for listing in the California Register of Historical Resources, included in a local register of historical resources, or determined to be historically significant by the lead agency (Title 14 CCR §15064.5(a)(1)-(3)). Regarding the proper criteria for the evaluation of historical significance, CEQA guidelines mandate that “generally a resource shall be considered by the lead agency to be ‘historically significant’ if the resource meets the criteria for listing on the California Register of Historical Resources” (Title 14 CCR §15064.5(a)(3)). A resource may be listed in the California Register if it meets any of the following criteria:

- (1) Is associated with events that have made a significant contribution to the broad patterns of California’s history and cultural heritage.
- (2) Is associated with the lives of persons important in our past.

- (3) Embodies the distinctive characteristics of a type, period, region, or method of construction, or represents the work of an important creative individual, or possesses high artistic values.
- (4) Has yielded, or may be likely to yield, information important in prehistory or history. (PRC §5024.1(c))

In summary of the research results presented above, no potential “historical resources” were previously recorded within or adjacent to the project area, and none was identified during the present survey. No notable man-made features were observed on the property throughout the historic period, and Native American input received during this study identified no properties of traditional cultural value at this location. Furthermore, the ground surface in the project area has been extensively disturbed, leaving little vestige of the native landscape. Based on these findings, and in light of the criteria listed above, the present study concludes that no “historical resources” exist within or adjacent to the project area.

### CONCLUSION AND RECOMMENDATIONS

CEQA establishes that “a project that may cause a substantial adverse change in the significance of a historical resource is a project that may have a significant effect on the environment” (PRC §21084.1). “Substantial adverse change,” according to PRC §5020.1(q), “means demolition, destruction, relocation, or alteration such that the significance of a historical resource would be impaired.”

As stated above, no “historical resources,” as defined by CEQA, were encountered throughout the course of this study. Therefore, CRM TECH presents the following recommendations to TVMWD:

- No “historical resources” exist within or adjacent to the project area, and thus the project as currently proposed will not cause a substantial adverse change to any known “historical resources.”
- No further cultural resources investigation is necessary for the proposed project unless construction plans undergo such changes as to include areas not covered by this study.
- If buried cultural materials are encountered during any earth-moving operations associated with the project, all work within 50 feet of the discovery should be halted or diverted until a qualified archaeologist can evaluate the nature and significance of the finds.

### REFERENCES

- Basgall, Mark E., and D.L. True  
1985 Archaeological Investigations in Crowder Canyon, 1973-1984: Excavations at Sites SBR-421B, SBR-421C, SBR-421D, and SBR-713, San Bernardino County, California. On file, South Central Coastal Information Center, California State University, Fullerton.
- Bean, Lowell John, and Charles R. Smith  
1978 Gabriellino. In Robert F. Heizer (ed.): *Handbook of North American Indians*, Vol. 8: *California*; pp. 538-549. Smithsonian Institution, Washington, D.C.
- Beck, Warren A., and Ynez D. Haase  
1974 *Historical Atlas of California*. University of Oklahoma Press, Norman.

- Chartkoff, Joseph L., and Kerry Kona Chartkoff  
 1984 *The Archaeology of California*. Stanford University Press, Palo Alto, California.
- City of Claremont  
 n.d. History of Claremont. <https://www.ci.claremont.ca.us/about-us/city-profile/history-of-claremont>.
- GLO (General Land Office, U.S. Department of the Interior)  
 1865a Plat Map: Township No. 1 North Range No. 8 West, SBBM; surveyed in 1852-1865.  
 1865b Plat Map: Township No. 1 South Range No. 8 West, SBBM; surveyed in 1852-1865.
- Goldberg, Susan K. (ed.)  
 2001 Metropolitan Water District of Southern California Eastside Reservoir Project: Final Report of Archaeological Investigations. On file, Eastern information Center, University of California, Riverside.
- Goodman, John D., II  
 2002 Archaeological Survey of the Charter Communications Cable Project, Mountaintop Ranger District, San Bernardino National Forest, California. San Bernardino National Forest Technical Report 05-12-BB-102.
- Goodman, John D., II, and M. McDonald  
 2001 Archaeological Survey of the Southern California Trials Association Event Area, Little Pine Flats, Mountaintop Ranger District, San Bernardino National Forest, California. San Bernardino National Forest Technical Report 05-12-BB-106.
- Google Earth  
 1989-2018 Aerial photographs of the project vicinity; taken in 1989, 1994, 2002-2009, 2011, and 2013-2018. Available through the Google Earth software.
- Grenda, Donn  
 1993 Archaeological Treatment Plan for CA-RIV-2798/H, Lake Elsinore, Riverside County, California. On file, Eastern Information Center, University of California, Riverside.  
 1997 Continuity and Change: 8,500 Years of Lacustrine Adaptation on the Shores of Lake Elsinore. Statistical Research Technical Series 59. Statistical Research, Inc., Tucson, Arizona.
- Horne, Melinda C., and Dennis P. McDougall  
 2008 CA-RIV-6069: Early Archaic Settlement and Subsistence in the San Jacinto Valley, Western Riverside County, California. On file, Eastern Information Center, University of California, Riverside.
- Howard, W.J., and L.M. Raab  
 1993 Olivella Grooved Rectangle Beads as Evidence of an Early Period Southern California Channel Island Interaction Sphere. *Pacific Coast Archaeological Society Quarterly* 29(3):1-11.
- Keller, Jean S., and Daniel F. McCarthy  
 1989 Data Recovery at the Cole Canyon Site (CA-RIV-1139), Riverside County, California. *Pacific Coast Archeological Society Quarterly* 25.
- McCawley, William  
 1996 *The First Angelinos: The Gabrielino Indians of Los Angeles*. Malki Museum Press/Ballena Press, Banning/Novato, California.
- McDonald, Meg, Philip J. Wilke, and Andrea Kauss  
 1987 McCue: An Elko Site in Riverside County. *Journal of California and Great Basin Anthropology* 9(1):46-73.

- Milburn, Doug, U.K. Doan, and John D. Goodman II  
2008 Archaeological Investigation at Baldy Mesa-Cajon Divide for the Baldy Mesa Off-Highway-Vehicle Recreation Trails Project, San Bernardino National Forest, San Bernardino County, California. San Bernardino National Forest Technical Report 05-12-53-091.
- Miller, Bruce W.  
1991 *The Gabrielino*. Sand River Press, Los Osos, California.
- NETR Online  
1938-2016 Aerial photographs of the project vicinity; taken in 1938, 1948, 1953, 1959, 1964-1966, 1972, 1979-1980, 1989, 2002-2003, 2005, 2009, 2010, 2012, 2014, and 2016.  
<http://www.historicaerials.com>.
- O'Connell, James F., Philip J. Wilke, Thomas F. King, and Carol L. Mix (eds.)  
1974 Perris Reservoir Archaeology: Late Prehistoric Demographic Change in Southeastern California. On file, Eastern Information Center, University of California, Riverside.
- Porcasi, Judith F.  
1998 Middle Holocene Ceramic Technology on the Southern California Coast: New Evidence from Little Harbor, Santa Catalina Island. *Journal of California and Great Basin Anthropology* 20:270-284.
- Schuiling, Walter C.  
1984 *San Bernardino County: Land of Contrasts*. Windsor Publications, Woodland Hills, California.
- USGS (United States Geological Survey, U.S. Department of the Interior)  
1903 Map: Cucamonga, Calif. (15', 1:62,500); surveyed in 1894.  
1954a Map: Mount Baldy, Calif. (15', 1:62,500); aerial photographs taken in 1952.  
1954b Map: Ontario, Calif. (15', 1:62,500); aerial photographs taken in 1952.  
1967a Map: Mount Baldy, Calif. (7.5', 1:24,000); aerial photographs taken in 1966, field-checked in 1967.  
1967b Map: Ontario, Calif. (7.5', 1:24,000); aerial photographs taken in 1966, field-checked in 1967.  
1969 Map: San Bernardino, Calif. (1:250,000); 1958 edition revised.  
1981 Map: Ontario, Calif. (7.5', 1:24,000); 1967 edition photorevised in 1981.  
1995 Map: Mount Baldy, Calif. (7.5', 1:24,000); 1988 edition revised in 1995.
- Warren, Claude N.  
1984 The Desert Region. In Michael J. Moratto (ed.): *California Archaeology*; pp. 339-430. Academic Press, Orlando, Florida.



**APPENDIX 1:  
PERSONNEL QUALIFICATIONS**

**PRINCIPAL INVESTIGATOR/HISTORIAN  
Bai “Tom” Tang, M.A.**

**Education**

- 1988-1993 Graduate Program in Public History/Historic Preservation, UC Riverside.  
 1987 M.A., American History, Yale University, New Haven, Connecticut.  
 1982 B.A., History, Northwestern University, Xi’an, China.
- 2000 “Introduction to Section 106 Review,” presented by the Advisory Council on Historic Preservation and the University of Nevada, Reno.  
 1994 “Assessing the Significance of Historic Archaeological Sites,” presented by the Historic Preservation Program, University of Nevada, Reno.

**Professional Experience**

- 2002- Principal Investigator, CRM TECH, Riverside/Colton, California.  
 1993-2002 Project Historian/Architectural Historian, CRM TECH, Riverside, California.  
 1993-1997 Project Historian, Greenwood and Associates, Pacific Palisades, California.  
 1991-1993 Project Historian, Archaeological Research Unit, UC Riverside.  
 1990 Intern Researcher, California State Office of Historic Preservation, Sacramento.  
 1990-1992 Teaching Assistant, History of Modern World, UC Riverside.  
 1988-1993 Research Assistant, American Social History, UC Riverside.  
 1985-1988 Research Assistant, Modern Chinese History, Yale University.  
 1985-1986 Teaching Assistant, Modern Chinese History, Yale University.  
 1982-1985 Lecturer, History, Xi’an Foreign Languages Institute, Xi’an, China.

**Cultural Resources Management Reports**

Preliminary Analyses and Recommendations Regarding California’s Cultural Resources Inventory System (with Special Reference to Condition 14 of NPS 1990 Program Review Report). California State Office of Historic Preservation working paper, Sacramento, September 1990.

Numerous cultural resources management reports with the Archaeological Research Unit, Greenwood and Associates, and CRM TECH, since October 1991.

**PRINCIPAL INVESTIGATOR/ARCHAEOLOGIST**

**Michael Hogan, Ph.D., RPA\***

**Education**

- 1991 Ph.D., Anthropology, University of California, Riverside.  
1981 B.S., Anthropology, University of California, Riverside; with honors.  
1980-1981 Education Abroad Program, Lima, Peru.
- 2002 Section 106—National Historic Preservation Act: Federal Law at the Local Level.  
UCLA Extension Course #888.
- 2002 “Recognizing Historic Artifacts,” workshop presented by Richard Norwood,  
Historical Archaeologist.
- 2002 “Wending Your Way through the Regulatory Maze,” symposium presented by the  
Association of Environmental Professionals.
- 1992 “Southern California Ceramics Workshop,” presented by Jerry Schaefer.  
1992 “Historic Artifact Workshop,” presented by Anne Duffield-Stoll.

**Professional Experience**

- 2002- Principal Investigator, CRM TECH, Riverside/Colton, California.  
1999-2002 Project Archaeologist/Field Director, CRM TECH, Riverside.  
1996-1998 Project Director and Ethnographer, Statistical Research, Inc., Redlands.  
1992-1998 Assistant Research Anthropologist, University of California, Riverside  
1992-1995 Project Director, Archaeological Research Unit, U. C. Riverside.  
1993-1994 Adjunct Professor, Riverside Community College, Mt. San Jacinto College, U.C.  
Riverside, Chapman University, and San Bernardino Valley College.  
1991-1992 Crew Chief, Archaeological Research Unit, U. C. Riverside.  
1984-1998 Archaeological Technician, Field Director, and Project Director for various southern  
California cultural resources management firms.

**Research Interests**

Cultural Resource Management, Southern Californian Archaeology, Settlement and Exchange  
Patterns, Specialization and Stratification, Culture Change, Native American Culture, Cultural  
Diversity.

**Cultural Resources Management Reports**

Author and co-author of, contributor to, and principal investigator for numerous cultural resources  
management study reports since 1986.

**Memberships**

\* Register of Professional Archaeologists; Society for American Archaeology; Society for California  
Archaeology; Pacific Coast Archaeological Society; Coachella Valley Archaeological Society.

**ARCHAEOLOGIST/FIELD DIRECTOR**  
**Daniel Ballester, M.S.**

**Education**

- 2013 M.S., Geographic Information System (GIS), University of Redlands, California.  
1998 B.A., Anthropology, California State University, San Bernardino.  
1997 Archaeological Field School, University of Las Vegas and University of California, Riverside.  
1994 University of Puerto Rico, Rio Piedras, Puerto Rico.

**Professional Experience**

- 2002- Field Director/GIS Specialist, CRM TECH, Riverside/Colton, California.  
2011-2012 GIS Specialist for Caltrans District 8 Project, Garcia and Associates, San Anselmo, California.  
2009-2010 Field Crew Chief, Garcia and Associates, San Anselmo, California.  
2009-2010 Field Crew, ECorp, Redlands.  
1999-2002 Project Archaeologist, CRM TECH, Riverside, California.  
1998-1999 Field Crew, K.E.A. Environmental, San Diego, California.  
1998 Field Crew, A.S.M. Affiliates, Encinitas, California.  
1998 Field Crew, Archaeological Research Unit, University of California, Riverside.

**PROJECT ARCHAEOLOGIST/NATIVE AMERICAN LIAISON**  
**Nina Gallardo, B.A.**

**Education**

- 2004 B.A., Anthropology/Law and Society, University of California, Riverside.

**Professional Experience**

- 2004- Project Archaeologist, CRM TECH, Riverside/Colton, California.

**Cultural Resources Management Reports**

Co-author of and contributor to numerous cultural resources management reports since 2004.

**PROJECT ARCHAEOLOGIST/REPORT WRITER**  
**Ben Kerridge, M.A.**

**Education**

- 2014 Archaeological Field School, Institute for Field Research, Kephallenia, Greece.  
2010 M.A., Anthropology, California State University, Fullerton.  
2009 Project Management Training, Project Management Institute/CH2M HILL, Santa Ana, California.  
2004 B.A., Anthropology, California State University, Fullerton.

**Professional Experience**

- 2015- Project Archaeologist/Report Writer, CRM TECH, Colton, California.  
2015 Teaching Assistant, Institute for Field Research, Kephallenia, Greece.  
2009-2014 Publications Delivery Manager, CH2M HILL, Santa Ana, California.  
2010- Naturalist, Newport Bay Conservancy, Newport Beach, California.  
2006-2009 Technical Publishing Specialist, CH2M HILL, Santa Ana, California.  
2002-2006 English Composition/College Preparation Tutor, various locations, California.

**Papers Presented**

- Geomorphological Survey of Tracts T126–T151 to Support Archaeological Shoreline Research Project. Institute for Field Research, Kephallenia, Greece, 2014.
- The Uncanny Valley of the Shadow of Modernity: A Re-examination of Anthropological Approaches to Christianity. Graduate Thesis, California State University, Fullerton, 2010.
- Ethnographic Endeavors into the World of Counterstrike. 74th Annual Conference of the Southwestern Anthropological Association, 2003.

**Cultural Resources Management Reports**

Co-author and contributor to numerous cultural resources management reports since 2013.

**Memberships**

Society for California Archaeology; Pacific Coast Archaeological Society.

**APPENDIX 2**

**CORRESPONDENCE WITH  
NATIVE AMERICAN REPRESENTATIVES\***

---

\* Ten local Native American representatives were contacted; a sample letter is included in this report.

**SACRED LANDS FILE & NATIVE AMERICAN CONTACTS LIST REQUEST**

**NATIVE AMERICAN HERITAGE COMMISSION**

1550 Harbor Boulevard, Suite 100  
West Sacramento, CA 95691  
(916)373-3710  
(916)373-5471 (Fax)  
nahc@nahc.ca.gov

**Project:** Proposed Three Valleys Municipal Water District Well No. 4 Project; Assessor's Parcel Number 8671-009-019 (CRM TECH No. 3513)

**County:** Los Angeles

**USGS Quadrangle Name:** Mount Baldy and Ontario, Calif.

**Township** 1 North **Range** 8 West **SB BM; Section(s):** 34

**Company/Firm/Agency:** CRM TECH

**Contact Person:** Nina Gallardo

**Street Address:** 1016 E. Cooley Drive, Suite A/B

**City:** Colton, CA **Zip:** 92324

**Phone:** (909) 824-6400 **Fax:** (909) 824-6405

**Email:** ngallardo@crmtech.us

**Project Description:** The primary component of the project is to construct a new well on approximately one acre of vacant land in Assessor's Parcel Number 8671-009-019, located on the northwest corner of Grand Avenue and Miramar Avenue, in the City of Claremont, Los Angeles County, California.

*July 8, 2019*



**Native American Heritage Commission  
Native American Contact List  
Los Angeles County  
7/24/2019**

**Item 9 - Exhibit B**

**Gabrieleno Band of Mission Indians - Kizh Nation**

Andrew Salas, Chairperson  
P.O. Box 393  
Covina, CA, 91723  
Phone: (626) 926 - 4131  
admin@gabrielenoindians.org

Gabrieleno

**Morongo Band of Mission Indians**

Robert Martin, Chairperson  
12700 Pumarra Rroad  
Banning, CA, 92220  
Phone: (951) 849 - 8807  
Fax: (951) 922-8146  
dtorres@morongo-nsn.gov

Cahuilla  
Serrano

**Gabrieleno/Tongva San Gabriel Band of Mission Indians**

Anthony Morales, Chairperson  
P.O. Box 693  
San Gabriel, CA, 91778  
Phone: (626) 483 - 3564  
Fax: (626) 286-1262  
GTTribalcouncil@aol.com

Gabrieleno

**San Fernando Band of Mission Indians**

Donna Yocum, Chairperson  
P.O. Box 221838  
Newhall, CA, 91322  
Phone: (503) 539 - 0933  
Fax: (503) 574-3308  
ddyocum@comcast.net

Kitanemuk  
Vanyume  
Tataviam

**Gabrielino /Tongva Nation**

Sandonne Goad, Chairperson  
106 1/2 Judge John Aiso St.,  
#231  
Los Angeles, CA, 90012  
Phone: (951) 807 - 0479  
sgoad@gabrielino-tongva.com

Gabrielino

**San Manuel Band of Mission Indians**

Lee Clauss, Director of Cultural Resources  
26569 Community Center Drive  
Highland, CA, 92346  
Phone: (909) 864 - 8933  
Fax: (909) 864-3370  
lclauss@sanmanuel-nsn.gov

Serrano

**Gabrielino Tongva Indians of California Tribal Council**

Robert Dorame, Chairperson  
P.O. Box 490  
Bellflower, CA, 90707  
Phone: (562) 761 - 6417  
Fax: (562) 761-6417  
gtongva@gmail.com

Gabrielino

**Serrano Nation of Mission Indians**

Mark Cochrane, Co-Chairperson  
P. O. Box 343  
Patton, CA, 92369  
Phone: (909) 528 - 9032  
serranonation1@gmail.com

Serrano

**Gabrielino-Tongva Tribe**

Charles Alvarez,  
23454 Vanowen Street  
West Hills, CA, 91307  
Phone: (310) 403 - 6048  
roadkingcharles@aol.com

Gabrielino

**Serrano Nation of Mission Indians**

Wayne Walker, Co-Chairperson  
P. O. Box 343  
Patton, CA, 92369  
Phone: (253) 370 - 0167  
serranonation1@gmail.com

Serrano

**Morongo Band of Mission Indians**

Denisa Torres, Cultural Resources Manager  
12700 Pumarra Rroad  
Banning, CA, 92220  
Phone: (951) 849 - 8807  
Fax: (951) 922-8146  
dtorres@morongo-nsn.gov

Cahuilla  
Serrano

This list is current only as of the date of this document. Distribution of this list does not relieve any person of statutory responsibility as defined in Section 7050.5 of the Health and Safety Code, Section 5097.94 of the Public Resource Section 5097.98 of the Public Resources Code.

This list is only applicable for contacting local Native Americans with regard to cultural resources assessment for the proposed Three Valleys Municipal Water District Well No. 4 Project, Los Angeles County.



July 31, 2019

Sandonne Goad, Chairperson  
Gabrielino/Tongva Nation  
P.O. Box 86908  
Los Angeles, CA 90086

RE: Proposed Three Valleys Municipal Water District Well No. 4 Project  
Assessor's Parcel Number 8671-009-019  
One Acre in the City of Claremont, Los Angeles County, California  
CRM TECH Contract #3513

Dear Ms. Goad:

I am writing to bring your attention to an ongoing CEQA-compliance study for the proposed project referenced above. The project entails the construction of a new well on approximately one acre of land in APN 8671-009-019, located on the northwest corner of Grand Avenue and Miramar Avenue, in the City of Claremont. The accompanying map, based on USGS Mount Baldy and Ontario, Calif., 7.5' quadrangles, depicts the location of the project area in Section 34, T1N R8W, SBBM.

In a letter dated July 24, 2019, the Native American Heritage Commission reports that the Sacred Lands File search was negative but recommends that local Native American groups be contacted for further information (see attached). Therefore, as part of the cultural resources study for this project, I am writing to request your input on potential Native American cultural resources in or near the project area.

Please respond at your earliest convenience if you have any specific knowledge of sacred/religious sites or other sites of Native American traditional cultural value in or near the project area, or any other information to consider during the cultural resources investigations. Any information or concerns may be forwarded to CRM TECH by telephone, e-mail, facsimile, or standard mail. Requests for documentation or information we cannot provide will be forwarded to our client and/or the lead agency, namely the Three Valleys Municipal Water District (TVMWD).

We would also like to clarify that, as the cultural resources consultant for the project, CRM TECH is not involved in the AB 52-compliance process or in government-to-government consultations. The purpose of this letter is to seek any information that you may have to help us determine if there are cultural resources in or near the project area that we should be aware of and to help us assess the sensitivity of the project area. Thank you for your time and effort in addressing this important matter.

Respectfully,

Nina Gallardo  
Project Archaeologist/Native American liaison  
CRM TECH  
Email: [ngallardo@crmtech.us](mailto:ngallardo@crmtech.us)

**From:** Jessica Mauck <JMauck@sanmanuel-nsn.gov>  
**Sent:** Wednesday, July 31, 2019 5:32 PM  
**To:** ngallardo@crmtech.us  
**Subject:** RE: NA Scoping Letter for the Proposed Three Valleys Municipal Water District Well No. 4 Project, APN 8671-009-019, in the City of Claremont, Los Angeles County (CRM TECH #3513)

Hi Nina,

Thank you for contacting the San Manuel Band of Mission Indians (SMBMI) concerning the above-referenced project. This project is just within the southwesternmost border of Serrano ancestral territory, and is located within 1 mile of the approximate location of the village of Toibipet. Unfortunately, we do not have any archaeological data on file for this area, so we have been unable to cross-reference with the ethnographic data that speaks about the village. As such, we have a low understanding of exactly where this village is located in relation to the proposed project area. The information CRM Tech provides within the report will be very helpful in assisting SMBMI during consultation with the lead agency.

Sincerely,

Jessica Mauck  
CULTURAL RESOURCES ANALYST  
O: (909) 864-8933 x3249  
M: (909) 725-9054  
26569 Community Center Drive  
Highland California 92346

---

**From:** Tribal Historic Preservation Office <thpo@morongo-nsn.gov>  
**Sent:** Friday, August 2, 2019 3:16 PM  
**To:** 'ngallardo@crmtech.us'  
**Subject:** RE: NA Scoping Letter for the Proposed Three Valleys Municipal Water District Well No. 4 Project, APN 8671-009-019, in the City of Claremont, Los Angeles County (CRM TECH #3513)

Hello,

Regarding the above referenced project, we have no additional information to provide at this time but may provide other information to the lead agency during the AB 52 consultation process.

Thank you for reaching out to our office.

Sincerely,

Travis Armstrong  
Tribal Historic Preservation Officer  
Morongo Band of Mission Indians  
951-755-5259 / Email: thpo@morongo-nsn.gov

APPENDIX C  
NOISE IMPACT STUDY

# Miragrand Well

## Noise Impact Study

### City of Claremont, CA

Prepared for:

Ms. Nancy Ferguson

**Jericho Systems, Inc.**

47 1<sup>st</sup> Street, Suite 1

Redlands, CA 92373-4601

Prepared by:

**MD Acoustics LLC**

Mike Dickerson, INCE

Claire Pincock

1197 Los Angeles Ave, Ste C-256

Simi Valley, CA 93065

Date: 9/11/2019



---

Noise Study Reports | Vibration Studies | Air Quality | Greenhouse Gas | Health Risk Assessments

P) AZ - 602.774.1950

P) CA - 805.426.4477

[www.mdacoustics.com](http://www.mdacoustics.com)  
[info@mdacoustics.com](mailto:info@mdacoustics.com)

**TABLE OF CONTENTS**

- 1.0 Introduction ..... 1
  - 1.1 Purpose of Analysis and Study Objectives ..... 1
  - 1.2 Project Purpose and Overview ..... 1
  - 1.3 Site Location and Study Area ..... 2
  - 1.4 Proposed Project Description ..... 2
- 2.0 Fundamentals of Noise ..... 5
  - 2.1 Sound, Noise and Acoustics ..... 5
  - 2.2 Frequency and Hertz ..... 5
  - 2.3 Sound Pressure Levels and Decibels ..... 5
  - 2.4 Addition of Decibels ..... 5
  - 2.5 Human Response to Changes in Noise Levels ..... 6
  - 2.6 Noise Descriptors ..... 6
  - 2.7 Traffic Noise Prediction ..... 8
  - 2.8 Sound Propagation ..... 8
- 3.0 Ground-Borne Vibration Fundamentals ..... 10
  - 3.1 Vibration Descriptors ..... 10
  - 3.2 Vibration Perception ..... 10
  - 3.3 Vibration Perception ..... 10
- 4.0 Regulatory Setting ..... 12
  - 4.1 Federal Regulations ..... 12
  - 4.2 State Regulations ..... 12
  - 4.3 City of Claremont Noise Regulations ..... 13
- 5.0 Study Method and Procedure ..... 17
  - 5.1 Noise Measurement Procedure and Criteria ..... 17
  - 5.2 Noise Measurement Locations ..... 17
  - 5.3 Operational Stationary Noise Modeling ..... 17
  - 5.4 FHWA Roadway Construction Noise Model ..... 18
- 6.0 Existing Noise Environment ..... 20
  - 6.1 Noise Measurement Results ..... 20
- 7.0 Future Noise Environment Impacts and Mitigation ..... 22
  - 7.1 Future Exterior Noise ..... 22
    - 7.1.1 Stationary Source Noise ..... 22
- 8.0 Construction Noise Impact ..... 24
  - 8.1 Construction Noise ..... 24
  - 8.2 Construction Vibration ..... 26
  - 8.3 Construction Design Noise Reduction Measures ..... 26
- 9.0 References ..... 29

**LIST OF APPENDICES**

Appendix A: Photographs and Field Measurement Data..... 1

Appendix B: Well Motor Noise Measurements ..... 2

Appendix C: Construction Calculations ..... 3

Appendix D: Vibration Calculations ..... 4

**LIST OF EXHIBITS**

Exhibit A: Location Map ..... 3

Exhibit B: Site Plan..... 4

Exhibit C: Typical A-Weighted Noise Levels ..... 5

Exhibit D: Land Use Compatibility Guidelines ..... 13

Exhibit E: Measurement Locations ..... 19

Exhibit F: Proposed Well Pump Enclosure..... 23

Exhibit G: Proposed Sound Wall Layout..... 28

**LIST OF TABLES**

Table 1: Allowable Exterior Noise Level<sup>1</sup> ..... 14

Table 2: Long-Term Noise Measurement Data<sup>1</sup> ..... 20

Table 3: CA/T Equipment Noise Emissions and Acoustical Usage Factor Database..... 24

Table 4: Construction Noise Levels (dBA, Leq(h))..... 25

## **1.0 Introduction**

### **1.1 Purpose of Analysis and Study Objectives**

This noise assessment was prepared to evaluate whether the potential noise impacts associated with the project and project's construction would cause a significant impact from the project site to adjacent land uses. The assessment was conducted and compared to the noise standards set forth by the Federal, State and Local agencies. Consistent with the California Environmental Quality Act (CEQA) and CEQA Guidelines, a significant impact related to noise would occur if a proposed project is determined to result in:

- Generation of a substantial temporary or permanent increase in ambient noise levels in the vicinity of the project in excess of standards established in the local General Plan or noise ordinance, or applicable agencies.
- Generation of excessive ground-borne vibration or ground-borne noise levels.

The following is provided in this report:

- A description of the study area and the proposed project
- Information regarding the fundamentals of noise
- A description of the local noise guidelines and standards
- An evaluation of the existing ambient noise environment
- An analysis of stationary noise impacts from the project site to adjacent land uses
- Construction noise and vibration evaluation

### **1.2 Project Purpose and Overview**

Three Valleys Municipal Water District (TVMWD) is a wholesale water agency that provides water to the cities of Claremont, Pomona, Walnut, and East San Gabriel valleys. TVMWD's mission is to provide a reliable water source to local suppliers through the imported water it receives from the Metropolitan Water District of Southern California (MWD) as well as from surface water emanating from the San Gabriel mountains, and recycled water from local water treatment plants.

TVMWD operates the Miramar Water Treatment Plant (WTP) located at 1021 East Miramar Avenue in the City of Claremont. There are also two groundwater production wells located at this site. TVMWD is currently constructing an additional well at the terminus of Grand Avenue, approximately ½ mile south of the project site adjacent to the 210 freeway. The proposed MiraGrand Well represents the fourth production well to be developed in the vicinity in support of TVMWD's mission. The addition of the Grand Avenue well and the proposed MiraGrand Well will increase the reliability of TVMWD to provide an uninterrupted source of potable groundwater to its customers. TVMWD's strategy is to diversify its water supply and storage capabilities by increasing extraction capabilities to improve reliability of its water supplies, particularly during emergencies.

### **1.3 Site Location and Study Area**

The project site is located at 675 E. Miramar Avenue in the City of Claremont, California, as shown in Exhibit A. The property is situated within a residential area and is completely surrounded by single-family residences.

### **1.4 Proposed Project Description**

The Project proposes to construct a groundwater well surrounded by a concrete masonry building and approximately 150' of pipeline across Grand Avenue.



Exhibit A  
Location Map

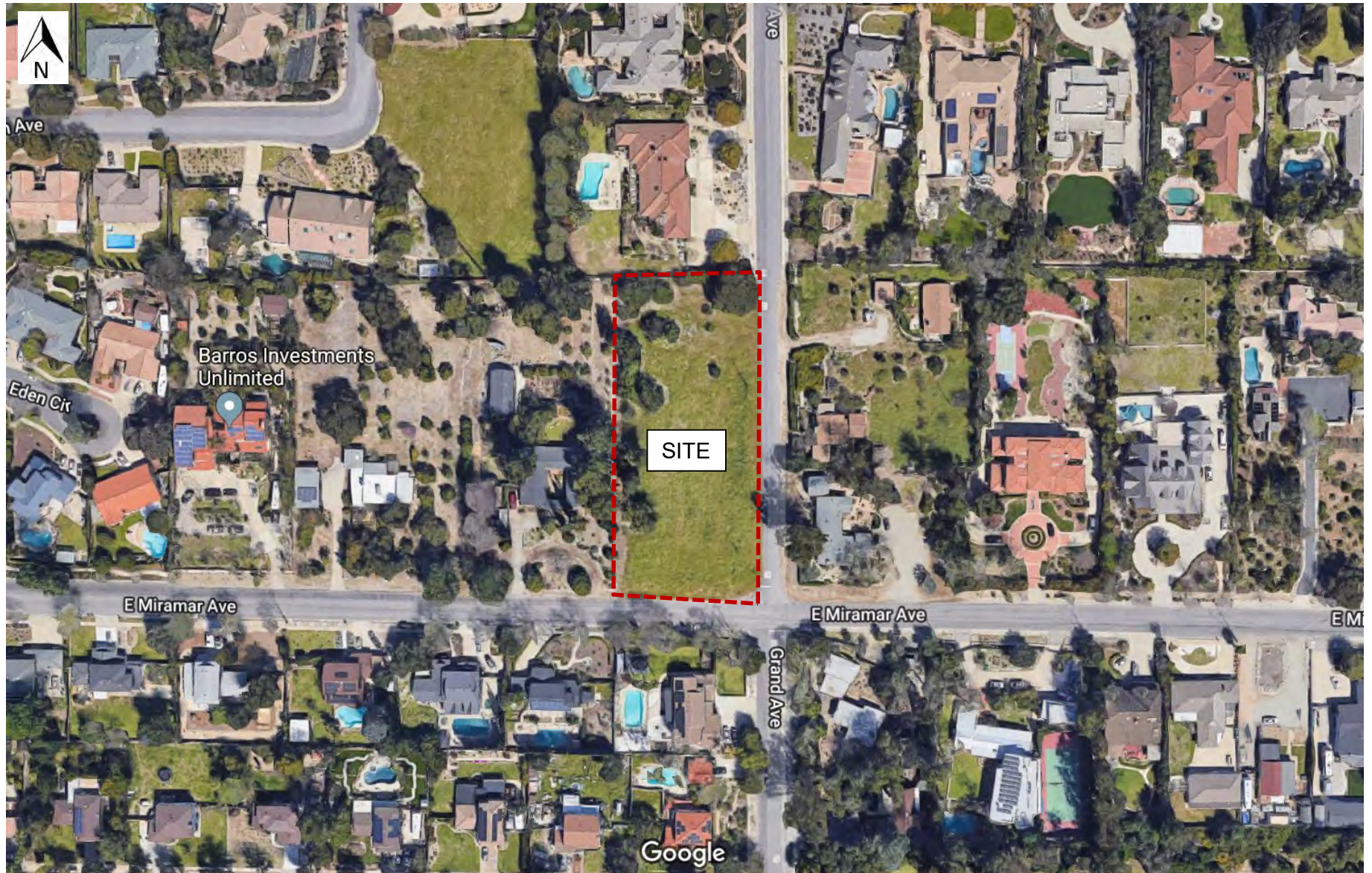

Exhibit B  
Site Plan



## 2.0 Fundamentals of Noise

This section of the report provides basic information about noise and presents some of the terms used within the report.

### 2.1 Sound, Noise and Acoustics

Sound is a disturbance created by a moving or vibrating source and is capable of being detected by the hearing organs. Sound may be thought of as mechanical energy of a moving object transmitted by pressure waves through a medium to a human ear. For traffic or stationary noise, the medium of concern is air. *Noise* is defined as sound that is loud, unpleasant, unexpected, or unwanted.

### 2.2 Frequency and Hertz

A continuous sound is described by its *frequency* (pitch) and its *amplitude* (loudness). Frequency relates to the number of pressure oscillations per second. Low-frequency sounds are low in pitch (bass sounding) and high-frequency sounds are high in pitch (squeak). These oscillations per second (cycles) are commonly referred to as Hertz (Hz). The human ear can hear from the bass pitch starting out at 20 Hz all the way to the high pitch of 20,000 Hz.

### 2.3 Sound Pressure Levels and Decibels

The *amplitude* of a sound determines its loudness. The loudness of sound increases or decreases as the amplitude increases or decreases. Sound pressure amplitude is measured in units of micro-Newton per square inch meter (N/m<sup>2</sup>), also called micro-Pascal ( $\mu$ Pa). One  $\mu$ Pa is approximately one hundred billionths (0.0000000001) of normal atmospheric pressure. Sound pressure level (SPL or  $L_p$ ) is used to describe in logarithmic units the ratio of actual sound pressures to a reference pressure squared. These units are called decibels abbreviated dB. Exhibit C illustrates references sound levels for different noise sources.

### 2.4 Addition of Decibels

Because decibels are on a logarithmic scale, sound pressure levels cannot be added or subtracted by simple plus or minus addition. When two sounds or equal SPL are combined, they will produce an SPL 3 dB greater than the original single SPL. In other words, sound energy must be doubled to produce a 3 dB increase. If two sounds differ by approximately 10 dB, the higher sound level is the predominant sound.

Exhibit C: Typical A-Weighted Noise Levels

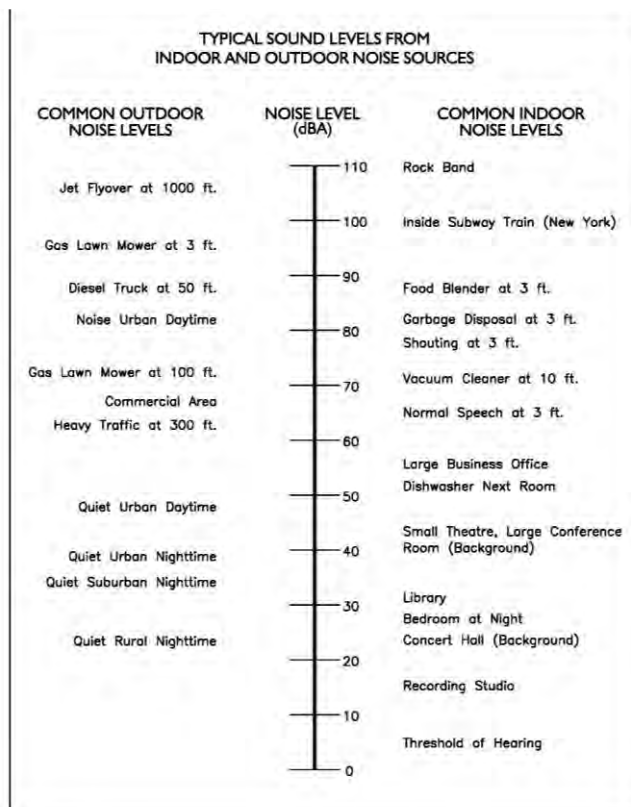

## 2.5 Human Response to Changes in Noise Levels

In general, the healthy human ear is most sensitive to sounds between 1,000 Hz and 5,000 Hz, (A-weighted scale) and it perceives a sound within that range as being more intense than a sound with a higher or lower frequency with the same magnitude. For purposes of this report as well as with most environmental documents, the A-scale weighting is typically reported in terms of A-weighted decibel (dBA). Typically, the human ear can barely perceive a change in noise level of 3 dB. A change in 5 dB is readily perceptible, and a change in 10 dB is perceived as being twice or half as loud. As previously discussed, a doubling of sound energy results in a 3 dB increase in sound, which means that a doubling of sound energy (e.g. doubling the volume of traffic on a highway) would result in a barely perceptible change in sound level.

## 2.6 Noise Descriptors

Noise in our daily environment fluctuates over time. Some noise levels occur in regular patterns, others are random. Some noise levels are constant while others are sporadic. Noise descriptors were created to describe the different time-varying noise levels.

**A-Weighted Sound Level:** The sound pressure level in decibels as measured on a sound level meter using the A-weighted filter network. The A-weighting filter de-emphasizes the very low and very high-frequency components of the sound in a manner similar to the response of the human ear. A numerical method of rating human judgment of loudness.

**Ambient or Background Noise Level:** The composite of noise from all sources, near and far. In this context, the ambient noise level constitutes the normal or existing level of environmental noise at a given location.

**Community Noise Equivalent Level (CNEL):** The average equivalent A-weighted sound level during a 24-hour day, obtained after addition of five (5) decibels to sound levels in the evening from 7:00 to 10:00 PM and after addition of ten (10) decibels to sound levels in the night before 7:00 AM and after 10:00 PM.

**dB(A):** A-weighted sound level (see definition below).

**Decibel (dB):** A unit for measuring the amplitude of a sound, equal to 20 times the logarithm to the base 10 of the ratio of the pressure of the sound measured to the reference pressure, which is 20 micro-pascals.

**Equivalent Sound Level (LEQ):** The sound level corresponding to a steady noise level over a given sample period with the same amount of acoustic energy as the actual time-varying noise level. The energy average noise level during the sample period.

**Field Sound Transmission Class (FSTC):** The field sound transmission class (FSTC) rating is used for in situ walls and floor/ceiling sound isolation performance assessment. The standard requires the measurement of sound transmission loss and includes the required procedure to show that the FSTC rating, as it has been determined by the test procedure, was not influenced by flanking of sound around the partition intended

to be tested. Sound transmission class and FSTC ratings are intended by standard to be equivalent; however, practical experience indicates that FSTC ratings tend to be up to five ratings points less than laboratory-measured STC ratings.

**Habitable Room:** Any room meeting the requirements of the Uniform Building Code or other applicable regulations which are intended to be used for sleeping, living, cooking or dining purposes, excluding such enclosed spaces as closets, pantries, bath or toilet rooms, service rooms, connecting corridors, laundries, unfinished attics, foyers, storage spaces, cellars, utility rooms and similar spaces.

**L(n):** The A-weighted sound level exceeded during a certain percentage of the sample time. For example, L10 in the sound level exceeded 10 percent of the sample time. Similarly L50, L90, and L99, etc.

**Noise:** Any unwanted sound or sound which is undesirable because it interferes with speech and hearing, or is intense enough to damage hearing, or is otherwise annoying. The State Noise Control Act defines noise as "...excessive undesirable sound...".

**Outdoor Living Area:** Outdoor spaces that are associated with residential land uses typically used for passive recreational activities or other noise-sensitive uses. Such spaces include patio areas, barbecue areas, jacuzzi areas, etc. associated with residential uses; outdoor patient recovery or resting areas associated with hospitals, convalescent hospitals, or rest homes; outdoor areas associated with places of worship which have a significant role in services or other noise-sensitive activities; and outdoor school facilities routinely used for educational purposes which may be adversely impacted by noise. Outdoor areas usually not included in this definition are: front yard areas, driveways, greenbelts, maintenance areas and storage areas associated with residential land uses; exterior areas at hospitals that are not used for patient activities; outdoor areas associated with places of worship and principally used for short-term social gatherings; and, outdoor areas associated with school facilities that are not typically associated with educational uses prone to adverse noise impacts (for example, school play yard areas).

**Percent Noise Levels:** See L(n).

**Sound Level (Noise Level):** The weighted sound pressure level obtained by use of a sound level meter having a standard frequency-filter for attenuating part of the sound spectrum.

**Sound Level Meter:** An instrument, including a microphone, an amplifier, an output meter, and frequency weighting networks for the measurement and determination of noise and sound levels.

**Single Event Noise Exposure Level (SENEL):** The dB(A) level which, if it lasted for one second, would the same A-weighted sound energy as the actual event.

**Sound Transmission Class (STC):** To quantify STC, a Transmission Loss (TL) measurement is performed in a laboratory over a range of 16 third-octave bands between 125 – 4,000 Hertz (Hz). The average human voice creates sound within the 125 – 4,000 Hz 1/3<sup>rd</sup> octave bands.

STC is a single-number rating given to a particular material or assembly. The STC rating measures the ability of a material or an assembly to resist airborne sound transfer over the specified frequencies (see ASTM International Classification E413 and E90). In general, a higher STC rating corresponds with a greater reduction of noise transmitting through a partition.

STC is highly dependent on the construction of the partition. The STC of a partition can be increased by adding mass, increasing or adding air space, adding absorptive materials within the assembly. The STC rating does not assess low-frequency sound transfer (e.g. sounds less than 125 Hz). Special consideration must be given to spaces where the noise transfer concern has lower frequencies than speech, such as mechanical equipment and or/or music. The STC rating is a lab test that does not take into consideration weak points, penetrations, or flanking paths.

Even with a high STC rating, any penetration, air-gap, or “flanking path can seriously degrade the isolation quality of a wall. Flanking paths are the means for sound to transfer from one space to another other than through the wall. Sound can flank over, under, or around a wall. Sound can also travel through common ductwork, plumbing or corridors. Noise will travel between spaces at the weakest points. Typically, there is no reason to spend money or effort to improve the walls until all weak points are controlled first.

## **2.7 Traffic Noise Prediction**

Noise levels associated with traffic depends on a variety of factors: (1) volume of traffic, (2) speed of traffic, (3) auto, medium truck (2–3 axle) and heavy truck percentage (4 axle and greater), and sound propagation. The greater the volume of traffic, higher speeds, and truck percentages equate to a louder volume in noise. A doubling of the Average Daily Traffic (ADT) along a roadway will increase noise levels by approximately 3 dB; reasons for this are discussed in the sections above.

## **2.8 Sound Propagation**

As sound propagates from a source it spreads geometrically. Sound from a small, localized source (i.e., a point source) radiates uniformly outward as it travels away from the source in a spherical pattern. The sound level attenuates at a rate of 6 dB per doubling of distance. The movement of vehicles down a roadway makes the source of the sound appear to propagate from a line (i.e., line source) rather than a point source. This line source results in the noise propagating from a roadway in a cylindrical spreading versus a spherical spreading that results from a point source. The sound level attenuates for a line source at a rate of 3 dB per doubling of distance.

As noise propagates from the source, it is affected by the ground and atmosphere. Noise models use hard site (reflective surfaces) and soft site (absorptive surfaces) to help calculate predicted noise levels. Hard site conditions assume no excessive ground absorption between the noise source and the receiver. Soft site conditions such as grass, soft dirt or landscaping attenuate noise at a rate of 1.5 dB per doubling of distance. When added to the geometric spreading, the excess ground attenuation results in an overall noise attenuation of 4.5 dB per doubling of distance for a line source and 7.5 dB per doubling of distance for a point source.

Research has demonstrated that atmospheric conditions can have a significant effect on noise levels when noise receivers are located 200 feet from a noise source. Wind, temperature, air humidity, and turbulence can further impact how far sound can travel.

## **3.0 Ground-Borne Vibration Fundamentals**

### **3.1 Vibration Descriptors**

Ground-borne vibrations consist of rapidly fluctuating motions within the ground that have an average motion of zero. The effects of ground-borne vibrations typically only cause a nuisance to people, but at extreme vibration levels, damage to buildings may occur. Although ground-borne vibration can be felt outdoors, it is typically only an annoyance to people indoors where the associated effects of the shaking of a building can be notable. Ground-borne noise is an effect of ground-borne vibration and only exists indoors since it is produced from noise radiated from the motion of the walls and floors of a room and may also consist of the rattling of windows or dishes on shelves.

Several different methods are used to quantify vibration amplitude.

**PPV** – Known as the peak particle velocity (PPV) which is the maximum instantaneous peak in vibration velocity, typically given in inches per second.

**RMS** – Known as root mean squared (RMS) can be used to denote vibration amplitude

**VdB** – A commonly used abbreviation to describe the vibration level (VdB) for a vibration source.

### **3.2 Vibration Perception**

Typically, developed areas are continuously affected by vibration velocities of 50 VdB or lower. These continuous vibrations are not noticeable to humans whose threshold of perception is around 65 VdB. Outdoor sources that may produce perceptible vibrations are usually caused by construction equipment, steel-wheeled trains, and traffic on rough roads, while smooth roads rarely produce perceptible ground-borne noise or vibration. To counter the effects of ground-borne vibration, the Federal Transit Administration (FTA) has published guidance relative to vibration impacts. According to the FTA, fragile buildings can be exposed to ground-borne vibration levels of 0.3 inches per second without experiencing structural damage.

### **3.3 Vibration Perception**

There are three main types of vibration propagation: surface, compression, and shear waves. Surface waves, or Rayleigh waves, travel along the ground's surface. These waves carry most of their energy along an expanding circular wave front, similar to ripples produced by throwing a rock into a pool of water. P-waves, or compression waves, are body waves that carry their energy along an expanding spherical wavefront. The particle motion in these waves is longitudinal (i.e., in a "push-pull" fashion). P-waves are analogous to airborne sound waves. S-waves, or shear waves, are also body waves that carry energy along an expanding spherical wavefront. However, unlike P-waves, the particle motion is transverse, or side-to-side and perpendicular to the direction of propagation.

As vibration waves propagate from a source, the vibration energy decreases in a logarithmic nature and the vibration levels typically decrease by 6 VdB per doubling of the distance from the vibration source.



As stated above, this drop-off rate can vary greatly depending on the soil but has been shown to be effective enough for screening purposes, in order to identify potential vibration impacts that may need to be studied through actual field tests.

## 4.0 Regulatory Setting

The proposed project is located in the City of Claremont and noise regulations are addressed through the efforts of various federal, state and local government agencies. The agencies responsible for regulating noise are discussed below.

### 4.1 Federal Regulations

The adverse impact of noise was officially recognized by the federal government in the Noise Control Act of 1972, which serves three purposes:

- Publicize noise emission standards for interstate commerce
- Assist state and local abatement efforts
- Promote noise education and research

The Federal Office of Noise Abatement and Control (ONAC) originally was tasked with implementing the Noise Control Act. However, it was eventually eliminated leaving other federal agencies and committees to develop noise policies and programs. Some examples of these agencies are as follows: The Department of Transportation (DOT) assumed a significant role in noise control through its various agencies. The Federal Aviation Agency (FAA) is responsible for regulating noise from aircraft and airports. The Federal Highway Administration (FHWA) is responsible for regulating noise from the interstate highway system. The Occupational Safety and Health Administration (OSHA) is responsible for the prohibition of excessive noise exposure to workers.

The federal government advocates that local jurisdictions use their land use regulatory authority to arrange new development in such a way that “noise sensitive” uses are either prohibited from being constructed adjacent to a highway or, alternatively that the developments are planned and constructed in such a manner that potential noise impacts are minimized.

Since the federal government has preempted the setting of standards for noise levels that can be emitted by the transportation source, the City is restricted to regulating the noise generated by the transportation system through nuisance abatement ordinances and land use planning.

### 4.2 State Regulations

Established in 1973, the California Department of Health Services Office of Noise Control (ONC) was instrumental in developing regulatory tools to control and abate noise for use by local agencies. One significant model is the “Land Use Compatibility for Community Noise Environments Matrix.” The matrix allows the local jurisdiction to clearly delineate compatibility of sensitive uses with various incremental levels of noise.

The State of California has established noise insulation standards as outlined in Title 24 and the Uniform Building Code (UBC) which in some cases requires acoustical analyses to outline exterior noise levels and to ensure interior noise levels do not exceed the interior threshold. The State mandates that the legislative body of each county and city adopt a noise element as part of its comprehensive general plan.

The local noise element must recognize the land use compatibility guidelines published by the State Department of Health Services. The City of Claremont has published their version of these guidelines as illustrated in Exhibit D.

**Exhibit D: Land Use Compatibility Guidelines**

Property Receiving Noise		Maximum Noise Level (Ldn or CNEL, dBA)	
Type of Use	Zoning Designations	Interior	Exterior <sup>3</sup>
Residential	Hillside	45	65
	Rural		
	Very Low		
	Low		
Residential	Low Medium	45	65 / 70 <sup>1</sup>
	Medium		
	High		
Commercial and Office	Professional Commercial Neighborhood	-	70
	Limited		
	Major		
	Highway		
	Freeway		
Commercial and Office	Professional Office	50	70
	Business Park	55	75
Public/Institutional	Schools	50	65
	All others	50	70
Open Space	Active Open Space	-	70
	Passive Open Space	-	70 / 65 <sup>2</sup>

<sup>1</sup> Maximum exterior noise levels up to 70 dB CNEL are allowed for Multiple-Family Housing.

<sup>2</sup> Where quiet is a basis required for the land use.

<sup>3</sup> Regarding aircraft-related noise, the maximum acceptable exposure for new residential development is 60 dB CNEL.

### 4.3 City of Claremont Noise Regulations

The City of Claremont outlines their noise regulations and standards within the Public Safety and Noise Element from the General Plan and the Noise Ordinance from the Municipal Code.

#### City of Claremont General Plan

Applicable policies and standards governing environmental noise in the City are set forth in the General Noise Element. Section 16.154.020 of the Claremont Municipal Code outlines the base noise standards as 60 dBA from 7AM to 10PM and 55 dBA from 10PM to 7AM for residential use. Therefore, the project must demonstrate compliance to the City's noise standards.

In addition to the noise standards, the City has outlined goals, policies and implementation measures to reduce potential noise impacts and are presented below:

**Goals, Policies, and Implementation Measures**

Policies and goals from the Safety and Noise Chapter that would mitigate potential impacts on noise include the following. All General Plan policies are followed by a set of numbers in parentheses. These numbers reference measures that will be undertaken by the City to implement the policy.

**Non-Transportation Noise Sources**

**Goal 6-12** Minimize the impact of excessive noise levels throughout the community and adopt appropriate noise level requirements for all land uses.

- 6-12.1 Use noise contour maps and noise/land use compatibility criteria in planning and development decisions.
- 6-12.2 Develop standards and encourage private property owners to locate, screen, and/or buffer equipment in order to reduce noise impacts on surrounding areas.
- 6-12.3 Minimize noise from property maintenance equipment, construction activities and other non transportation noise sources by enforcing designated construction and maintenance hours.
- 6-12.4 Require mitigation of any potential noise impacts before allowing mining of aggregate resources.

**City of Claremont – Noise Ordinance**

D. Exterior Noise Standards

- 1. The Base Noise Level is the ambient noise level or the Ambient Base Noise Level, whichever is higher. The Ambient Base Noise Levels are as follows:

**Table 1: Allowable Exterior Noise Level<sup>1</sup>**

Noise Zone	Type of Land Use	Allowed Equivalent Noise Level, Leq	
		7:00 am to 10:00 pm	10:00 pm to 7:00 am
I	Residential - Exterior Noise	60 dBA	55 dBA
II	Commercial - Exterior Noise	65 dBA	60 dBA
III	Industrial - Exterior	70 dBA	70 dBA
Notes: 1. If the ambient noise exceeds the resulting standard, the ambient noise level shall be the standard.			

Each of the noise limits above shall be reduced 5 dBA for noise consisting of impulse or simple tone noise.

- 2. It shall be unlawful for any person at any location within the incorporated area of the City to create any noise or allow the creation of any noise on the property owned, leased, occupied, or otherwise

controlled by such person, which causes the noise level when measured on the property line of any other property to exceed the basic noise level as adjusted below:

Basic Noise Level for a cumulative period of more than 15 minutes in any one hour; or

Basic Noise Level plus 5 dBA for a cumulative period of more than 10 minutes in any one hour; or

Basic Noise Level plus 14 dBA for a cumulative period of more than 5 minutes in any one hour; or

Basic Noise Level plus 15 dBA at any time.

3. If the measurement location is a boundary between two different noise zones, the lower noise level standard shall apply.

4. If the intruding noise source is continuous and cannot reasonably be discontinued or stopped for a time period whereby the ambient noise level can be determined, the measured noise level obtained while the noise is in operation shall be compared directly to the allowable noise level standards as specified respective to the measurement location's designated land use and for the time of day the noise level is measured. The reasonableness of temporarily discontinuing the noise generation by an intruding noise source shall be determined by the Director or his/her duly authorized deputy for the purpose of establishing the existing ambient noise level at the measurement location.

### **Construction Noise Regulations**

#### F. Exemptions

The following activities shall be exempted from the provisions of this chapter:

4. Noise sources associated with or vibration created by construction, repair, remodeling or grading of any real property, or during authorized seismic surveys, provided:

a. Activities take place between the hours of 7:00 AM and 8:00 PM weekdays and Saturdays, excluding national holidays; and

b. Noise levels, as measured on residential properties, do not exceed 65 dBA for a cumulative period of more than 15 minutes in any one hour, 70 dBA for a cumulative period of more than 10 minutes in any one hour, 79 dBA for a cumulative period of more than 5 minutes in any one hour or 80 dBA at any time; and

c. Any vibration created does not endanger the public health, welfare, and safety. Only that construction, repair, remodeling and grading activity that does not exceed the noise levels set by Section 16.154.020.D may occur on Sundays and national holidays.

## **Vibration**

### J. Vibration

Notwithstanding other sections of this chapter, it shall be unlawful for any person to create, maintain or cause any ground vibration which is perceptible without instruments at any point on any affected property adjoining the property on which the vibration source is located. For the purpose of this chapter, the perception threshold shall be presumed to be more than 0.05 inches per second RMS vertical velocity.

### **Threshold Applied to the Project**

#### ***Operational***

The project's operation is continuous day and night and therefore must not exceed the basic noise level as outlined in Table 1 (Section 16.154.020)(D)). The residential exterior standard is 60 dBA, Leq (15-min) from 7AM to 10PM, and 55 dBA, Leq (15-min) from 10PM to 7AM as measured on any residential property.

In addition, the noise level must not exceed the following standards at the property line:

- Basic Noise Level plus 5 dBA for a cumulative period of more than 10 minutes in any one hour; (>65 dBA for 10 minutes, 7AM – 10PM and >60 dBA for 10 min, 10PM to 7AM)
- Basic Noise Level plus 14 dBA for a cumulative period of more than 5 minutes in any one hour; (>74 dBA for 5 minutes, 7AM – 10PM and >69 dBA for 5 min, 10PM to 7AM)
- Basic Noise Level plus 15 dBA at any time (>75 dBA for anytime, 7AM – 10PM and >70 dBA, 10PM to 7AM).

Project operations were compared to the strictest daytime and nighttime standard of 60 dBA and 55 dBA, respectively. In addition to the City

Any construction activity which occurs between the hours of 8PM and 7AM or on Sundays or holidays, such as the continuous 24-hour well drilling, must follow these residential standards outlined above.

#### ***Construction***

Construction activity between 7AM and 8PM weekdays and Saturdays must not exceed 65 dBA for more than 15 minutes in an hour, 70 dBA for more than 10 minutes in an hour, 79 dBA for more than 5 minutes in an hour, and 80 dBA at any time.

## **5.0 Study Method and Procedure**

The following section describes the noise modeling procedures and assumptions used for this assessment.

### **5.1 Noise Measurement Procedure and Criteria**

Noise measurements are taken to determine the existing noise levels. A noise receiver or receptor is any location in the noise analysis in which noise might produce an impact. The following criteria are used to select measurement locations and receptors:

- Locations expected to receive the highest noise impacts, such as the first row of houses
- Locations that are acoustically representative and equivalent of the area of concern
- Human land usage
- Sites clear of major obstruction and contamination

MD conducted the sound level measurements in accordance with the City noise ordinance and similar parameters to the CalTrans technical noise specifications. All measurement equipment meets American National Standards Institute (ANSI) specifications for sound level meters (S1.4-1983 identified in Chapter 19.68.020.AA). The following gives a brief description of the Caltrans Technical Noise Supplement procedures for sound level measurements:

- Microphones for sound level meters were placed 5-feet above the ground for all measurements
- Sound level meters were calibrated (Larson Davis CAL 200) before and after each measurement
- Following the calibration of equipment, a windscreen was placed over the microphone
- Frequency weighting was set on "A" and slow response
- Results of the long-term noise measurements were recorded on field data sheets
- During any short-term noise measurements, any noise contaminations such as barking dogs, local traffic, lawn mowers, or aircraft fly-overs were noted
- Temperature and sky conditions were observed and documented

### **5.2 Noise Measurement Locations**

Noise measurement locations were selected based on the nearest adjacent land use to project site. A total of (1) 24-hour noise measurement was conducted at the project site. The field data is utilized to characterize the existing ambient conditions within the project vicinity is illustrated in Exhibit E. Appendix A includes photos, field sheet, and measured noise data.

### **5.3 Operational Stationary Noise Modeling**

The operational noise was evaluated based on the inverse square law, proposed well pump enclosure design and reference equipment noise level data) to calculate noise level projections. The project proposes to use a 125-horsepower well motor. MD has previously performed field measurements on 400 horsepower well motors (see Appendix B) and therefore utilizes the data for a 400 horsepower well motor

as a worst-case scenario. Noise from a 125-horsepower well motor is anticipated to be quieter and therefore the noise data and projections for a 400-horsepower motor would be considered conservative.

The overall noise level is 90 dBA, Leq at 3 feet from the 400-hp motor. The noise is projected to the nearest sensitive receptor with noise attenuation through a masonry building, lined with acoustical panels. MD calculated the noise attenuation based on the well enclosure building envelop design (See Section 7.1.1).

#### **5.4 FHWA Roadway Construction Noise Model**

The construction noise analysis utilizes the Federal Highway Administration (FHWA) Roadway Construction Noise Model (RNCM), together with several key construction parameters. Key inputs include distance to the sensitive receiver, equipment usage, % usage factor, and baseline parameters for the project site.

The project was analyzed based on the different construction phases. Construction noise is expected to be loudest during the cutting and drilling phases of construction. The construction noise calculation output worksheet is located in Appendix C. The following assumptions relevant to short-term construction noise impacts were used:

- The duration of well drilling construction activities is estimated to be three to four months with preparation of each phase in-between the actual construction. Several of the phases will overlap.
- Cutting of pavement/concrete will last approximately 3 to 5 days.
- 24-hour drilling will last approximately 10 to 14 days.
- Laying of pipe (100 to 150 feet) along Miramar Avenue will last approximately 2 to 3 days.
- Repaving will last approximately 3 days.
- Enclosure construction will last approximately 4 weeks.



Measurement Locations

1 = Long-term  
Monitoring Location

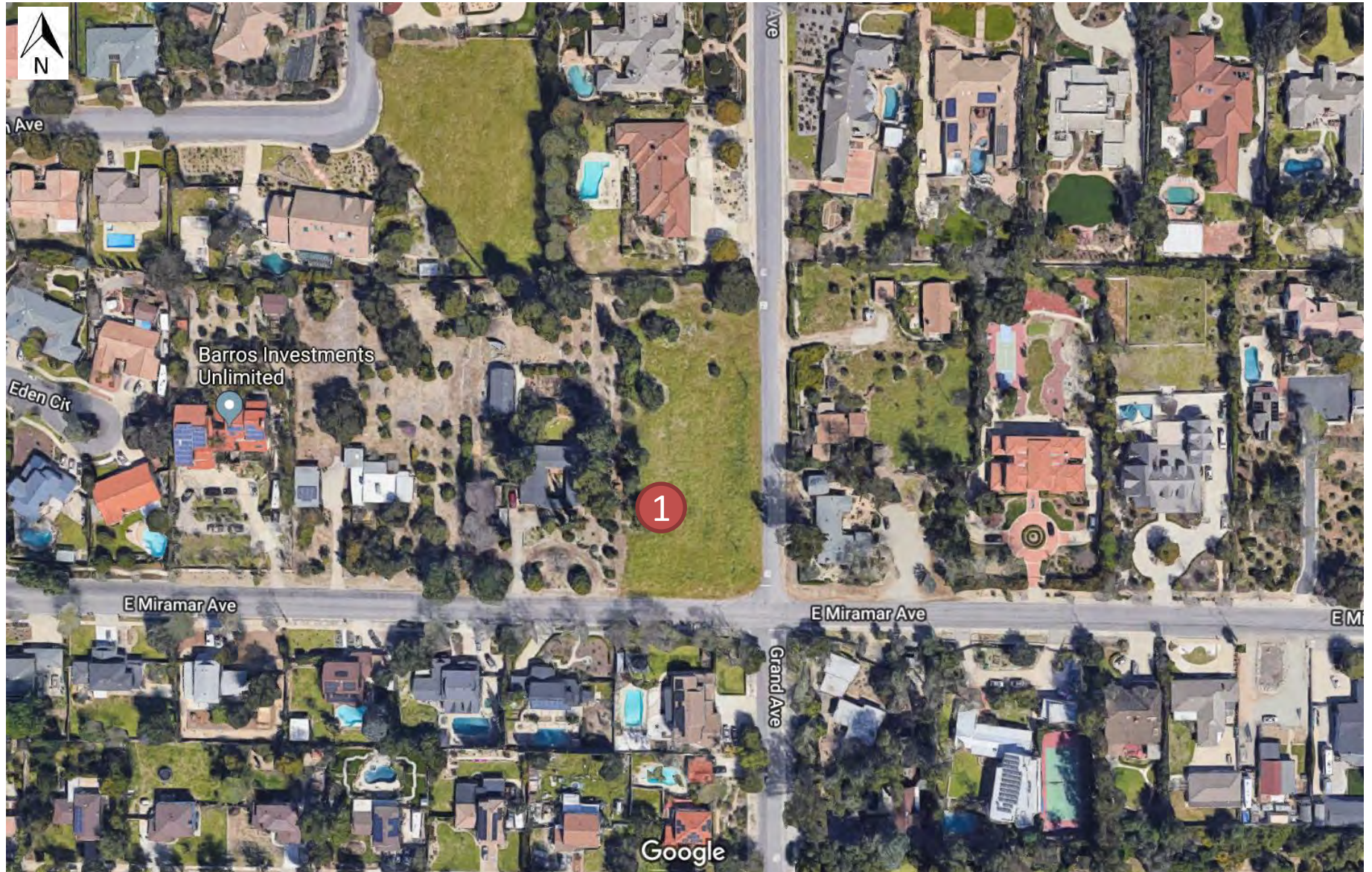

## 6.0 Existing Noise Environment

A twenty-four (24) hour ambient noise measurement was conducted at the project site approximately 99 feet from the center of Miramar Ave and 133 feet from the centerline of Grand Ave. The measurement measured the 1-hour Leq, Lmin, Lmax and other statistical data (e.g. L2, L8). The noise measurement was taken to determine the existing baseline noise conditions.

### 6.1 Noise Measurement Results

The results of the field measurements are provided in Table 2.

**Table 2: Long-Term Noise Measurement Data<sup>1</sup>**

Date	Time	dB(A)							
		LEQ	LMAX	LMIN	L2	L8	L25	L50	L90
7/11/2019	6AM-7AM	55.8	83.2	44.0	63.1	50.9	49.3	48.6	47.7
7/11/2019	7AM-8AM	57.4	72.1	40.3	68.1	59.8	57.1	56.7	53.1
7/11/2019	8AM-9AM	56.6	64.3	55.9	57.3	56.9	56.7	56.7	56.5
7/11/2019	9AM-10AM	52.2	71.4	37.0	60.1	56.5	56.1	48.8	44.2
7/11/2019	10AM-11AM	46.9	65.7	35.4	57.6	50.0	46.8	44.7	40.6
7/11/2019	11AM-12PM	49.3	68.4	35.5	60.7	52.1	48.5	45.8	40.8
7/11/2019	12PM-1PM	53.1	76.0	36.7	64.5	53.6	49.0	46.3	41.7
7/11/2019	1PM-2PM	50.2	70.8	36.6	59.1	52.3	49.6	47.8	44.3
7/11/2019	2PM-3PM	48.2	71.0	36.8	57.2	48.1	45.6	44.2	41.8
7/11/2019	3PM-4PM	62.6	77.5	38.8	70.9	68.4	66.9	63.0	44.5
7/11/2019	4PM-5PM	47.2	65.4	38.5	58.7	49.7	46.3	44.7	42.5
7/11/2019	5PM-6PM	46.8	70.2	39.1	54.8	48.7	46.6	45.4	43.2
7/11/2019	6PM-7PM	45.1	59.7	39.0	52.8	48.2	46.1	44.8	42.8
7/11/2019	7PM-8PM	43.7	56.5	38.3	51.0	46.4	44.4	43.5	41.9
7/11/2019	8PM-9PM	44.6	57.1	39.4	51.4	47.1	45.3	44.5	43.1
7/11/2019	9PM-10PM	45.5	62.4	37.0	53.2	46.6	45.5	44.9	43.5
7/11/2019	10PM-11PM	57.2	85.0	37.6	60.2	44.8	43.4	42.9	41.9
7/11/2019	11PM-12AM	43.0	55.4	39.2	47.0	45.1	44.0	43.3	42.3
7/12/2019	12AM-1AM	48.2	58.9	41.1	53.4	51.1	49.7	48.8	47.3
7/12/2019	1AM-2AM	46.6	54.1	41.3	51.2	49.0	48.1	47.5	45.9
7/12/2019	2AM-3AM	46.9	54.0	42.1	51.9	49.4	47.7	46.9	45.6
7/12/2019	3AM-4AM	49.1	55.9	44.1	50.0	48.6	48.0	47.6	46.6
7/12/2019	4AM-5AM	50.7	69.9	45.6	52.2	51.1	50.4	49.8	48.7
7/12/2019	5AM-6AM	61.8	81.8	47.1	54.6	52.7	51.7	51.1	50.0
DNL		58.5							
Notes:									
<sup>1</sup> Long-term noise monitoring location 1 (LT1) is illustrated in Exhibit E.									

Noise data indicates that ambient noise data at the southwest portion of the project site ranges between 43.0 to 61.8 dBA Leq(h). The existing daytime 60 dBA Leq(h) and nighttime 55 dBA Leq(h) conditions are exceeded at various times as indicated in the highlighted yellow areas of Table 2. The exceedances are as a result of existing traffic conditions along the subject roadways.

The measured DNL is 58.5 and is within the normally acceptable range when comparing the level to the City's noise compatibility matrix and municipal code.

## **7.0 Future Noise Environment Impacts and Mitigation**

This assessment analyzes future noise impacts as a result of the project and compares the results to the City's Noise Standards. Potential stationary noise impacts associated with the well pump were projected to the adjacent sensitive land uses.

### **7.1 Future Exterior Noise**

The following outlines the exterior noise levels associated with the proposed project.

#### **7.1.1 Stationary Source Noise**

The project is surrounded by single family residential uses that may be affected by project operational noise. The main source of operational noise from the well will be the 100-horsepower pump motor which will be enclosed by a masonry building as shown in Exhibit F. The room which holds the well and motor will be lined with acoustic panels to further reduce impact to the surrounding residences.

Based on the referenced data, the motor noise is approximately 90 dBA, Leq at 3 feet from the motor. When projecting the noise level to the nearest sensitive receptor (100 feet from the motor), the noise would measure 59.5 dBA, Leq.

As previously mentioned, the project proposes to enclose the motor in a masonry building with a room lined with acoustic panels which will provide at least 30 dB reduction. The noise at the closest sensitive receptor would be approximately 30 dBA, Leq, which is below the City's noise ordinance and will not increase the ambient noise level. When comparing the projected operational noise level (30 dBA, Leq) to the quietest measured baseline hourly noise level of 43.0 dBA (11PM – 12PM), the projected level is approximately 13 dB lower than the quietest measured noise level. The project's operations will meet the City's stationary noise limit and will not have a significant impact.

Furthermore, the operational noise will not exceed the City's 65 DNL/CNEL land use compatibility noise matrix for residential uses.

Exhibit F  
Proposed Well Pump Enclosure

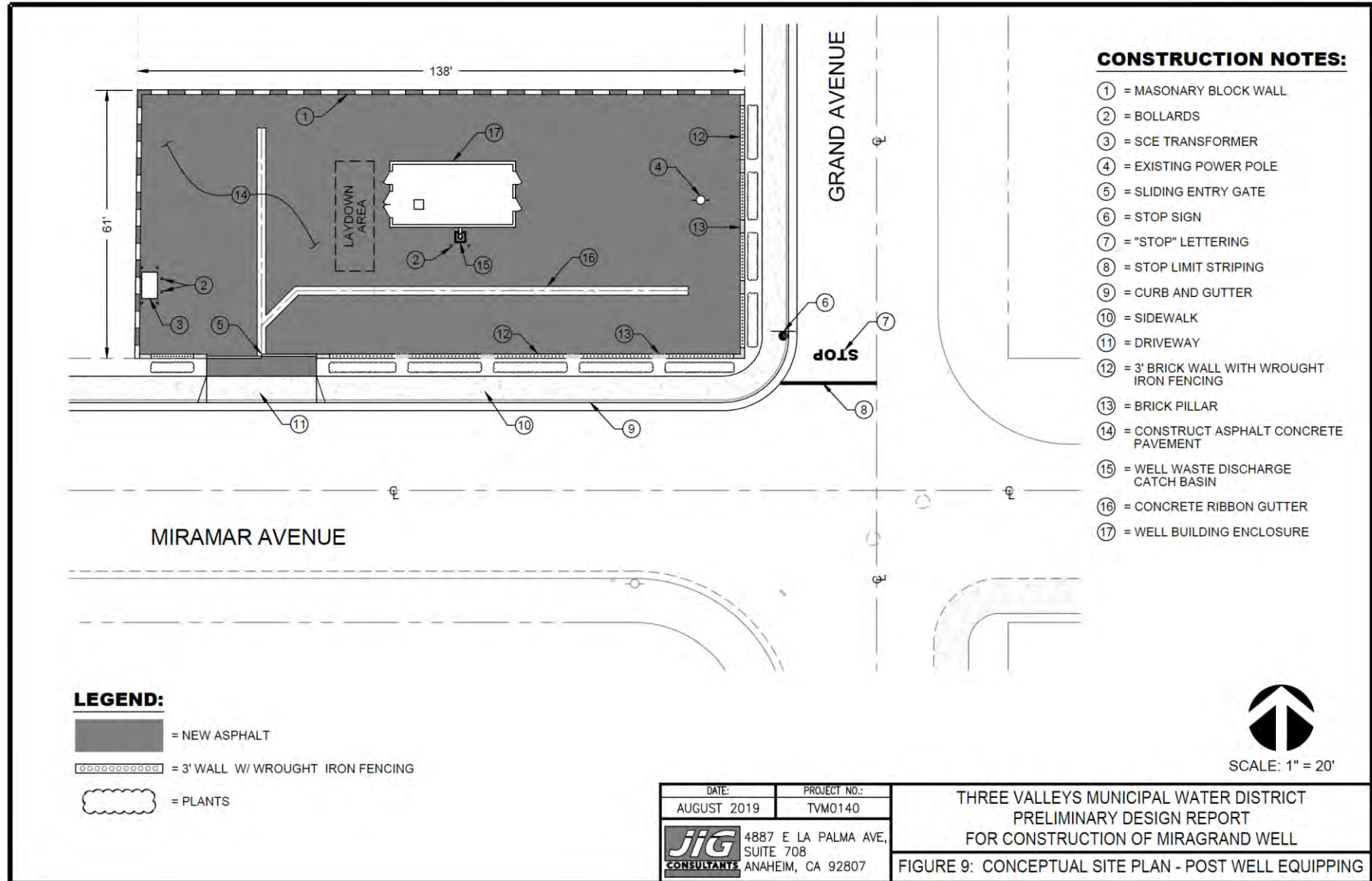

## 8.0 Construction Noise Impact

The degree of construction noise may vary for different areas of the project site and also vary depending on the construction activities. Noise levels associated with the construction will vary with the different phases of construction.

### 8.1 Construction Noise

The Federal Highway Administration has compiled data regarding the noise generated characteristics of typical construction activities. The data is presented in Table 3.

**Table 3: CA/T Equipment Noise Emissions and Acoustical Usage Factor Database**

Equipment Description	Impact Device?	Acoustical use Factor (%)	Spec. 721.560 Lmax @ 50ft (dBA, slow)	Actual Measured Lmax @ 50ft (dBA, slow)	No. of Actual Data Samples (Count)
All Other Equipment > 5 HP	No	50	85	-N/A-	0
Auger Drill Rig	No	20	85	84	36
Backhoe	No	40	80	78	372
Bar Bender	No	20	80	-N/A-	0
Blasting	Yes	-N/A-	94	-N/A-	0
Boring Jack Power Unit	No	50	80	83	1
Chain Saw	No	20	85	84	46
Clam Shovel (dropping)	Yes	20	93	87	4
Compactor (ground)	No	20	80	83	57
Compressor (air)	No	40	80	78	18
Concrete Batch Plant	No	15	83	-N/A-	0
Concrete Mixer Truck	No	40	85	79	40
Concrete Pump Truck	No	20	82	81	30
Concrete Saw	No	20	90	90	55
Crane	No	16	85	81	405
Dozer	No	40	85	82	55
Drill Rig Truck	No	20	84	79	22
Drum Mixer	No	50	80	80	1
Dump Truck	No	40	84	76	31
Excavator	No	40	85	81	170
Flat Bed Truck	No	40	84	74	4
Front End Loader	No	40	80	79	96
Generator	No	50	82	81	19
Generator (<25KVA, VMS signs)	No	50	70	73	74
Gradall	No	40	85	83	70
Grader	No	40	85	-N/A-	0
Grapple (on backhoe)	No	40	85	87	1
Horizontal Boring Hydr. Jack	No	25	80	82	6
Hydra Break Ram	Yes	10	90	-N/A-	0
Impact Pile Driver	Yes	20	95	101	11
Jackhammer	Yes	20	85	89	133
Man Lift	No	20	85	75	23
Mounted Impact hammer (hoe ram)	Yes	20	90	90	212
Pavement Scarafier	No	20	85	90	2

Paver	No	50	85	77	9
Pickup Truck	No	40	55	75	1
Pneumatic Tools	No	50	85	85	90
Pumps	No	50	77	81	17
Refrigerator Unit	No	100	82	73	3
Rivit Buster/chipping gun	Yes	20	85	79	19
Rock Drill	No	20	85	81	3
Roller	No	20	85	80	16
Sand Blasting (Single Nozzle)	No	20	85	96	9
Scraper	No	40	85	84	12
Shears (on backhoe)	No	40	85	96	5
Slurry Plant	No	100	78	78	1
Slurry Trenching Machine	No	50	82	80	75
Soil Mix Drill Rig	No	50	80	-N/A-	0
Tractor	No	40	84	-N/A-	0
Vacuum Excavator (Vac-truck)	No	40	85	85	149
Vacuum Street Sweeper	No	10	80	82	19
Ventilation Fan	No	100	85	79	13
Vibrating Hopper	No	50	85	87	1
Vibratory Concrete Mixer	No	20	80	80	1
Vibratory Pile Driver	No	20	95	101	44
Warning Horn	No	5	85	83	12
Welder/Torch	No	40	73	74	5

Table 4 provides the construction noise level projections during the various phases of construction.

**Table 4: Construction Noise Levels (dBA, Leq(h))**

Location	Phase	Construction Noise Level <sup>1</sup>	Reduction with Mufflers	Reduction with Wall	Abated Noise Level	Ambient Level <sup>2</sup>	Final Projected Noise Level
Residences	Cutting	88.8	-15.0	N/A	73.8	46.8	73.8
	Laying	87.4	-15.0	N/A	72.4	46.8	72.4
	Paving	88.2	-15.0	N/A	73.2	46.8	73.2
	Drilling	59.0	N/A	-14.0	45.0	43.0	47.1
	Building	78.6	-15.0	-14.0	49.6	46.8	51.4
Notes: 1. Distance projected from center of proposed road/well to nearest home. 2. Lowest ambient level during operational hours.							

As shown in Table 4, the noise level during the various phases of construction will vary between 47.1 to 73.8 dBA. The noise level projections include the reduced noise as a result of mufflers and the 24-foot tall noise barrier surrounding the project construction site (see Exhibit G).

Noise from pavement/concrete cutting will be intermittent and short-term in nature such that while the cutting occurs the noise will reach 73.8 dBA at the nearest sensitive receptor, but when cutting does not occur the noise will fall back down to the ambient condition. Cutting of pavement will occur over a 3 to

5-day period with intermittent saw cutting. In addition, saw cutting will only occur between 7AM to 6PM. Therefore, the noise from cutting is temporary and considered a short-term impact.

Laying of pipe along Miramar Avenue will last approximately 2 to 3 days. Noise will reach up to 72.4 dBA. The noise from laying of pipe is short-term and temporary in nature. Laying of pipe will only occur between 7AM to 6PM.

The 24-hour drilling will last approximately 10 to 14 days. The projected noise level to the nearest sensitive receptor is 47.1 dBA which is below the City's 55 dBA nighttime noise requirement. Noise from drilling will be mitigated using 24-foot tall barriers and mufflers on drilling equipment engines. Therefore, the impact is less than significant with mitigation.

The repaving of the roadway will last approximately 3-days. The projected noise level to the nearest sensitive receptor is 73.2 dBA. Paving will only occur between 7AM to 6PM, and the noise will be intermittent during paving.

Noise during the construction of the enclosure is projected to be 51.4 dBA and is below the City's noise limit. Construction is anticipated to occur only during the hours of 7AM to 6PM, and therefore the impact is considered less than significant.

Construction is anticipated to occur during the permissible hours according the City's Municipal Code except for the 24-hour drilling which should not exceed the nighttime residential noise limit. Construction noise will have a temporary or periodic increase in the ambient noise level above the existing within the project vicinity. Furthermore, construction design noise reduction measures are provided to further reduce construction noise (Section 8.3).

## **8.2 Construction Vibration**

Construction activities can produce vibration that may be felt by adjacent land uses. The construction of the proposed project would not require the use of equipment such as pile drivers, which are known to generate substantial construction vibration levels. According to the FTA Noise and Vibration Impact Assessment manual, a loaded truck has a PPV of 0.076 in/sec (86 VdB) at 25 feet. At 40 feet from the truck the maximum PPV is 0.045 in/sec and is below any threshold of damage. Appendix D provides the vibration calculations. This is within the municipal code guidelines for perception of vibration. No additional mitigation measures are needed.

## **8.3 Construction Design Noise Reduction Measures**

Construction operations must follow the City's General Plan and the Noise Ordinance, which states that construction, repair or excavation work performed must occur within the permissible hours. To further ensure that construction activities do not disrupt the adjacent land uses, the following measures will be taken:

1. Construction will occur between the hours of 7AM and 6PM. Monday through Saturday except during holidays.



2. During construction, the contractor will ensure all construction equipment is equipped with appropriate noise attenuating devices.
3. The contractor will locate equipment staging areas that will create the greatest distance between construction-related noise/vibration sources and sensitive receptors nearest the project site during all project construction.
4. Idling equipment will be turned off when not in use.
5. Equipment will be maintained so that vehicles and their loads are secured from rattling and banging.
6. A 24-ft high noise barrier will be placed around the well where noted during well construction (see Exhibit G).
7. Nearby residences will be notified before 24-hour drilling and pavement cutting occurs.

Exhibit G  
 Proposed  
 Sound Wall Layout

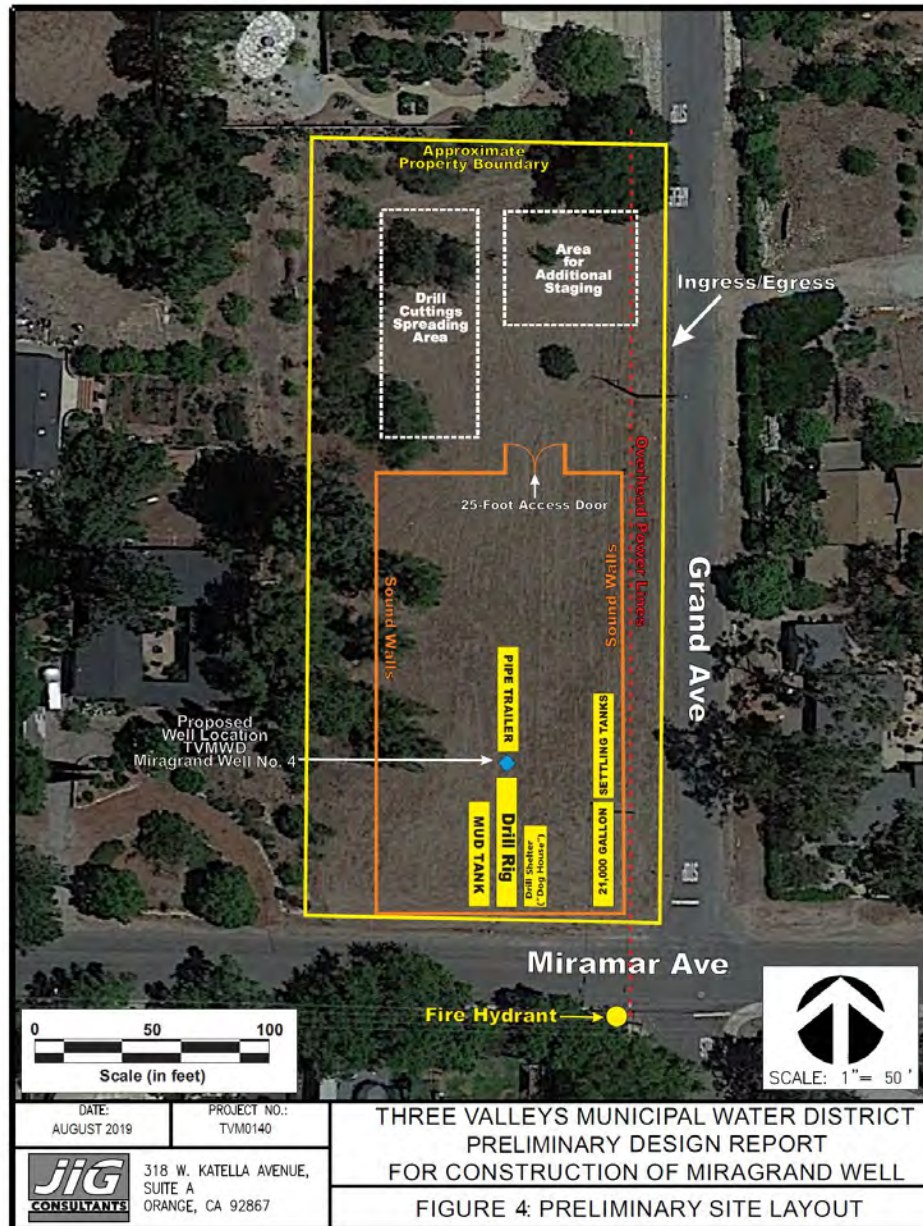

## **9.0    *References***

State of California General Plan Guidelines: 1998. Governor's Office of Planning and Research.

City of Claremont: General Plan Chapter 6 Safety and Noise Element. 2009.

City of Claremont: Noise Ordinance.

FHWA Noise Construction Handbook.

Appendix C Noise Impact History  
sub-Appendix A:

**Appendix A:**  
Photographs and Field Measurement Data

**24-Hour Continuous Noise Measurement Datasheet**

**Project:** Miramar & Grand      **Site Observations:** Meter was placed 90' from Miramar north of road Under a pine tree. From the meter location it was 133' west of Grand on the property line with a house on the west side.  
**Site Address/Location:** Intersection of Miramar and Grand Claremount, CA  
**Date:** 7/11/2019 to 7/12/2019  
**Field Tech/Engineer:** Jason Schuyler & Mike Dickerson, INCE

**General Location:**  
**Sound Meter:** LD 831      SN: 3713  
**Settings:** A-weighted, slow, 1-min, 1-hour interval, 24-hour duration  
**Meteorological Con.:** No wind, Sunny on 7/11 and 7/12  
**Site ID:** NM1

**Site Topo:** Flat  
**Ground Type:** street surface hard & Compacted

**Noise Source(s) w/ Distance:**

99' from Miramar Ave C/L  
133' West of Grand Ave C/L  
 \_\_\_\_\_  
 \_\_\_\_\_

**Figure 1: LT-1 Monitoring Location**

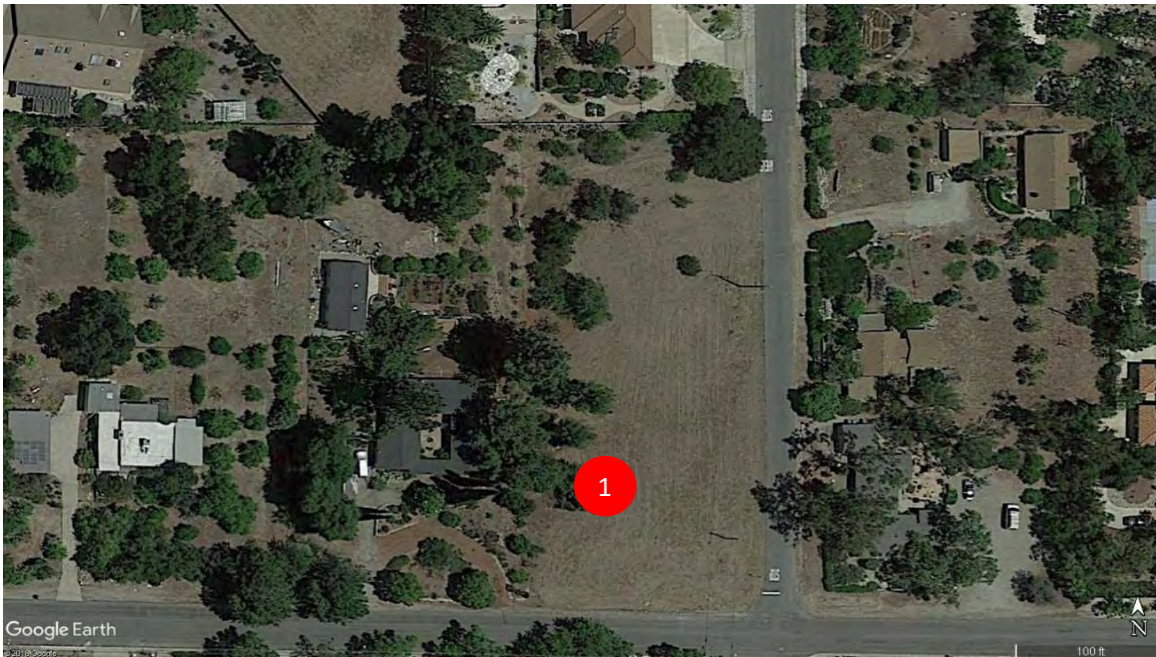

**Figure 2: LT-1 Photo**



**24-Hour Noise Measurement**

**Project:** Miramar & Grand **Day:** 1 of 1  
**Site Address/Location:** Intersection of Miramar and Grand Claremount, CA  
**Site ID:** LT-1

Date	Start	Stop	Leq	Lmax	Lmin	L2	L8	L25	L50	L90
6/11/2019	6:00 AM	7:00 AM	55.8	83.2	44.0	63.1	50.9	49.3	48.6	47.7
6/11/2019	7:00 AM	8:00 AM	57.4	72.1	40.3	68.1	59.8	57.1	56.7	53.1
6/11/2019	8:00 AM	9:00 AM	56.6	64.3	55.9	57.3	56.9	56.7	56.7	56.5
6/11/2019	9:00 AM	10:00 AM	52.2	71.4	37.0	60.1	56.5	56.1	48.8	44.2
6/11/2019	10:00 AM	11:00 AM	46.9	65.7	35.4	57.6	50.0	46.8	44.7	40.6
6/11/2019	11:00AM	12:00 PM	49.3	68.4	35.5	60.7	52.1	48.5	45.8	40.8
6/11/2019	12:00 PM	1:00 PM	53.1	76.0	36.7	64.5	53.6	49.0	46.3	41.7
6/11/2019	1:00 PM	2:00 PM	50.2	70.8	36.6	59.1	52.3	49.6	47.8	44.3
6/11/2019	2:00 PM	3:00 PM	48.2	71.0	36.8	57.2	48.1	45.6	44.2	41.8
6/11/2019	3:00 PM	4:00 PM	62.6	77.5	38.8	70.9	68.4	66.9	63.0	44.5
6/11/2019	4:00 PM	5:00 PM	47.2	65.4	38.5	58.7	49.7	46.3	44.7	42.5
6/11/2019	5:00 PM	6:00 PM	46.8	70.2	39.1	54.8	48.7	46.6	45.4	43.2
6/11/2019	6:00 PM	7:00 PM	45.1	59.7	39.0	52.8	48.2	46.1	44.8	42.8
6/11/2019	7:00 PM	8:00 PM	43.7	56.5	38.3	51.0	46.4	44.4	43.5	41.9
6/11/2019	8:00 PM	9:00 PM	44.6	57.1	39.4	51.4	47.1	45.3	44.5	43.1
6/11/2019	9:00 PM	10:00 PM	45.5	62.4	37.0	53.2	46.6	45.5	44.9	43.5
6/11/2019	10:00 PM	11:00 PM	57.2	85.0	37.6	60.2	44.8	43.4	42.9	41.9
6/11/2019	11:00 PM	12:00 AM	43.0	55.4	39.2	47.0	45.1	44.0	43.3	42.3
6/12/2019	12:00 AM	1:00 AM	48.2	58.9	41.1	53.4	51.1	49.7	48.8	47.3
6/12/2019	1:00 AM	2:00 AM	46.6	54.1	41.3	51.2	49.0	48.1	47.5	45.9
6/12/2019	2:00 AM	3:00 AM	46.9	54.0	42.1	51.9	49.4	47.7	46.9	45.6
6/12/2019	3:00 AM	4:00 AM	49.1	55.9	44.1	50.0	48.6	48.0	47.6	46.6
6/12/2019	4:00 AM	5:00 AM	50.7	69.9	45.6	52.2	51.1	50.4	49.8	48.7
6/12/2019	5:00 AM	6:00 AM	61.8	81.8	47.1	54.6	52.7	51.7	51.1	50.0

**CNEL:** 58.5

**24-Hour Continuous Noise Measurement Datasheet - Cont.**

**Project:** Miramar & Grand  
**Site Address/Location:** Intersection of Miramar and Grand Claremount, CA  
**Site ID:** LT-1

**Day:** 1 of 1

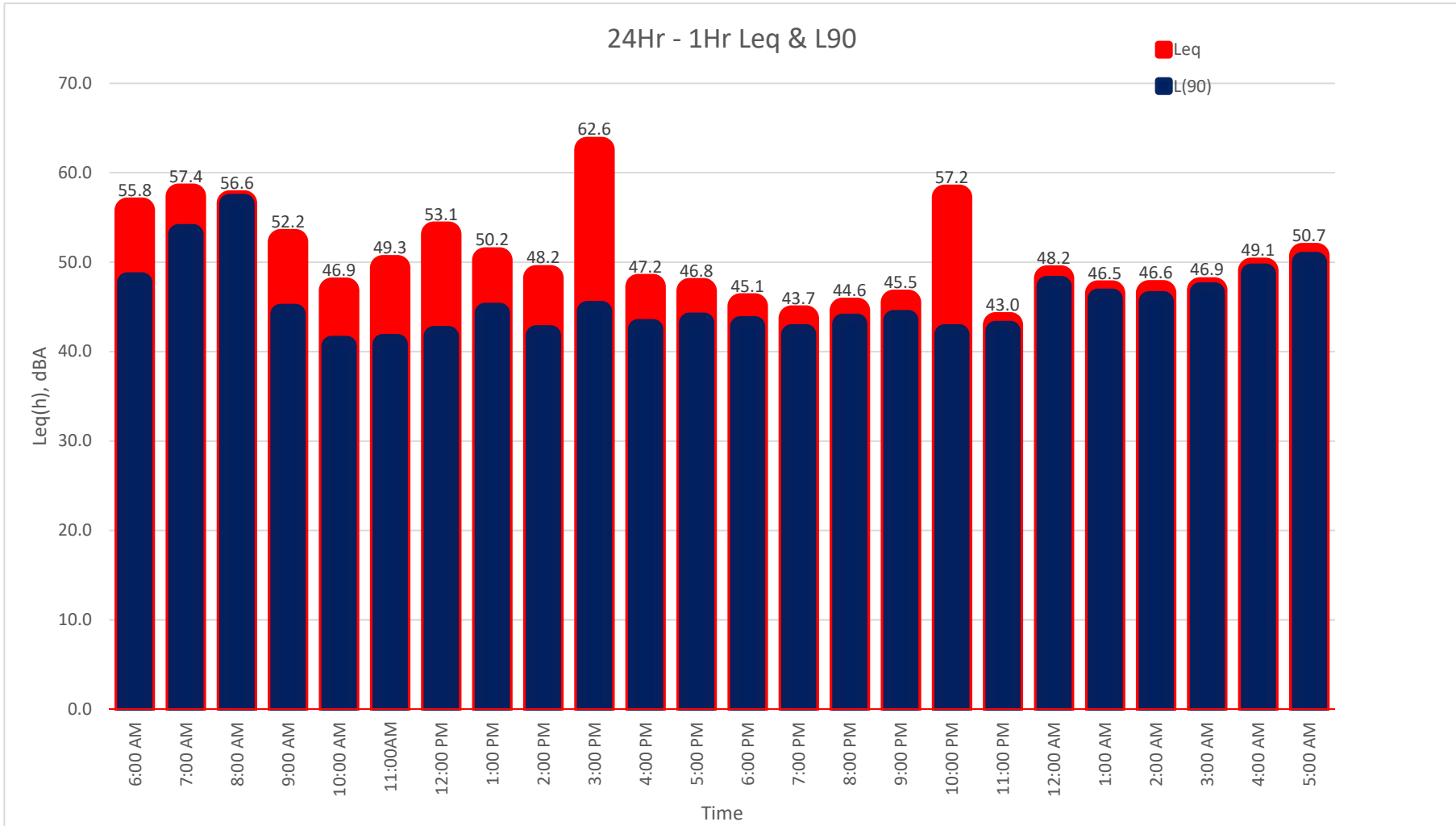

Appendix C Noise Impact History  
sub-Appendix B:

**Appendix B:**  
Well Motor Noise Measurements



**Project:** Town of Queen Creek, AZ  
**Site Location:** Hastings  
**Date:** 2/8/2019  
**Field Tech/Engineer:** Mike Dickerson, INCE  
**Source/System:** NIDEC Motor Corp

**Site Observations:**  
 Clear sky, measurements were performed within 3ft of source @ 54Hz.

**Location:** 3feet from motor  
**Sound Meter:** LD831c SN: 10685  
**Settings:** A-weighted, fast, 1-sec, 30-sec duration  
**Meteorological Cond.:** 77 degrees F, 2 mph wind

**Table 1: Summary Measurement Data**

Source	System	Overall dB(A)	3rd Octave Band Data (dBA)																														
			20	25	32	40	50	63	80	100	125	160	200	250	315	400	500	630	800	1K	1.25K	1.6K	2K	2.5K	3.15K	4K	5K	6.3K	8K	10K	12.5K	16K	20K
Well Pump Motor	Water Pump	90.2	25	22	29	35	42	41	50	52	53	53	58	66	65	67	65	64	66	67	78.2	89	82	72	74	63	66	59	57	52	49	41	35

**Figure 1: Example Measurement Position**

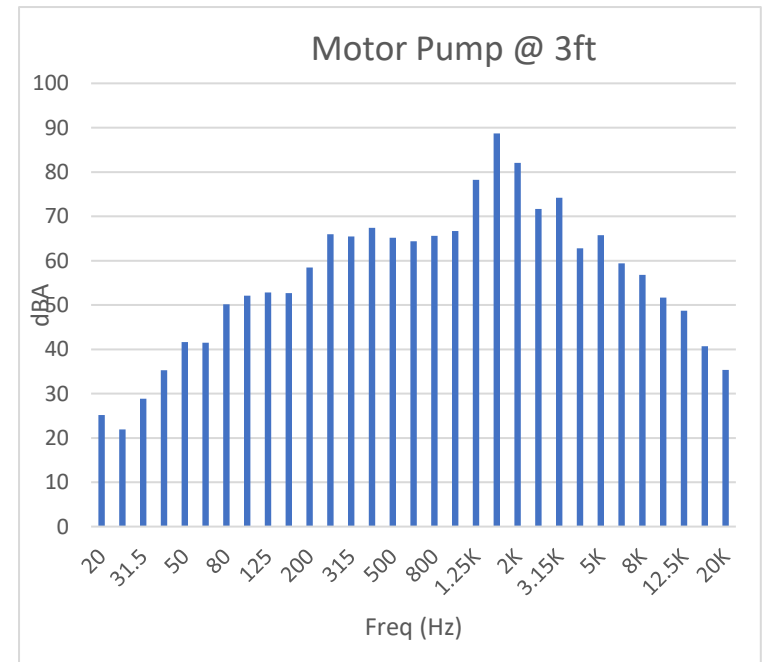

Appendix C Noise Impact History  
sub-Appendix C:

**Appendix C:**  
Construction Calculations

**Project:** Well Drilling Monitoring  
**Site Location:** Rittenhouse and Cherrywood Lane, QC, AZ  
**Date:** 5/16/2019  
**Field Tech/Engineer:** Robert Pearson  
**Source/System:** Drill / Casing Rig

**Site Observations:**  
 Clear sky, measurement was performed 10 feet from platform/rig.

**Location:** 10 feet from platform  
**Sound Meter:** NTi XL2 **SN:** A2A-05967-E0  
**Settings:** A-weighted, fast, 1-sec, 1-min duration  
**Meteorological Cond.:** 85 degrees F, 2 mph wind

**Table 1: Summary Measurement Data**

Source	System	Overall dB(A)	3rd Octave Band Data (dBA)																														
			20	25	32	40	50	63	80	100	125	160	200	250	315	400	500	630	800	1K	1.25K	1.6K	2K	2.5K	3.15K	4K	5K	6.3K	8K	10K	12.5K	16K	20K
Well Drilling	Platform/Rig	78.8	17	20	35	28	34	49	56	51	54	58	60	65	65	64	68	68	69	70	69.2	70	69	66	64	62	58	55	51	48	43	37	31

**Figure 1: Example Measurement Position**

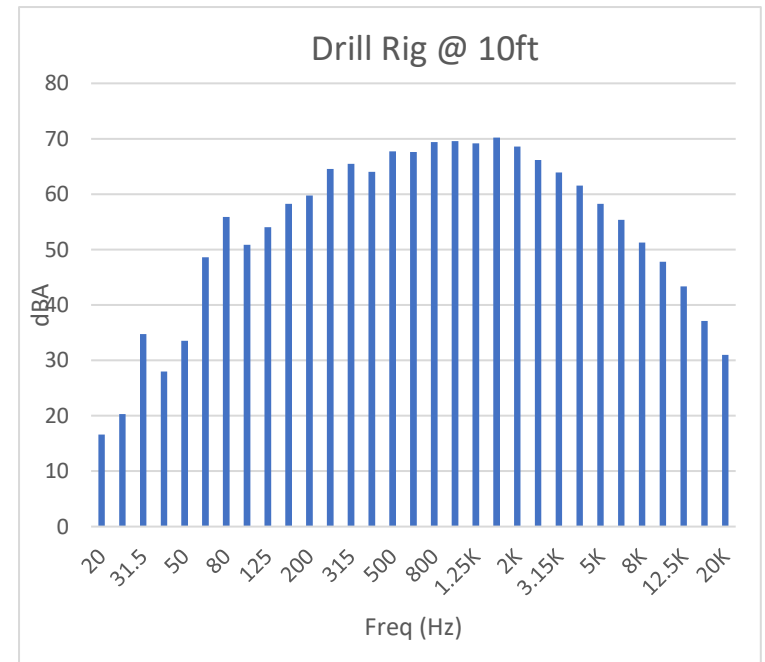
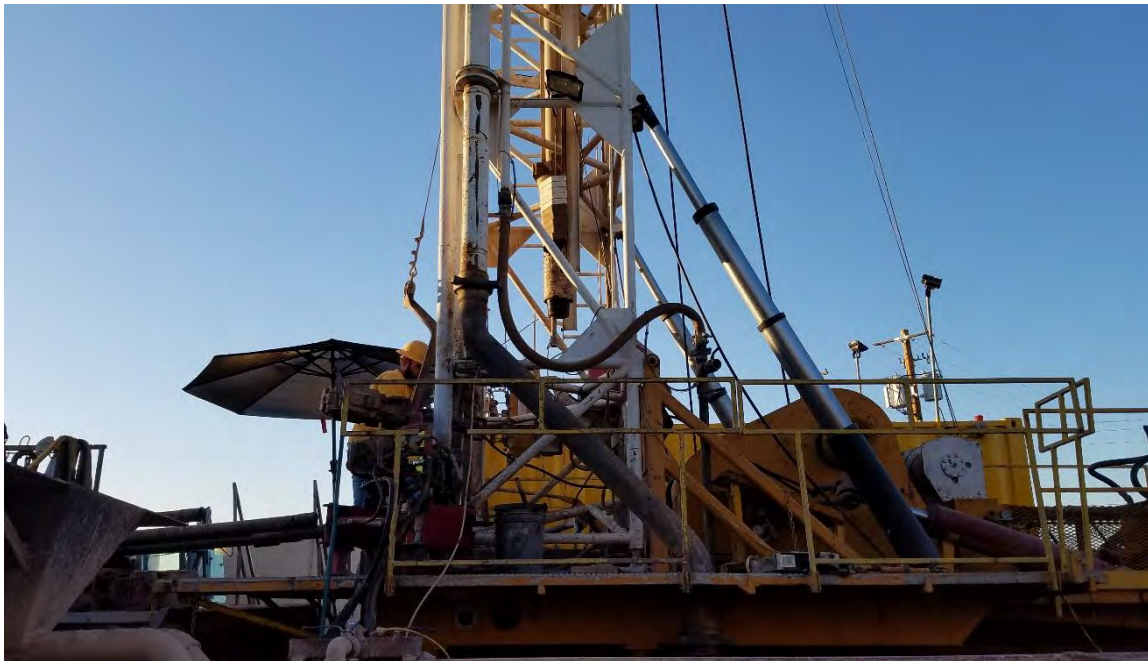

# Item 9 - Exhibit B

## Receptor - House

A	B	C	D	E	F	G	H	I	J
Construction Phase Equipment Item	# of Items	Item Lmax at 50 feet, dBA	Dist. To Recptr.	Item Usage Percent	Usage Factor	Dist. Correction dB	Usage Adj. dB	Recptr. Item Lmax, dBA	Recptr. Item Leq, dBA
<b>CUTTING</b>									
1. Backhoe	1	80	40	40	0.40	1.9	-4.0	81.9	78.0
2. Crane	1	85	40	16	0.16	1.9	-8.0	86.9	79.0
3. Pavement Cutter	1	85	40	20	0.20	1.9	-7.0	86.9	79.9
4. Water Truck	1	85	40	40	0.40	1.9	-4.0	86.9	83.0
5. Delivery/Dump Truck	2	84	40	40	0.80	1.9	-1.0	85.9	85.0
							Log Sum	93.1	88.8
<b>LAYING</b>									
1. Crane	1	85	40	16	0.16	1.9	-8.0	86.9	79.0
2. Delivery/Dump Truck	3	84	40	40	1.20	1.9	0.8	85.9	86.7
							Log Sum	89.5	87.4
<b>DRILLING</b>									
1. Drill Rig/Drilling Operations	1	69	100	40	0.40	-6.0	-4.0	63.0	59.0
									59.0
<b>PAVING</b>									
1. Paver	1	85	40	50	0.50	1.9	-3.0	86.9	83.9
2. Roller	1	85	40	20	0.20	1.9	-7.0	86.9	79.9
3. Delivery/Dump Truck	2	84	40	40	0.80	1.9	-1.0	85.9	85.0
							Log Sum	91.4	88.2
<b>BUILDING</b>									
1. Crane	1	85	100	16	0.16	-6.0	-8.0	79.0	71.0
2. Loader/Backhoe	1	80	100	40	0.40	-6.0	-4.0	74.0	70.0
3. Delivery/Dump Truck	2	84	100	40	0.80	-6.0	-1.0	78.0	77.0
							Log Sum	82.2	78.6

Appendix C Noise Impact History  
sub-Appendix D:

**Appendix D:**  
Vibration Calculations

**VIBRATION LEVEL IMPACT**

Project: Miragrand Well

Date: 8/26/19

Source: Drilling

Scenario: Unmitigated

Location: Project Site

Address:

PPV =  $PPV_{ref}(25/D)^n$  (in/sec)

**DATA INPUT**

Equipment = **3** Caisson Drilling INPUT SECTION IN BLUE  
 Type

PPVref = 0.089 Reference PPV (in/sec) at 25 ft.

D = **100.00** Distance from Equipment to Receiver (ft)

n = **1.10** Vibration attenuation rate through the ground

Note: Based on reference equations from Vibration Guidance Manual, California Department of Transportation, 2006, pgs 38-43.

**DATA OUT RESULTS**

PPV = **0.019** IN/SEC OUTPUT IN RED

**VIBRATION LEVEL IMPACT**

Project: Miragrand Well Date: 8/26/19  
 Source: Pipe Construction  
 Scenario: Unmitigated  
 Location: Project Site  
 Address:  
 PPV =  $PPV_{ref}(25/D)^n$  (in/sec)

**DATA INPUT**

Equipment = **4** Loaded Trucks INPUT SECTION IN BLUE  
 Type  
 PPVref = 0.076 Reference PPV (in/sec) at 25 ft.  
 D = **40.00** Distance from Equipment to Receiver (ft)  
 n = **1.10** Vibration attenuation rate through the ground

Note: Based on reference equations from Vibration Guidance Manual, California Department of Transportation, 2006, pgs 38-43.

**DATA OUT RESULTS**

PPV = **0.045** IN/SEC OUTPUT IN RED

APPENDIX E  
IS/MND COMMENTS AND RESPONSES







Gavin Newsom  
Governor

# Letter 1

STATE OF CALIFORNIA

Governor's Office of Planning and Research  
State Clearinghouse and Planning Unit

Item 9 - Exhibit B



Kate Gordon  
Director

October 29, 2019

**RECEIVED**

NOV 04 2019

**THREE VALLEYS MWD**

Ray Evangelista  
Three Valleys Municipal Water District  
1021 E. Miramar Avenue  
Claremont, CA 91711-2052

Subject: TVMWD Miragrand Groundwater Production Well  
SCH#: 2019099096

Dear Ray Evangelista:

The State Clearinghouse submitted the above named MND to selected state agencies for review. The review period closed on 10/28/2019, and the comments from the responding agency (ies) is (are) available on the CEQA database for your retrieval and use. If this comment package is not in order, please notify the State Clearinghouse immediately. Please refer to the project's ten-digit State Clearinghouse number in future correspondence so that we may respond promptly.

Please note that Section 21104(c) of the California Public Resources Code states that:

“A responsible or other public agency shall only make substantive comments regarding those activities involved in a project which are within an area of expertise of the agency or which are required to be carried out or approved by the agency. Those comments shall be supported by specific documentation.”

**Check the CEQA database for submitted comments for use in preparing your final environmental document: <https://ceqanet.opr.ca.gov/2019099096/2>.** Should you need more information or clarification of the comments, **we recommend that you contact the commenting agency directly.**

This letter acknowledges that you have complied with the State Clearinghouse review requirements for draft environmental documents, pursuant to the California Environmental Quality Act. Please contact the State Clearinghouse at (916) 445-0613 if you have any questions regarding the environmental review process.

Sincerely,

Scott Morgan  
Director, State Clearinghouse

cc: Resources Agency

**DEPARTMENT OF TRANSPORTATION**

DISTRICT 7 – Office of Regional Planning  
100 S. MAIN STREET, MS 16  
LOS ANGELES, CA 90012  
PHONE (213) 897-0475  
FAX (213) 897-1337  
TTY 711  
www.dot.ca.gov



*Making Conservation  
a California Way of Life.*

Governor’s Office of Planning & Research

**OCT 24 2019**

**STATE CLEARINGHOUSE**

October 24, 2019

Mr. Ray Evangelista  
Three Valleys Municipal Water District  
1021 E. Miramar Avenue  
Claremont, CA 91711

RE: TVMWD Miragrand Groundwater Production  
Well – Mitigated Negative Declaration  
(MND)  
SCH # 2019099096  
GTS # 07-LA-2019-02845  
Vic. LA-210/PM: R51.473

Dear Mr. Ray Evangelista:

Thank you for including the California Department of Transportation (Caltrans) in the environmental review process for the above referenced MND. The proposed project involves the construction of a new groundwater production well to be housed within an approximate 600-square-foot building and associated discharge pipeline to connect the well to the Three Valleys Municipal Water District (TVMWD) Miramar Treatment Plant located at 1021 E. Miramar Avenue. The purpose of the project is for the TVMWD to produce approximately 700 to 800 acre-feet per year (AFY) of groundwater to increase local water supplies and improve overall water supply reliability. The Three Valleys Municipal Water District is considered the Lead Agency under the California Environmental Quality Act (CEQA).

2-1

The nearest State facility to the proposed project is the Interstate 210 (I-210), which is located approximately a mile from the project. After reviewing the MND, Caltrans does not expect project approval to result in a direct adverse impact to the existing State transportation facilities.

The following information is included for your consideration.

As a reminder, Senate Bill 743 (2013) mandates that Vehicle Miles Traveled (VMT) be used as the primary metric in identifying transportation impacts of all future development projects under CEQA, starting July 1, 2020. For information on determining transportation impacts in terms of VMT on the State Highway System, see the Technical Advisory on Evaluating Transportation Impacts in CEQA by the California Governor’s Office of Planning and Research, dated December 2018: [http://opr.ca.gov/docs/20190122-743 Technical Advisory.pdf](http://opr.ca.gov/docs/20190122-743_Technical_Advisory.pdf).

2-2

If construction traffic is expected to cause delays on state facilities, please submit the Traffic Control Plan detailing the number of construction trips and potential mitigation measures for Caltrans’ review. Also, any transportation of heavy construction equipment and/or materials which requires use of oversized-transport vehicles on State highways will need a Caltrans transportation permit. Caltrans supports large size truck trips to be limited to off-peak commute periods to minimize congestion and ensure maximum safety conditions for pedestrians, cyclists, and motorists.

2-3

Mr. Ray Evangelista  
October 24, 2019  
Page 2 of 2

Finally, storm water run-off is a sensitive issue for Los Angeles county. Please be mindful that the project needs to be designed to discharge clean run-off water.

2-4

If you have any questions, please contact Emily Gibson, the project coordinator, at Emily.Gibson@dot.ca.gov, and refer to GTS# 07-LA-2019-02845.

Sincerely,



MIYA EDMONSON  
IGR/CEQA Branch Chief  
cc: Scott Morgan, State Clearinghouse

**Letter 2. California Department of Transportation (Caltrans), Ms. Miya Edmonson, IGR/CEQA Branch Chief, October 24, 2019**

- Comment 2-1 The comment provided a summary of the project description and stated that the nearest State facility is the 210 freeway located approximately 1 mile from the project site. Caltrans does not expect the project to result in a direct adverse impact to existing State transportation facilities.
- Response 2-1 Caltrans has indicated that no impacts to the freeway are anticipated, therefore, no response is necessary.
- Comment 2-2 The comment is a reminder that starting July 1, 2020, vehicle miles traveled (VMT) will be the primary metric in identifying transportation impacts on the State Highway System of all future development projects.
- Response 2-2 Per comment 1, Caltrans has indicated that no direct adverse impacts to the existing State transportation facilities is anticipated from the proposed project. Upon completion of construction, traffic associated with the operation of the well would be limited to periodic maintenance where one or two vehicles would access the site. Therefore, the VMT requirement would not apply to the operation of the Miragrand well.
- Comment 2-3 The comment is a request that if construction traffic is expected to cause delays on State facilities, a Traffic Control Plan must be submitted to Caltrans for review; oversized transport vehicles using State facilities will need a Caltrans transportation permit, and large size truck trips shall be limited to off-peak periods.
- Response 2-3 Construction of the proposed project is not anticipated to require oversized transport vehicles. Drilling and development of a new water well and related site construction can all be completed using equipment that can be transported by typical haul trucks and would not include oversized transport vehicles.
- Comment 2-4 The comment is a reminder that project development must be designed to discharge clean run-off water.
- Response 2-4 As outlined in the Initial Study project description, water produced during well development and pump testing activities will be directed (piped) to two or three 20,000 gallon Baker tanks to allow sediment to settle and reduce water turbidity below 100 nephelometric turbidity units (NTU) before allowing water to recharge onsite in an "earthen basin" and/or directing water towards an existing catch basin on Grand Avenue. If directed towards existing catch basin, TVMWD will convey the water into the Baker tanks and then into the newly constructed 8-inch discharge pipeline and fire hydrant. TVMWD will comply with requirements of its existing National Pollution Discharge Elimination System (NPDES) Discharge permit.

Letter 3



THE METROPOLITAN WATER DISTRICT  
OF SOUTHERN CALIFORNIA

October 14, 2019

VIA EMAIL AND USPS

Mr. Ray Evangelista  
Three Valleys Municipal Water District  
1021 East Miramar Avenue  
Claremont, CA 91711-2052

Dear Mr. Ray Evangelista:

Notice of Intent to Adopt a Mitigated Negative Declaration  
for the Three Valleys Municipal Water District Miragrand Production Well Project

The Metropolitan Water District of Southern California (Metropolitan) reviewed the Notice of Intent to Adopt a Mitigated Negative Declaration for the Three Valleys Municipal Water District (TVMWD) Miragrand Production Well Project (Project). The City of Claremont is acting as the Lead Agency under the California Environmental Quality Act (CEQA) for the Project. The Project consists of the construction of a new well, a discharge pipeline for connection to the nearby TVMWD Treatment Plant, and associated improvements (e.g., fencing, parking, landscaping, lighting, sidewalks). The project is generally located at the intersection of Grand and Miramar avenues in the City of Claremont. This letter contains Metropolitan’s response to the public notice as a potentially affected public agency.

3-1

Our review of the Notice indicates that Metropolitan owns and operates the Rialto Feeder and facilities near the proposed project location. Metropolitan’s Rialto Pipeline, which is a 96-inch inside-diameter precast concrete pipeline, runs in an east/west direction and is located on the southern boundary of the Project area. Metropolitan is concerned with potential impacts to the pipeline that may result from the construction and implementation of the proposed Project. We request that the City evaluate impacts of the proposed Project to Metropolitan’s existing facilities that occur within the project’s boundaries. The enclosed map shows these rights-of-way in relation to the proposed Project.

3-2

In order to avoid potential conflicts with Metropolitan’s rights-of-way, we require that any design plans for any activity in the area of Metropolitan’s pipelines or facilities be submitted for our review and written approval. Approval of the Project where it could impact Metropolitan’s property should be contingent on Metropolitan’s approval of design plans for the Project. Detailed prints of drawings of Metropolitan’s pipelines and rights-of-way may be obtained by calling Metropolitan’s Substructure Information Line at (213) 217-7663 or via email at EngineeringSubstructures@mwdh2o.com. To assist in preparing plans that are compatible with

3-3

THE METROPOLITAN WATER DISTRICT OF SOUTHERN CALIFORNIA

Mr. Ray Evangelista  
Page 2  
October 14, 2019

Metropolitan's facilities, easements, and properties, we have enclosed a copy of the "Guidelines for Developments in the Area of Facilities, Fee Properties, and/or Easements of The Metropolitan Water District of Southern California." Please note that all submitted designs or plans must clearly identify Metropolitan's facilities and rights-of-way.

3-3  
Con't

Additionally, Metropolitan encourages projects within its service area to include water conservation measures while Metropolitan continues to build new supplies and develop means for more efficient use of the current system. Water conservation, reclaimed water use, and groundwater recharge programs are integral components to regional water supply planning. Metropolitan supports mitigation measures such as using water efficient fixtures, drought-tolerant landscaping, and reclaimed water to offset any increase in water use associated with the proposed project.

3-4

We appreciate the opportunity to provide input to your planning process and we look forward to receiving future environmental documentation on this Project. Please contact Ms. Brenda Marines at (213) 217-7902 or [bmarines@mwdh2o.com](mailto:bmarines@mwdh2o.com) if you require assistance.

Very truly yours,



Sean Carlson  
Interim Team Manager, Environmental Planning Section

BSM:ds  
SharePoint\Three Valleys MWD - TVMWD Miragrand Production Well

Enclosures:

- (1) Project Map
- (2) Planning Guidelines

# TVMWD Miragrand Production Well Project

MWD Facilities: Rialto Pipeline

## Legend

 Approximate Project Location

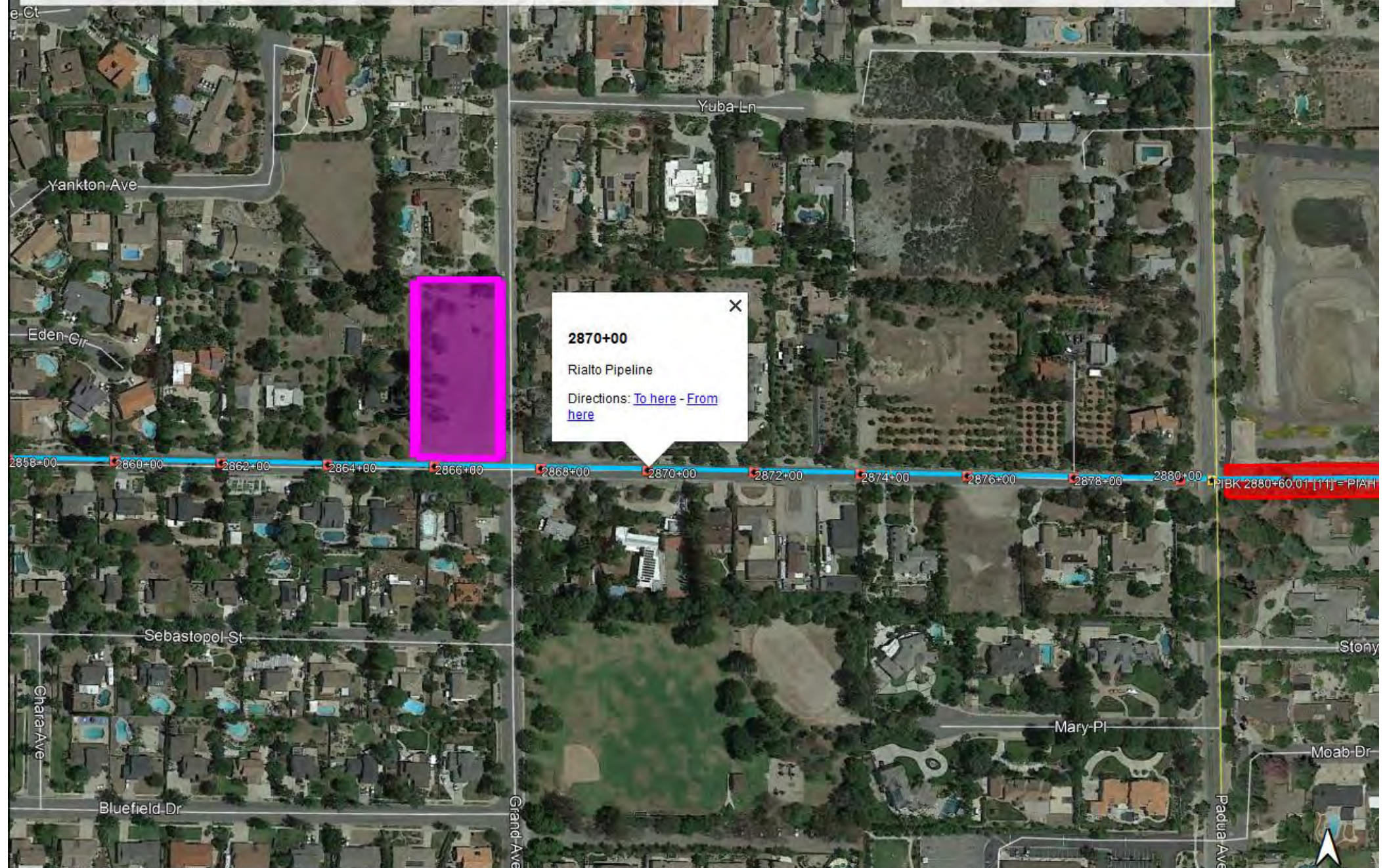

**2870+00**  
Rialto Pipeline  
Directions: [To here](#) - [From here](#)

PIBK 2880+60.01 [11] = PIAH



**Letter 3. Metropolitan Water District of Southern California, Mr. Sean Carlson, Interim Team Manager, Environmental Planning Section, October 14, 2019**

Comment 3-1 Metropolitan has provided a brief summary of their understanding of the project and identified the lead agency as the City of Claremont.

Response 3-1 The project summary is accurate, however, the lead agency is the Three Valleys Municipal Water District not the City of Claremont.

Comment 3-2 Metropolitan has provided a brief description of its Rialto Feeder and facilities, a portion of which are located in Miramar Avenue. Metropolitan has requested that the lead agency evaluate impacts of the proposed well project on its existing facilities.

Response 3-2 TVMWD is aware of the Rialto Feeder and facilities that are located proximate to the project site. The proposed project, including the construction of a pipeline to connect the new well to the existing 12-inch water line in Miramar Avenue that extends to TVMWD's Miramar Water Treatment Plant.

TVMWD will coordinate with Metropolitan and other water purveyors and/or dry utility providers whose facilities are also located underground within Miramar and/or Grand avenues in the vicinity of the project site, in order to ensure that all facilities are identified in order to avoid any issues.

Comment 3-3 Metropolitan requires that any design plans for any activity in the are of its pipelines or facilities be submitted for review and written approval. The comment also provided details on where to obtain prints of drawings of Metropolitan's pipelines and rights-of-way. A copy of Metropolitan's guidelines was included with the comment letter.

Response 3-3 At such time as the project goes into the design phase, the TVMWD project engineer will coordinate with Metropolitan regarding submittal of the design plans for those project elements that may affect Metropolitan's pipeline and facilities.

Comment 3-4 Metropolitan encourages projects within its service area to include water conservation measures.

Response 3-4 It is TVMWD's intent to landscape the project site with low-water usage, drought tolerant vegetation. The design drawings for the project will include a conceptual planting plan with the plant list.

**From:** Chris Veirs <cveirs@ci.claremont.ca.us>  
**Sent:** Monday, October 28, 2019 8:27 PM  
**To:** Ray M. Evangelista <revangelista@TVMWD.com>  
**Cc:** Ben Peralta <bperalta@tvmwd.com>; Brad Johnson <bjohnson@ci.claremont.ca.us>; Mari Tipping <mtipping@ci.claremont.ca.us>  
**Subject:** RE: Comments to NOA/NOI and Initial Study for the Miragrand Well Claremont, CA. 91711

Ray and Ben,

Thanks for following up on this notice. The City supports TVMWD's mission to provide safe and plentiful water for its customers and member agencies. With that said, we are disappointed to receive notice of the project only after the Initial Study was already completed. In the future we request that you set up a meeting with City Staff earlier in the process so that local requirements can be discussed in advance of preparing the CEQA document. There are many local standards that should be considered as you design this project.

The City's suggested revisions to the draft initial study are listed below.

1. **Design/historic resource Protection:** The property for the proposed well site is located in the Rural Residential Zoning District in the City of Claremont. From its inception, this district has been intended to facilitate development of single-family homes while retaining the historic and agricultural character of the area. The second paragraph of the intent section of the RR District (CMC Section 16.007.000) states that "All new development must be in harmony with the rural character of this area. The area's rural character is depicted by the presence of agricultural features such as citrus groves, barns, rock walls, **pump houses built of rock**, and other characteristics such as mountain vistas, **minimal outdoor artificial lighting**, narrow streets accompanied by equestrian, **pedestrian, and bike trails**, and **native landscaping**. **The lack of such urban features as curb and gutters, streetlights, and sidewalks** also contribute greatly to the rural character of this area." An additional feature of the district is its very large setbacks for all new development. These are designed to create an open, natural character for the area and allow sight lines to surrounding mountains.

Since 1987, all new development in the rural zone, including several utility structures, has been subject to design review procedures contained in the Rural Claremont Architectural and Landscape Standards (RCALS). As a result, the area has a very unique and distinctive character that could be impacted by the proposed TVWMD project. The City requests that a mitigation measure be added under the aesthetics section of the Initial Study that notes that the final design for the facility will comply with the RCALS so that it will fit with the special character of this historic district of the City. The City understands that the site plan and design described in the Initial Study is preliminary and asks that TVMWD work with the City to revise the design to be consistent with the RCALS, Rural Zoning District Development Standards (CMC Section 16.306) which include the larger setbacks that are required for new development in this zone. This will likely need to include the use of river rock on perimeter walls and perhaps on the pump house and historically referenced design that is consistent with previously approved utility structures in the area.

2. **Right of Way Improvement Standards:** In addition to the RCALS, the City has developed specialized right of way improvement standards to retain the rural and historic character of Rural Claremont. These standards include rocks swales and meandering pedestrian paths rather than typical sidewalks, curb and gutter. In addition, it is likely that at least one streetlight, a low simple “rural” light standard will need to be added near the intersection of Miramar and Grand to improve safety. All new development for more than 25 years has been required to install these improvements at the time land is developed in this zone. The City requests that a new mitigation measure be included under the Transportation Section that notes that the public right of way areas along the south and east edges of the property be developed to the City’s current right of way standards as opposed to the curb, gutter and sidewalk improvements that are described in the Initial Study. This mitigation measure should also be added to the Aesthetics section as installing these improvements will help to protect the unique and historic character of the Rural Claremont district.

4-2

3. **Lighting Standards:** Another major focus of the Rural district is to ensure that exterior lighting is minimized and designed appropriately to reinforce the historic and rural character of the area and minimize ambient light to preserve night sky viewing for the area. RCAL standards regarding lights encourage minimal, purpose oriented lights, that are located and screened to minimize impacts to adjacent properties. The City understands TVMWD’s need for security lighting and believes there is ample room to design project lighting that serves that need as well as the lighting standards of the RCALS. This will likely include the use of low-Kelvin LED light sources (maximum 3,000 K color temperature) placed on the new pump house structure or low light standards (12 feet or lower). These could be similar to the LED street lights that are currently used throughout the Rural District. In order to ensure that this is accomplished the City requests that a mitigation measure be added under the aesthetics section noting that the final design for lighting the facility be designed in accordance with the RCALS, so that it will fit with the character of this special, historic district of the City.

4-3

4. **Landscaping:** The RCALS require the planting of street trees at regular intervals along the public edge of newly developed properties. It also calls for minimization of impermeable surfaces over the entire site and recommends landscapes that are informal and climate appropriate. The City recognizes that TVMWD will be seeking to minimize maintenance costs and therefore the amount of planting and irrigation that is provided on the site and is happy to work with your facilities designers to plan a landscape that accomplishes this goal without significantly impacting the character of the Rural Claremont Zone.

4-4

Thank you for providing the City with this opportunity to comment on the Miragrand well project. You or your consultant are welcome to contact me directly if you have any additional questions regarding this information or other City requirements.

**Christopher Veirs, Principal Planner**  
City of Claremont | 207 Harvard Avenue | Claremont, CA 91711  
Ph. (909) 399-5486 | [cveirs@ci.claremont.ca.us](mailto:cveirs@ci.claremont.ca.us)

**Letter 4. City of Claremont, Mr. Chris Veers, Principal Planner, Planning Division, October 28, 2019**

Comment 4-1 The City has summarized the intent of its Rural Residential Zoning District development requirements including site and building design standards.

Response 4-1 TVMWD recognizes that the project site is located within a rural residential area and intends to be a good neighbor in that regard by limiting the size of the well site improvements to approximately 9,000 square feet as indicated in the Initial Study. The remaining area will be landscaped with drought tolerant plant and surrounded by a perimeter fence to provide security. It is TVMWD's intent to blend into the neighborhood and will take the City's comments into consideration.

Comment 4-2 The City has summarized the right-of-way standards for road improvements in the Rural Residential Zoning District.

Response 4-2 The Initial Study discusses the potential for TVMWD to construct a sidewalk, curb and gutter along the east and south sides of the project site. However, since the proposed project is still in the preliminary design stage, other perimeter treatments are being considered including the construction of rock swales and decomposed granite along the east and south sides of the project site rather than curb/gutter.

Comment 3 The City has summarized the lighting standards for the Rural Residential Zoning District.

Response 4-3 TVMWD recognizes that the project site is located within a rural residential area and intends to be a good neighbor in that regard. There will be no lighting along the perimeter of the site and building lighting will meet the intended purpose of security while maintaining a low profile, by directing site lighting (area around the building) downward and inward.

Comment 4-4 The City has summarized the landscaping standards for the Rural Residential Zoning District.

Response 4-4 It is TVMWD's intent to landscape the site with various drought tolerant and native plants. Conceptually, TVMWD intends to design the landscaped area with a combination of trees, shrubs, and ground cover. Ground cover would likely include a combination of low-lying plants and no vegetation cover such as decorative gravel. It is TVMWD's intent to blend into the neighborhood and will take the City's comments into consideration.

----- Original message -----

From: Sandra Grajeda <[sgrajeda@earthlink.net](mailto:sgrajeda@earthlink.net)>  
Date: 10/29/19 10:42 (GMT-08:00)  
To: "Ray M. Evangelista" <[revangelista@TVMWD.com](mailto:revangelista@TVMWD.com)>  
Cc: Me <[sgrajeda@earthlink.com](mailto:sgrajeda@earthlink.com)>  
Subject: Comments re proposed Miragrande well

Dear Mr. Evangelista,

I live at 685 Sebastopol St. which is on the NW corner of Sebastopol and Grand, just one block down from the proposed well site. I have specific concerns which I'll list below, but I also would like to say that I feel this project has not been conducted in a transparent way. We only learned that the lot had been sold to the water district because of it being used as a yard last summer. There never was any for sale sign on the property. I and my neighbors only became aware of the well project in the last 2 weeks, making it almost impossible to attend the meetings. Obviously this has been in the works for a long time and should have been publicized much earlier. The noise involved with the pipe extension last summer was horrendous, but I put up with it, as I thought it was a temporary situation. It sounded like bombs being dropped when the rocks were being crushed. Whereas I didn't object before, now that I am hearing of this well project, I will register my objection.

1) This land is zoned as residential. How can a commercial/industrial enterprise be legally built in the middle of a neighborhood? TVMWD is adjacent to open land on the east and south; why isn't this land being explored for a well? | 5-1

2) It does not appear that this well will produce that much water. I figured out that based on the average family usage, it would supply about 200 families water per year. This seems rather minimal, in view of the fact that only 10% of what you handle is local water and in view of the impact it will have on the neighborhood both temporarily and permanently. | 5-2

3) You say you do not know how far down you will have to drill. There is already a small well on that property. Can't you tell from that well where the water table is? | 5-3

4) You say the noise will not be significant. This is disingenuous. The noise facts listed in the proposal for CEQUA is creative argument. Perhaps the average noise level will be reasonable, but due to the spikes, and the drilling for 24 hours, the noise will be more than significant for the neighborhood. Right across from the lot lives Eleanor Pierson, who is almost 100 years old. She should not have to undergo this. | 5-4

5) I do intend to do what I can to fight this plan. However, should we be unsuccessful, the house covering the well needs to be more attractive, for example faced in rocks, as has been done on various utility buildings in Blaisdell Ranch. Also the fence should only be around the house, not the whole property. If the entire lot is surrounded by fencing; the look will be appropriate to an industrial zoning, not residential. The rest of the land should be open to the neighborhood to walk in, or just look at. Having a large property surrounded with iron fencing is not an attractive addition to the neighborhood. The grand well is not particularly attractive; it looks industrial, but it is right next to the freeway wall and sort of blends in. | 5-5

6) Also should this plan go forward, you need to monetarily compensate the surrounding neighbors for | 5-6

## Item 9 - Exhibit B

the nuisance. You also may need to put up people in hotels during the drilling, should they not be able to sleep and thus have their livelihoods impacted.

**5-6  
Con't**

You need to have more neighborhood involvement. Your 8:00 AM board meetings to do not foster this.

**5-7**

Sincerely,

SANDRA GRAJEDA

**Letter 5. Sandra Grajeda, resident at 685 Sebastopol Street, Claremont October 29, 2019**

Comment 5-1 This land is zoned as residential. How can a commercial/industrial enterprise be legally built in the middle of a neighborhood? TVMWD is adjacent to open land on the east and south; why isn't this land being explored for a well?

Response 5-1 There are other existing wells owned by Golden State Water Company located in similar residential areas in Claremont. As a special district, TVMWD is exempt from local building and zoning ordinances regarding the location or construction of facilities for the production, generation, storage, treatment, or transmission of water.

The land you are referring to is known as San Antonio Spreading Grounds (SASG), which consists of approximately 850 acres of private property owned by Pomona Valley Protective Association (PVPA). This land or portions of it have not been available for purchase to TVMWD. The subject property at 675 E Miramar Avenue is adjacent to TVMWD's existing infrastructure (i.e. water pipeline) that will convey the well water back to the Miramar Treatment Plant. TVMWD's has and continues to look for potential opportunities to purchase property to construct additional groundwater wells to enhance the use of local water resources in a sustainable and cost-effective manner. TVMWD recognizes that the project site is located within a rural residential area and intends to be a good neighbor in that regard by limiting the size of the well site improvements. TVMWD intends to landscape the property with drought tolerant plants and install a perimeter fence (for security) so the improvements will blend into the neighborhood.

Comment 5-2 It does not appear that this well will produce that much water. I figured out that based on the average family usage, it would supply about 200 families water per year. This seems rather minimal, in view of the fact that only 10% of what you handle is local water and in view of the impact it will have on the neighborhood both temporarily and permanently.

Response 5-2 Based on more recent well production data, TVMWD staff anticipates the production of the proposed Miragrand Well will be about 600 to 700 gpm which equates to an annual production of about 850 to 1000 acre-feet/year. This could supply about 2,500 families per year. The proposed Miragrand Well project would allow TVMWD to enhance the use of local water resources in a reliable, sustainable, and cost-effective manner which is in agreement with TVMWD's mission statement and goals.

- Comment 5-3 You say you do not know how far down you will have to drill. There is already a small well on that property. Can't you tell from that well where the water table is?
- Response 5-3 There is not an existing well on the property. The cylindrical concrete pipe that is visible above ground, located in the northeast corner of the property is an irrigation structure used to provide water to orange, lemon, and avocado trees. TVMWD staff anticipates the water table (static water level) is approximately 320 feet below ground surface. The actual design of the proposed well cannot be prepared until the depth of the ground water is confirmed and the characterization of the formation (soil) is determined during well drilling to identify the depths of the water bearing formations. TVMWD staff anticipates the depth of the well drilling will be approximately 800 feet.
- Comment 5-4 You say the noise will not be significant. This is disingenuous. The noise facts listed in the proposal for CEQUA is creative argument. Perhaps the average noise level will be reasonable, but due to the spikes, and the drilling for 24 hours, the noise will be more than significant for the neighborhood. Right across from the lot lives Eleanor Pierson, who is almost 100 years old. She should not have to undergo this.
- Response 5-4 The Noise Section of the Initial Study was based on a Noise Impact Study prepared specifically for the proposed project at this site. The Noise Study included a 24-hour noise measurement to establish the ambient environment over a typical weekday. With this data MD Acoustics was able to model the noise associated with well drilling, well development, and long-term operation and to establish the mitigation measures to reduce noise volumes at the property line. Measures identified in the Noise Study and then in the Initial Study are typical for the type of construction proposed. For example, the 24-foot high temporary sound walls that will be placed around the well site during well drilling construction are used during construction of wells but are also used to buffer the noise associated with construction of the light rail projects in Los Angeles and other transportation projects that are developed in populated areas. With regard to the issue of noise spikes during drilling; it is anticipated that the sound emanating from the drilling site during 24-hour drilling will be at a fairly consistent level. The Claremont noise ordinance does allow for occasional, short-term noise levels slightly above the noise threshold levels.
- Comment 5-5 I do intend to do what I can to fight this plan. However, should we be unsuccessful, the house covering the well needs to be more attractive, for example faced in rocks, as has been done on various utility buildings in



Blaisdell Ranch. Also, the fence should only be around the house, not the whole property. If the entire lot is surrounded by fencing; the look will be appropriate to an industrial zoning, not residential. The rest of the land should be open to the neighborhood to walk in, or just look at. Having a large property surrounded with iron fencing is not an attractive addition to the neighborhood. The grand well is not particularly attractive; it looks industrial, but it is right next to the freeway wall and sort of blends in.

Response 5-5 Regarding the material used to build the building, the most effective sound barrier would be concrete block that could be faced with rock. This will be considered during building design. With regard to fencing, the project site is a well site that must be kept secure. Fencing the site is most appropriate and a wrought iron fence with pilasters is being considered. This would allow neighbors to view the landscaped site and at the same time, keep the site secure. The type of fencing, landscaping and hardscape (e.g., decomposed granite) is conceptual at this time.

Comment 5-6 Also should this plan go forward, you need to monetarily compensate the surrounding neighbors for the nuisance. You also may need to put up people in hotels during the drilling, should they not be able to sleep and thus have their livelihoods impacted.

Response 5-6 With the exception of the 24-hour drilling phase of the project, it is TVMWD's intent to comply with the City's requirements for hours of construction which are 7 am to 6 pm Monday through Friday. Prior to the start of any construction activity on the site, a sign will be posted identifying the project and listing contact information for residents to call TVWMD with concerns or comments.

From: Mark Gosnell <[mjgosnell@hotmail.com](mailto:mjgosnell@hotmail.com)>  
Date: 10/29/19 07:35 (GMT-08:00)  
To: "Ray M. Evangelista" <[revangelista@TVMWD.com](mailto:revangelista@TVMWD.com)>  
Subject: comments regarding miragrand well

Mr Evangelista, Please acknowledge receipt of this email and comments, I tried to send last night but it kept failing.

Comments:

Why is the well being placed in a residential area when there is derelict land on the East side of Padua and above the 210 freeway?

6-1

If the well does go ahead, I believe it should be placed in the center of the lot so it is equal distance from all 4 of the most affected residents.

6-2

There should be a provision for compensation for nuisance: During the last 3 months of the work on Grand and Mirama the dust from the construction has had a detrimental effect on my pool equipment which needed extra filtration cleaning, air conditioning system cleaning, I have had to purchase a monthly car cleaning service as I use my car to take clients out, and it was so dusty and dirty that it needed to be cleaned on a regular basis, we also had to employ a cleaner to clean the inside of the house as there is so much dust. The noise from the truck's and equipment that started frequently as early as 6.30am but often 6am.

6-3

The dust and noise will continue for at least the next 2 years, which will mean I have to keep all of the above going.

6-4

**Letter 6 Mr. Mark Gosnell, Resident at 2495 Grand Avenue, Claremont October 29, 2019**

Comment 6-1 Why is the well being placed in a residential area when there is derelict land on the East side of Padua and above the 210 freeway?

Response 6-1 The land you are referring to as “derelict” is known as San Antonio Spreading Grounds (SASG), which consists of approximately 850 acres of private property owned by Pomona Valley Protective Association (PVPA). This land or portions of it have not been available for purchase to TVMWD. The subject property at 675 E Miramar Avenue is adjacent to TVMWD’s existing infrastructure (i.e. water pipeline) that will convey the well water back to the Miramar Treatment Plant. TVMWD has and continues to look for potential opportunities to purchase property to construct additional groundwater wells to enhance the use of local water resources in a sustainable and cost-effective manner. TVMWD recognizes that the project site is located within a rural residential area and intends to be a good neighbor in that regard by limiting the size of the well site improvements. TVMWD intends to landscape the property with drought tolerant plants and install a perimeter fence so the improvements will blend into the neighborhood.

Comment 6-2 If the well does go ahead, I believe it should be placed in the center of the lot, so it is equal distance from all 4 of the most affected residents.

Response 6-2 The proposed siting of the well will provide adequate access to operate and maintain the proposed well and also minimize the amount of new water piping required to connect the well to TVMWD’s existing water pipeline that will deliver the water to the Miramar Treatment Plant. The potential impact to residents will be minimal.

Comment 6-3 There should be a provision for compensation for nuisance: During the last 3 months of the work on Grand and Miramar the dust from the construction has had a detrimental effect on my pool equipment which needed extra filtration cleaning, air conditioning system cleaning, I have had to purchase a monthly car cleaning service as I use my car to take clients out, and it was so dusty and dirty that it needed to be cleaned on a regular basis, we also had to employ a cleaner to clean the inside of the house as there is so much dust. The noise from the truck's and equipment that started frequently as early as 6.30am but often 6am.

The dust and noise will continue for at least the next 2 years, which will mean I have to keep all the above going.

Response 6-3 With the exception of the 24-hour drilling phase of the project, it is TVMWD's intent to comply with the City's requirements for hours of construction which are 7 am to 6 pm Monday through Friday. Prior to the start of any construction activity on the site, a sign will be posted identifying the project and listing contact information for residents to call TVWMD with concerns or comments.

## Notice of Determination

## Appendix D

**To:**

Office of Planning and Research  
 U.S. Mail: Street Address:  
 P.O. Box 3044 1400 Tenth St., Rm 113  
 Sacramento, CA 95812-3044 Sacramento, CA 95814

County Clerk  
 County of: Los Angeles  
 Address: 12400 Imperial Highway  
Norwalk, CA 90650

**From:**

Public Agency: Three Valleys MWD  
 Address: 1021 E. Miramar Avenue  
Claremont, CA 91711  
 Contact: Ray Evangelista  
 Phone: 909-621-5568

Lead Agency (if different from above):  
 Address: \_\_\_\_\_  
 Contact: \_\_\_\_\_  
 Phone: \_\_\_\_\_

***SUBJECT: Filing of Notice of Determination in compliance with Section 21108 or 21152 of the Public Resources Code.***

State Clearinghouse Number (if submitted to State Clearinghouse): 2019099096

Project Title: TVMWD Miragrand Groundwater Production Well

Project Applicant: Three Valleys Municipal Water District

Project Location (include county): 675 E. Miramar Avenue, Claremont 91711, Los Angeles County

**Project Description:**

Construction of a new municipal groundwater production well to be housed within an approximate 600-square-foot single story building and associated discharge pipeline to connect the well to the Three Valleys Municipal Water District (TVMWD) Miramar Treatment Plant located at 1021 E. Miramar Avenue. The purpose of the project is for TVMWD to produce approximately 700 to 900 acre-feet per year (AFY) of groundwater for the purpose of enhancing the use of local water resources, improve overall water

This is to advise that the Three Valleys Municipal Water District has approved the above  
 Lead Agency or  Responsible Agency)

described project on Nov 20, 2019 and has made the following determinations regarding the above  
 (date)  
 described project.

1. The project [ will  will not] have a significant effect on the environment.
2.  An Environmental Impact Report was prepared for this project pursuant to the provisions of CEQA.  
 A Negative Declaration was prepared for this project pursuant to the provisions of CEQA.
3. Mitigation measures [ were  were not] made a condition of the approval of the project.
4. A mitigation reporting or monitoring plan [ was  was not] adopted for this project.
5. A statement of Overriding Considerations [ was  was not] adopted for this project.
6. Findings [ were  were not] made pursuant to the provisions of CEQA.

This is to certify that the final EIR with comments and responses and record of project approval, or the negative Declaration, is available to the General Public at:

Three Valleys Municipal Water District, 1021 E. Miramar Avenue, Claremont, CA 91711

Signature (Public Agency): \_\_\_\_\_ Title: \_\_\_\_\_

Date: November 20, 2019 Date Received for filing at OPR: \_\_\_\_\_

**MINUTES**  
**REGULAR BOARD OF DIRECTORS MEETING**  
**THREE VALLEYS MUNICIPAL WATER DISTRICT**

**Wednesday, October 2, 2019**

**8:00 a.m.**

**1. Call to Order**

The Board meeting was called to order at 8:00 a.m. at the District office located at 1021 East Miramar Avenue, Claremont, California. The presiding officer was President Bob Kuhn.

**2. Pledge of Allegiance**

The flag salute was led by President Bob Kuhn.

**3. Roll Call**

Roll call was taken with a quorum of the Board present.

**Directors Present**

Bob Kuhn, President  
 David De Jesus, Vice President  
 Brian Bowcock, Secretary  
 Joe Ruzicka, Treasurer  
 Carlos Goytia, Director  
 Denise Jackman, Director  
 John Mendoza, Director

**Staff Present**

Matt Litchfield, General Manager  
 Steve Kennedy, Legal Counsel  
 Nadia Aguirre, Executive Assistant  
 Liz Cohn, Senior Financial Analyst  
 Ray Evangelista, Engineering Assistant  
 Karen Harberson, Compliance Specialist  
 Kirk Howie, Chief Administrative Officer  
 Tim Kellett, Chief Water Resources Officer  
 Steve Lang, Chief Operations Officer  
 James Linthicum, Chief Finance Officer  
 Robert Peng, I.T. Manager  
 Ben Peralta, Project Manager

Guests present: Ted Ebenkamp, Walnut Valley Water District; Ed Hilden, Walnut Valley Water District; Erik Hitchman, Walnut Valley Water District; Tom Coleman, Rowland Water District; Tony Lima, Rowland Water District; Dave Warren, Rowland Water District; Ben Lewis, Golden State Water Company; Jennifer Stark, City of Claremont; Darron Poulsen, City of Pomona; Kelly Gardner, Main San Gabriel Basin Watermaster; Michael Arnold, Arnold & Associates, Inc.; Kristi Foy, Arnold & Associates, Inc.; Bryan Gruber, LSL CPA's; Joan Licari, Sierra Club.

**4. Additions to Agenda**

No additions to the agenda were requested.

**5. Reorder Agenda**

No reorder to the agenda was requested.

**6. Public Comment**

President Kuhn called for public comment. Dr. Joan Licari, Chair of the Sierra Club San Gabriel Valley Task Force, approached the lectern. The Sierra Club supports SB 307 signed by Governor Newsom. Dr. Licari opposes the Cadiz project and urges TVMWD to oppose the project.

**7. Presentations**

Mr. Michael Thomas of Pomona Valley America's Job Center, Mr. John Maltes of Bassett Adult School and Mr. Enrique Medina of Pomona Unified School District, gave a presentation on training opportunities in the water industry. Mr. Maltes advised that water distribution and water treatment courses are held at Bassett Adult School to prepare students for the state exam. Fifty percent of students are water district employees and the other fifty percent are trying to get in the water industry. The program aims to place students at water agencies. Mr. Medina is working on establishing a career pathway in water distribution and water treatment for 11<sup>th</sup> and 12<sup>th</sup> grade high school students. The program needs instructors and an accessible location for students.

President Kuhn asked for a meeting between Mr. Thomas, Mr. Maltes, Mr. Medina and staff to further discuss collaboration.

Mr. Mike Arnold and Ms. Kristi Foy, the Districts legislative lobbyists, updated the board on year end legislative activities. The 2019-20 legislative session is in the second year. Any bills not on Governor Newsom's desk by the end of this session officially become a two-year bill and will pick up in January 2020. The legislative session ended on September 13, 2019. The final report will be made available after October 13, 2019.

Governor Newsom proposed a water tax that would also have an impact on dairy and agriculture; however, an alternative was pushed for. As part of the final budget agreement \$130 million was designated for safe and affordable drinking water in disadvantaged communities. \$100 million is being funded from the Greenhouse Gas Reduction Fund and \$30 million from the state's General Fund. Finally, SB 200 passed and is funded until 2030.

Over 75 bills were tracked, with support on 8 bills, 3 of those being on the water fund. 8 bills were opposed and 4 of those bills were stopped.

## 8. General Manager's Report

### 8.A – FY 18-19 Audit and CAFR (Comprehensive Annual Financial Report)

The Board was asked to receive, approve and file the FY 2018-19 Audit and CAFR. Mr. Bryan Gruber of LSL CPA's presented the annual financial statement audit. The audit process was completed in August 2019 with the result of an unmodified opinion. The districts internal controls policies and procedures were reviewed and there were no instances of material weaknesses or significant deficiencies.

Upon motion and second, President Kuhn called for discussion. There being no discussion, President Kuhn called for the vote.

**Moved: Joe Ruzicka      Second: David De Jesus**  
**Motion No. 19-10-5243 – Approval of FY 18-19 Audit and CAFR**  
**Motion passed by a 7-0 unanimous vote.**

### 8.B – FY 18-19 Final Reserves Schedule

Mr. James Linthicum presented the FY 18-19 final reserves schedule. It is proposed to return \$3,713 to the capital asset reserves fund. There were eight projects that were not completed during the fiscal year and budget funds left over. It is proposed to carryforward \$2,276,692 to continue the projects and complete them during the current fiscal year. The final proposal is to place excess funds of \$213,436 into the general reserves fund.

Upon motion and second, President Kuhn called for discussion. There being no discussion, President Kuhn called for the vote.

**Moved: Joe Ruzicka      Second: Brian Bowcock**  
**Motion No. 19-10-5244 – Approval of FY 18-19 Final Reserves**  
**Schedule**  
**Motion passed by a 7-0 unanimous vote.**

### 8.C – Chino Basin Watermaster 2020 Optimum Basin Management Program Update (OBMPU) Progress Report, August 2019

Mr. Litchfield provided an update on the Chino Basin Watermaster 2020 OBMP. Listening Session #6 was held on September 11, 2019. Listening Sessions 7 and 8 will be held at a future date. The CEQA process will begin in early 2020 with completion by June 2020. OBMP updates will continue on a monthly basis as an informational item.

### 8.D – Non-Binding Letter of Intent with Metropolitan Water District of Southern California - Regional Recycled Water Project

Mr. Litchfield reported on a non-binding letter of intent with MWD regarding the regional recycled water project, otherwise known as the Carson Project. This will lead to MWD asking to enter into a future Memorandum of Understanding for participation



and collaboration on an advanced water treatment facility. The letter of intent is being worked on between TVMWD and MWD and will be brought back to the board upon completion.

#### **8.E – Resolution No. 19-10-DRAFT Records Retention Schedule and Policy Update**

The records retention schedule and policy were previously updated in April 2006. Changes have since taken place at the state level that require the district to update the schedule and policy. Legal counsel reviewed the draft retention schedule that was updated by staff and wrote the resolution and policy.

This item will be brought back to the October 16, 2019 Board meeting for consideration of approval.

#### **8.F – Geographic Information Systems (GIS) Project Update**

Mr. Robert Peng provided an update on the Geographic Information System implemented in June 2019. The system improves capabilities to access information, improve asset management capabilities and improve operational efficiencies. Currently the district is in the final stage of implementation which is support and maintenance. Mr. Peng gave an overview of Geo Viewer modules that are presently deployed: Field Redlining of Assets; View Images as Assets, Plants, and As-Built; Underground Service Alert (USA) DigAlert Module; Valve Exercise Module; and Daily Meter and Hydro Reads. Future GIS initiatives include internal business discovery meetings, data quality improvements, fully supported monthly sales and consumption reporting, valve exercising machine integration, maintenance work orders and financial system integration.

Board members had questions for Mr. Peng and thanked him for his work on this project.

#### **8.G – Proposed Service Connection Applications for PM-27 and PM-29**

Mr. Timothy Kellett informed the board of a proposed service connection application with MWD for PM-27 and PM-29 along the Rialto Pipeline. Proposed service connection PM-27 would provide the district with an alternative option to meet obligations in the Main San Gabriel Basin. Service connection PM-29 would deliver water into Thompson creek and the Central Basin, thus allowing the Puente Basin Water Agency (PBWA) to deliver additional groundwater recharge. TVMWD is working with MWD on an engineering report that will be done by MWD per their Administrative Code and will provide the project costs. There will be two costs for the project: the investigation and the actual project. The district is currently waiting for MWD to provide an official letter. The cost per connection is \$41,000, a total of \$82,000 for both investigations. TVMWD and PBWA will equally share the cost of the review.

Discussion regarding the details of the project ensued. Following discussion, staff was directed to return this item to a future board meeting.

### **8.H – MWD Solar Cup Update**

Mr. Kirk Howie provided an update on the MWD Solar Cup program coming up on November 2, 2019. TVMWD received an allocation of four high schools to sponsor. On September 12, schools were blindly drawn with the following being sponsored by TVMWD: San Dimas, Pomona, Nogales and Village Academy. Member agencies will also be assisting with their local schools. MWD has provided a timeline for schools to adhere to. The district will serve as the host site for all boat building and technical workshops.

## **9. Closed Session**

The Board convened into closed session at 10:02 a.m. to discuss the following items:

- Conference with Real Property Negotiators (Government Code Section 54956.8). Property: 1500 N. College Avenue, Claremont, California [District is considering purchase of a small portion (10,000 sq. ft.) of this parcel]. District Negotiator: Matthew Litchfield, General Manager. Negotiating Parties: Rancho Santa Ana Botanic Garden. Under Negotiation: Price and terms of payment.
- Conference with Legal Counsel – Anticipated Litigation. Significant exposure to litigation pursuant to Government Code Section 54956.9(d)(2). One potential case.

The Board reconvened to regular session at 10:47 a.m. No reportable action was taken during closed session.

## **10. Future Agenda Items**

None.

## **11. Adjournment**

The Board adjourned at 10:47 a.m. to its next regular Board meeting scheduled for Wednesday, October 16, 2019 at 8:00 a.m.

---

Bob Kuhn  
*President, Board of Directors*  
Three Valleys Municipal Water District

---

Recorded by: Nadia Aguirre  
Executive Assistant

9500

**MINUTES**  
**REGULAR BOARD OF DIRECTORS MEETING**  
**THREE VALLEYS MUNICIPAL WATER DISTRICT**

**Wednesday, October 16, 2019**  
**8:00 a.m.**

**1. Call to Order**

The Board meeting was called to order at 8:00 a.m. at the District office located at 1021 East Miramar Avenue, Claremont, California. The presiding officer was President Bob Kuhn.

**2. Pledge of Allegiance**

The flag salute was led by President Bob Kuhn.

**3. Roll Call**

Roll call was taken with a quorum of the Board present.

**Directors Present**

Bob Kuhn, President  
 David De Jesus, Vice President  
 Brian Bowcock, Secretary  
 Carlos Goytia, Director  
 Denise Jackman, Director

**Directors Absent**

Joe Ruzicka, Treasurer (excused)  
 John Mendoza, Director (excused)

**Staff Present**

Matt Litchfield, General Manager  
 Steve Kennedy, Legal Counsel  
 Dominique Aguiar, Operations Supervisor  
 Nadia Aguirre, Executive Assistant  
 Liz Cohn, Sr. Financial Analyst  
 Freeman Ensign, Operations Supervisor  
 Ray Evangelista, Engineering Assistant  
 Kirk Howie, Chief Administrative Officer  
 Tim Kellett, Chief Water Resources Officer  
 Steve Lang, Chief Operations Officer  
 Robert Peng, I.T. Manager  
 Ben Peralta, Project Manager

Guest present: Ted Ebenkamp, Walnut Valley Water District; Ed Hilden, Walnut Valley Water District; Erik Hitchman, Walnut Valley Water District; Brian Teuber, Walnut Valley Water District; Ben Lewis, Golden State Water; Tom Coleman, Rowland Water District; Tony Lima, Rowland Water District; Szu Pei Lu-Yang, Rowland Water District; Dave Warren, Rowland Water District; Darron Poulsen, City of Pomona; Kelly Gardner, Main San Gabriel Basin Watermaster; Lenet Pacheco, Valley County Water District; John Monsen, National Parks Conservation Association.

**4. Additions to Agenda**

No additions to the agenda were requested.

## 5. Reorder Agenda

No reorder to the agenda was requested.

## 6. Public Comment

President Kuhn called for public comment. Mr. John Monsen, National Parks Conservation Association, gave a statement in opposition to the Cadiz Project.

## 7. Consent Calendar

The Board was asked to consider consent calendar items (7.A-7.H) for the October 16, 2019 Board meeting that included: (7.A) Receive, Approve and File Minutes, September 4, 2019 and September 18, 2019; (7.B) Receive, Approve and File Financial Reports and Investment Update, September 2019; (7.C) Imported Water Sales, September 2019; (7.D) Miramar Operations Report, September 2019; (7.E) Approval of Resolution No. 19-10-863 Records Retention Schedule and Policy Update; (7.F) Cancellation of December 4, 2019 and January 1, 2020 Regular Board Meetings; (7.G) Approval of CY 2020 Holiday Schedule; (7.H) Approval of Resolution No. 19-10-864 Tax Sharing Exchange CLMD 1687, Annexation of Petition No. 78-718.

Upon motion and second, President Kuhn called for discussion. There being no discussion, President Kuhn called for the vote.

**Moved: Brian Bowcock Second: David De Jesus**  
**Motion No. 19-10-5245 – Approval of Consent Calendar Items 7.A – 7.H for October 16, 2019.**  
**Motion passed by a 5-0 vote; Directors John Mendoza and Joe Ruzicka were absent.**

## 8. General Manager's Report

### 8.A – Approve Director Expense Reports, September 2019

The Board was asked to consider approval of the director expense reports submitted for reimbursement for September 2019.

Upon motion and second, President Kuhn called for discussion. There being no further discussion, President Kuhn called for the vote.

**Moved: Brian Bowcock Second: Carlos Goytia**  
**Motion No. 19-10-5246 – Approval of Director Expense Reports for September 2019.**  
**Motion passed by a 5-0 vote; Directors John Mendoza and Joe Ruzicka were absent.**

**8.B – Proposed Service Connection Applications for PM-27 and PM-29**

The Board was provided an update on the proposed service connection applications with MWD for PM-27 and PM-29. TVMWD has received the official letter from MWD to move forward with the engineering study for both service connections. The district has also received a letter of commitment for co-funding for PM-29 from Puente Basin Water Agency (PBWA). The district will continue to work towards a construction phase with PBWA and Main San Gabriel Basin Watermaster.

**8.C – Approve Salary Schedule and Organizational Chart Update – Effective September 9, 2019**

Mr. Litchfield reported to the Board that the District's salary schedule and organizational chart require revision and Board approval due to a recent retirement of an employee. As a result of this retirement, the position of Conservation and Resource Analyst was eliminated from the salary schedule and organizational chart. Approval of the updated salary schedule and organizational chart are necessary to remain in compliance with CalPERS and California Code of Regulations Section 570.5.

Upon motion and second, President Kuhn called for discussion. There being no further discussion, President Kuhn called for the vote.

**Moved: Carlos Goytia    Second: Brian Bowcock**  
**Motion No. 19-10-5247 – Approval of Salary Schedule and Organizational Chart update effective September 9, 2019**  
**Motion passed by a 5-0 vote; Directors John Mendoza and Joe Ruzicka were absent from the vote.**

**9. Directors' / General Manager's Oral Reports**

Director Goytia – The SGV Council of Governments meeting was rescheduled to October 24, 2019.

Director Bowcock – SCWUA meeting will be held on October 17, 2019. Director Bowcock commended Director Mendoza for taking the T1/T2 test. Director Bowcock attended the SGV Water Forum Committee meeting on October 15, 2019. CA-NV AWWA is asking members to look through historical photos and identify people in the pictures.

Director De Jesus – two new directors were inducted at MWD: Vartan Gharpetian, representing Glendale and Tracy Quinn, representing Los Angeles. The Alliance for Water Efficiency is being co-funded by MWD on behalf of its member agencies beginning in 2020. Director De Jesus also reported that MWD is sponsoring proposed legislation with the State Water Resources Control Board to identify and evaluate drinking water quality constituents of emerging concern since the legislature is trying to set drinking water standards outside the normal USEPA process.

Director Kuhn – reported the federal budget has a line item of \$10-\$30 million for the Water Quality Authority dedicated to groundwater clean-up.

Mr. Litchfield reminded the Board of the upcoming TVMWD Leadership Breakfast on October 31, 2019 and the MWD Solar Cup boat building workshop will be held at TVMWD on Saturday November 2, 2019.

**10. Future Agenda Items**

President Kuhn requested a performance evaluation for the General Manager in December 2019.

**11. Adjournment**

The Board adjourned at 8:31 a.m. to its next regular meeting scheduled for Wednesday, November 6, 2019 at 8:00 a.m.

---

Bob Kuhn  
*President, Board of Directors*  
Three Valleys Municipal Water District

---

Recorded by: Nadia Aguirre  
Executive Assistant



**Board of Directors  
Staff Report**

**To:** TVMWD Board of Directors  
**From:** Matthew H. Litchfield, General Manager   
**Date:** November 20, 2019  
**Subject:** **Change in Cash and Cash Equivalents Report**

---

<input type="checkbox"/> <b>For Action</b>	<input type="checkbox"/> <b>Fiscal Impact</b>	<b>\$</b>
<input checked="" type="checkbox"/> <b>Information Only</b>	<input type="checkbox"/> <b>Funds Budgeted:</b>	

---

**Staff Recommendation:**

**No Action Necessary – Informational Item Only**

**Discussion:**

Attached for your review is the Change in Cash and Cash Equivalents Report for the period ending October 31, 2019.

**Strategic Plan Objective(s):**

3.1 – Utilize and comply with a set of financial policies to maintain TVMWD’s financial health

**Attachment(s):**

Exhibit A – Change in Cash and Cash Equivalents Report

**Meeting History:**

None

NA/LC

**CHANGE IN CASH AND CASH EQUIVALENTS REPORT**

October 1 through October 31, 2019

		<u>CASH</u>	<u>CASH EQUIVALENTS</u>
SUMMARY 10/31/2019			
	Petty Cash	6,000.00	
	Local Agency Investment Fund		1,029,905.80
	California Asset Management Program(CAMP)		11,458.95
	General Checking	1,300,000.00	
	Sweep Account	5,795,050.68	
	U.S. Bank	5,000.00	
	<b>TOTAL CASH IN BANKS &amp; ON HAND</b>	<b>\$ 7,106,050.68</b>	<b>\$ 1,041,364.75</b>
	TOTAL CASH IN BANKS & ON HAND 10/31/19	\$ 7,106,050.68	\$ 1,041,364.75
	TOTAL CASH IN BANKS & ON HAND 09/30/19	\$ 2,360,187.59	\$ 1,040,162.61
	<b>PERIOD INCREASE (DECREASE)</b>	<b>\$ 4,745,863.09</b>	<b>\$ 1,202.14</b>
CHANGE IN CASH POSITION DUE TO:			
	Water Sales/Charges Revenue	7,570,329.13	
	Interest Revenue	1,862.23	
	Subvention/RTS Standby Charge Revenue		
	Hydroelectric Revenue		
	Other Revenue	92,305.02	
	Cadiz Water Project Peer Review		
	Investment Xfer From Chandler Asset Mgt	5,560,000.00	
	LAIF Quarterly Interest		1,182.20
	California Asset Mgmt Program Interest		19.94
	Transfer To LAIF		
	Transfer From LAIF		
	INFLOWS	13,224,496.38	1,202.14
	Expenditures	(8,399,486.15)	
	Current Month Outstanding Payables	145,068.22	
	Prior Month Cleared Payables	(220,624.66)	
	Bank/FSA Svc Fees	(175.00)	
	HRA/HSA Payment	(3,415.70)	
	CalPERS Unfunded Accrued Liability		
	Investment Xfer to CA Asset Mgt Pgm		
	Transfer to LAIF		
	Transfer From CAMP		
	OUTFLOWS	(8,478,633.29)	-
	<b>PERIOD INCREASE (DECREASE)</b>	<b>4,745,863.09</b>	<b>1,202.14</b>





**THREE VALLEYS MUNICIPAL WATER DISTRICT**  
**CONSOLIDATED LISTING OF INVESTMENT PORTFOLIO**  
 October 31, 2019

ITEM	BOOK YIELD	BOOK VALUE	PAR VALUE	MARKET VALUE
Chandler Asset Management				
ABS - Asset Backed Securities	2.95%	275,469.90	275,479.90	278,606.43
Bonds - Agency	1.87%	1,814,167.02	1,800,000.00	1,835,287.77
Commercial Paper	0.00%	0.00	0.00	0.00
Money Market Fund	1.44%	3,430.31	3,430.31	3,430.31
Supranational	0.00%	0.00	0.00	0.00
US Corporate	2.81%	1,311,292.75	1,320,000.00	1,342,804.74
US Treasury	1.83%	1,204,052.52	1,200,000.00	1,214,621.44
	<b>2.19%</b>	<b>4,608,412.50</b>	<b>4,598,910.21</b>	<b>4,674,750.69</b>
Local Agency Invest Fund TVMWD	2.28%	1,029,905.80	1,029,905.80	1,029,905.80
California Asset Management Program	2.05%	11,458.95	11,458.95	11,458.95
<b>Reserve Fund</b>		<b>\$ 5,649,777.25</b>	<b>\$ 5,640,274.96</b>	<b>\$ 5,716,115.44</b>
Checking (Citizens)	0.65%	1,300,000.00	1,300,000.00	1,300,000.00
Sweep Account (Citizens)	0.40%	5,795,050.68	5,795,050.68	5,795,050.68
Emergency Checking (U.S. Bank)	0.00%	5,000.00	5,000.00	5,000.00
Petty Cash Fund	0.00%	6,000.00	6,000.00	6,000.00
<b>Working Cash</b>		<b>\$ 7,106,050.68</b>	<b>\$ 7,106,050.68</b>	<b>\$ 7,106,050.68</b>
<b>TOTAL PORTFOLIO</b>	<b>1.23%</b>	<b>\$ 12,755,827.93</b>	<b>\$ 12,746,325.64</b>	<b>\$ 12,822,166.12</b>

I certify that this report accurately reflects all investments of Three Valleys Municipal Water District and that all investments and this report are in conformity with Sections 53600 et seq of the California Government Code and the District's annual statement of investment policy (Resolution 19-02-845). The District's investment program herein shown provides sufficient cash flow and liquidity to meet all budgeted expenditures for the next six months.

MATTHEW H. LITCHFIELD, General Manager/Assistant Treasurer



# Three Valleys Municipal Water District - Account #10065

## MONTHLY ACCOUNT STATEMENT

OCTOBER 1, 2019 THROUGH OCTOBER 31, 2019

### Chandler Team:

For questions about your account, please call (800) 317-4747,  
or contact [operations@chandlerasset.com](mailto:operations@chandlerasset.com)

### Custodian

US Bank  
Christopher Isles  
(503) 464-3685

**CHANDLER ASSET MANAGEMENT**  
chandlerasset.com

*Information contained herein is confidential. We urge you to compare this statement to the one you receive from your qualified custodian. Please see Important Disclosures.*

**PORTFOLIO CHARACTERISTICS**

Average Modified Duration	2.40
Average Coupon	2.22%
Average Purchase YTM	2.19%
Average Market YTM	1.70%
Average S&P/Moody Rating	AA/Aa1
Average Final Maturity	2.68 yrs
Average Life	2.50 yrs

**ACCOUNT SUMMARY**

	Beg. Values as of 9/30/19	End Values as of 10/31/19
Market Value	10,179,183	4,674,751
Accrued Interest	45,130	24,887
<b>Total Market Value</b>	<b>10,224,313</b>	<b>4,699,638</b>
Income Earned	18,355	11,631
Cont/WD		-5,561,128
Par	10,059,652	4,598,910
Book Value	10,053,073	4,608,413
Cost Value	10,029,586	4,604,770

**TOP ISSUERS**

Government of United States	25.9%
Federal National Mortgage Assoc	13.6%
Federal Home Loan Bank	12.8%
Federal Home Loan Mortgage Corp	8.3%
Federal Farm Credit Bank	4.5%
Bank of America Corp	3.3%
John Deere ABS	3.2%
Paccar Financial	2.8%
<b>Total</b>	<b>74.5%</b>

**SECTOR ALLOCATION**

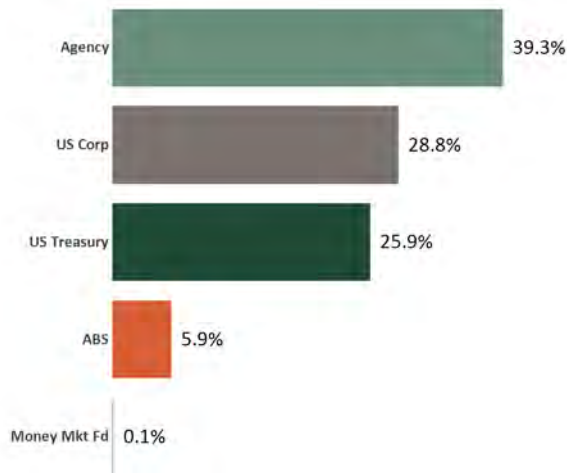

**MATURITY DISTRIBUTION**

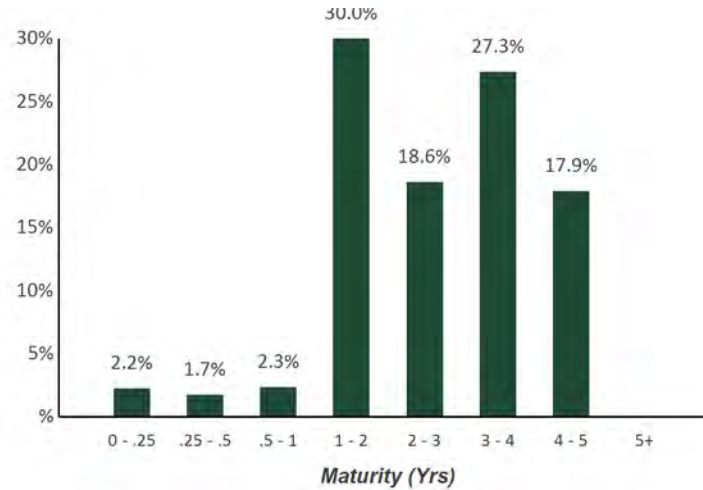

**CREDIT QUALITY (S&P)**

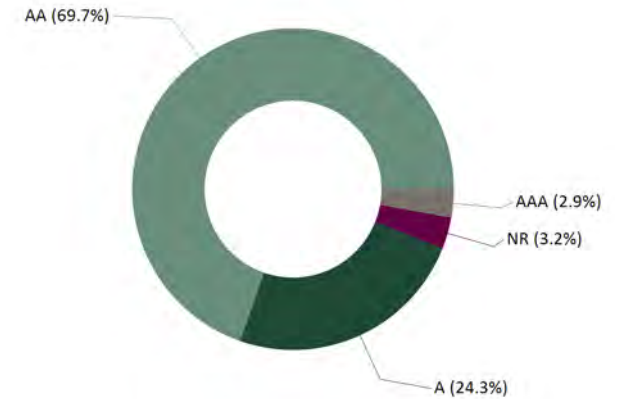

**PERFORMANCE REVIEW**

TOTAL RATE OF RETURN	Annualized									
	1M	3M	YTD	1YR	2YRS	3YRS	5YRS	10YRS	4/30/2009	
Three Valleys Municipal Water District	0.53%	1.45%	4.64%	6.08%	2.96%	2.15%	1.94%	1.97%	2.02%	
ICE BAML 1-5 Yr US Treasury/Agency Index	0.32%	1.25%	4.14%	5.79%	2.68%	1.80%	1.67%	1.68%	1.72%	

# Statement of Compliance

As of October 31, 2019

## Three Valleys Municipal Water District

Assets managed by Chandler Asset Management are in full compliance with state law and with the District's investment policy.

Category	Standard	Comment
Treasury Issues	No Limitation	Complies
Agency Issues	No Limitation	Complies
Municipal Securities/ Local Agency Bonds	Bonds issued by TVMWD; Issued by local agency within the state of California, including pooled investment accounts sponsored by the state of California, County Treasurers, or Joint Power Agencies	Complies
Supranationals	Issued by IBRD, IFC or IADB only; "AA" rated or higher by a NRSRO; 30% maximum; 10% max per issuer	Complies
Banker's Acceptances	"A" rated or higher by a NRSRO; 40% maximum; 5% max per issuer; 180 days max maturity	Complies
Commercial Paper	"A-1" rated or equivalent by a NRSRO; "A" rated issuer or equivalent by a NRSRO; 25% maximum; 5% max per issuer; 270 days max maturity; Issuer must be organized and operating within the US, have AUM >\$500 mil	Complies
Corporate Medium Term Notes	"A" rated or better by a NRSRO; 30% maximum; 5% max per issuer; Issued by corporations organized and operating within the U.S. or by depository institutions licensed by the U.S.	Complies
Negotiable Certificates of Deposit	30% maximum; 5% max per issuer	Complies
Certificates of Deposits/Time Deposit	Collateralized/ FDIC insured	Complies
Money Market Mutual Funds	"AAA" rated by 2 NRSROs; 20% maximum; 10% per fund	Complies
Mortgage Pass-throughs, CMOs and Asset Backed Securities	"AA" rated or higher by a NRSRO; "A" rated issuer or higher by a NRSRO; 20% maximum; 5% max per issuer	Complies
Local Agency Investment Fund - LAIF	Max program limitation	Complies
Repurchase Agreements	102% Collateralized; 1year max maturity	Complies
Reverse Repurchase Agreements	20% maximum; 92 days max maturity	Complies
Prohibited Securities	Inverse floaters; Ranges notes, Interest-only strips from mortgaged backed securities; Zero interest accrual securities	Complies
Max Per Issuer	5% of portfolio per issuer (except U.S. Government, Agencies/GSEs, Supranationals, Money Market Mutual Funds, LAIF, LGIP)	Complies
Maximum maturity	5 years	Complies

# Reconciliation Summary

As of October 31, 2019



BOOK VALUE RECONCILIATION		
<b>BEGINNING BOOK VALUE</b>		<b>\$10,053,073.17</b>
<b>Acquisition</b>		
+ Security Purchases	\$105,547.00	
+ Money Market Fund Purchases	\$5,380,890.31	
+ Money Market Contributions	\$0.00	
+ Security Contributions	\$0.00	
+ Security Transfers	\$0.00	
<b>Total Acquisitions</b>		<b>\$5,486,437.31</b>
<b>Dispositions</b>		
- Security Sales	\$5,439,291.83	
- Money Market Fund Sales	\$6,377.44	
- MMF Withdrawals	\$5,561,127.51	
- Security Withdrawals	\$0.00	
- Security Transfers	\$0.00	
- Other Dispositions	\$0.00	
- Maturities	\$0.00	
- Calls	\$0.00	
- Principal Paydowns	\$9,127.42	
<b>Total Dispositions</b>		<b>\$11,015,924.20</b>
<b>Amortization/Accretion</b>		
+/- Net Accretion	\$232.86	
		\$232.86
<b>Gain/Loss on Dispositions</b>		
+/- Realized Gain/Loss	\$84,593.36	
		\$84,593.36
<b>ENDING BOOK VALUE</b>		<b>\$4,608,412.50</b>

CASH TRANSACTION SUMMARY		
<b>BEGINNING BALANCE</b>		<b>\$190,044.95</b>
<b>Acquisition</b>		
Contributions	\$0.00	
Security Sale Proceeds	\$5,439,291.83	
Accrued Interest Received	\$25,663.71	
Interest Received	\$6,109.23	
Dividend Received	\$179.14	
Principal on Maturities	\$0.00	
Interest on Maturities	\$0.00	
Calls/Redemption (Principal)	\$0.00	
Interest from Calls/Redemption	\$0.00	
Principal Paydown	\$9,127.42	
<b>Total Acquisitions</b>	<b>\$5,480,371.33</b>	
<b>Dispositions</b>		
Withdrawals	\$5,561,127.51	
Security Purchase	\$105,547.00	
Accrued Interest Paid	\$311.46	
<b>Total Dispositions</b>	<b>\$5,666,985.97</b>	
<b>ENDING BOOK VALUE</b>		<b>\$3,430.31</b>

# Holdings Report

As of October 31, 2019

CUSIP	Security Description	Par Value/Units	Purchase Date Book Yield	Cost Value Book Value	Mkt Price Mkt YTM	Market Value Accrued Int.	% of Port. Gain/Loss	Moody/S&P Fitch	Maturity Duration
<b>ABS</b>									
89238BAB8	Toyota Auto Receivables Trust 2018-A A2A 2.1% Due 10/15/2020	8,651.83	01/23/2018 2.12%	8,650.95 8,651.52	100.00 3.18%	8,651.78 8.08	0.18% 0.26	Aaa / AAA NR	0.96 0.03
47788BAD6	John Deere Owner Trust 2017-B A3 1.82% Due 10/15/2021	11,828.07	07/11/2017 1.83%	11,827.21 11,827.67	99.91 2.06%	11,816.95 9.57	0.25% (10.72)	Aaa / NR AAA	1.96 0.40
47788CAC6	John Deere Owner Trust 2018-A A3 2.66% Due 4/18/2022	35,000.00	02/21/2018 2.68%	34,997.48 34,998.50	100.43 1.96%	35,149.10 41.38	0.75% 150.60	Aaa / NR AAA	2.47 0.60
43814UAG4	Honda Auto Receivables Trust 2018-2 A3 3.01% Due 5/18/2022	40,000.00	05/22/2018 3.03%	39,999.13 39,999.44	101.16 1.87%	40,465.64 43.48	0.86% 466.20	NR / AAA AAA	2.55 1.00
47788EAC2	John Deere Owner Trust 2018-B A3 3.08% Due 11/15/2022	100,000.00	07/18/2018 3.10%	99,992.42 99,994.65	101.25 1.95%	101,250.80 136.89	2.16% 1,256.15	Aaa / NR AAA	3.04 1.08
65479GAD1	Nissan Auto Receivables Trust 2018-B A3 3.06% Due 3/15/2023	80,000.00	07/17/2018 3.08%	79,997.41 79,998.12	101.59 1.89%	81,272.16 108.80	1.73% 1,274.04	Aaa / AAA NR	3.37 1.33
<b>Total ABS</b>		<b>275,479.90</b>	<b>2.95%</b>	<b>275,464.60</b> <b>275,469.90</b>	<b>1.96%</b>	<b>278,606.43</b> <b>348.20</b>	<b>5.94%</b> <b>3,136.53</b>	<b>Aaa / AAA</b> <b>AAA</b>	<b>2.88</b> <b>1.02</b>
<b>AGENCY</b>									
3135G0J20	FNMA Note 1.375% Due 2/26/2021	200,000.00	Various 1.41%	199,699.04 199,922.98	99.73 1.59%	199,450.20 496.53	4.25% (472.78)	Aaa / AA+ AAA	1.33 1.30
3135G0K69	FNMA Note 1.25% Due 5/6/2021	180,000.00	06/29/2016 1.18%	180,612.00 180,190.75	99.52 1.57%	179,136.36 1,093.75	3.83% (1,054.39)	Aaa / AA+ AAA	1.52 1.48
3137EAEC9	FHLMC Note 1.125% Due 8/12/2021	185,000.00	08/30/2016 1.33%	183,185.15 184,347.18	99.20 1.58%	183,528.51 456.72	3.91% (818.67)	Aaa / AA+ AAA	1.78 1.75
3135G0Q89	FNMA Note 1.375% Due 10/7/2021	160,000.00	10/27/2016 1.50%	159,025.60 159,618.88	99.63 1.57%	159,415.20 146.67	3.40% (203.68)	Aaa / AA+ AAA	1.94 1.90
3130AABG2	FHLB Note 1.875% Due 11/29/2021	100,000.00	12/28/2016 2.10%	98,970.00 99,564.72	100.67 1.55%	100,668.40 791.67	2.16% 1,103.68	Aaa / AA+ AAA	2.08 2.02
3135G0S38	FNMA Note 2% Due 1/5/2022	100,000.00	01/11/2017 2.02%	99,922.50 99,966.09	100.93 1.56%	100,930.20 644.44	2.16% 964.11	Aaa / AA+ AAA	2.18 2.11
3137EADB2	FHLMC Note 2.375% Due 1/13/2022	100,000.00	01/27/2017 2.03%	101,596.70 100,709.64	101.73 1.57%	101,731.40 712.50	2.18% 1,021.76	Aaa / AA+ AAA	2.21 2.13

CUSIP	Security Description	Par Value/Units	Purchase Date Book Yield	Cost Value Book Value	Mkt Price Mkt YTM	Market Value Accrued Int.	% of Port. Gain/Loss	Moody/S&P Fitch	Maturity Duration
<b>AGENCY</b>									
313379Q69	FHLB Note 2.125% Due 6/10/2022	100,000.00	09/28/2017 1.92%	100,903.00 100,501.26	101.38 1.58%	101,383.00 832.29	2.17% 881.74	Aaa / AA+ AAA	2.61 2.51
3133EAYP7	FFCB Note 1.95% Due 7/19/2022	100,000.00	07/28/2017 1.92%	100,138.00 100,075.39	101.25 1.48%	101,246.30 552.50	2.17% 1,170.91	Aaa / AA+ AAA	2.72 2.63
3137EAEN5	FHLMC Note 2.75% Due 6/19/2023	100,000.00	09/27/2018 3.03%	98,785.00 99,066.03	104.22 1.55%	104,217.80 1,008.33	2.24% 5,151.77	Aaa / AA+ AAA	3.64 3.43
313383YJ4	FHLB Note 3.375% Due 9/8/2023	100,000.00	02/26/2019 2.57%	103,413.00 102,903.32	106.57 1.61%	106,573.70 496.88	2.28% 3,670.38	Aaa / AA+ NR	3.86 3.61
3130AAHE1	FHLB Note 2.5% Due 12/8/2023	75,000.00	02/26/2019 2.55%	74,830.50 74,854.49	103.64 1.58%	77,732.70 744.79	1.67% 2,878.21	Aaa / AA+ NR	4.11 3.86
3133EDBU5	FFCB Note 3.5% Due 12/20/2023	100,000.00	01/16/2019 2.74%	103,486.00 102,927.62	107.85 1.53%	107,847.30 1,273.61	2.32% 4,919.68	Aaa / AA+ AAA	4.14 3.82
3130A1XJ2	FHLB Note 2.875% Due 6/14/2024	100,000.00	06/18/2019 1.96%	104,323.00 104,002.69	105.71 1.59%	105,714.30 1,094.10	2.27% 1,711.61	Aaa / AA+ NR	4.62 4.29
3130A2UW4	FHLB Note 2.875% Due 9/13/2024	100,000.00	10/21/2019 1.69%	105,547.00 105,515.98	105.71 1.65%	105,712.40 383.33	2.26% 196.42	Aaa / AA+ AAA	4.87 4.53
<b>Total Agency</b>		<b>1,800,000.00</b>	<b>1.87%</b>	<b>1,814,436.49</b> <b>1,814,167.02</b>	<b>1.57%</b>	<b>1,835,287.77</b> <b>10,728.11</b>	<b>39.28%</b> <b>21,120.75</b>	<b>Aaa / AA+</b> <b>AAA</b>	<b>2.69</b> <b>2.56</b>
<b>MONEY MARKET FUND FI</b>									
31846V203	First American Govt Obligation Fund Class Y	3,430.31	Various 1.44%	3,430.31 3,430.31	1.00 1.44%	3,430.31 0.00	0.07% 0.00	Aaa / AAA AAA	0.00 0.00
<b>Total Money Market Fund FI</b>		<b>3,430.31</b>	<b>1.44%</b>	<b>3,430.31</b> <b>3,430.31</b>	<b>1.44%</b>	<b>3,430.31</b> <b>0.00</b>	<b>0.07%</b> <b>0.00</b>	<b>Aaa / AAA</b> <b>AAA</b>	<b>0.00</b> <b>0.00</b>
<b>US CORPORATE</b>									
94974BGF1	Wells Fargo Corp Note 2.15% Due 1/30/2020	100,000.00	01/26/2015 2.18%	99,864.00 99,993.29	100.06 1.89%	100,062.90 543.47	2.14% 69.61	A2 / A- A+	0.25 0.25
22160KAGO	Costco Wholesale Corp Note 1.75% Due 2/15/2020	80,000.00	02/05/2015 1.77%	79,916.00 79,995.12	99.93 2.00%	79,941.76 295.56	1.71% (53.36)	Aa3 / A+ NR	0.29 0.29
857477AS2	State Street Bank Note 2.55% Due 8/18/2020	100,000.00	06/28/2017 1.86%	102,098.00 100,532.74	100.54 1.87%	100,537.20 517.08	2.15% 4.46	A1 / A AA-	0.80 0.78

# Holdings Report

As of October 31, 2019

CUSIP	Security Description	Par Value/Units	Purchase Date Book Yield	Cost Value Book Value	Mkt Price Mkt YTM	Market Value Accrued Int.	% of Port. Gain/Loss	Moody/S&P Fitch	Maturity Duration
<b>US CORPORATE</b>									
00440EAT4	Chubb INA Holdings Inc Callable Note Cont 10/3/2020 2.3% Due 11/3/2020	125,000.00	02/06/2017 2.16%	125,588.75 125,148.96	100.31 1.95%	125,387.13 1,421.53	2.70% 238.17	A3 / A A	1.01 0.90
084670BQ0	Berkshire Hathaway Callable Note Cont 2/15/2021 2.2% Due 3/15/2021	80,000.00	03/23/2018 2.69%	78,880.00 79,483.39	100.65 1.69%	80,517.68 224.89	1.72% 1,034.29	Aa2 / AA A+	1.37 1.27
91159HHP8	US Bancorp Callable Cont 12/23/2021 2.625% Due 1/24/2022	60,000.00	01/19/2017 2.66%	59,896.80 59,953.94	101.61 1.85%	60,967.98 424.38	1.31% 1,014.04	A1 / A+ AA-	2.24 2.07
44932HAC7	IBM Credit Corp Note 2.2% Due 9/8/2022	125,000.00	12/28/2017 2.60%	122,780.00 123,651.17	100.64 1.97%	125,794.88 404.86	2.69% 2,143.71	A2 / A NR	2.86 2.75
48128BAB7	JP Morgan Chase & Co Callable Note 1X 1/15/2022 2.972% Due 1/15/2023	125,000.00	10/30/2018 3.73%	121,335.00 122,207.73	101.94 2.07%	127,420.38 1,093.86	2.73% 5,212.65	A2 / A- AA-	3.21 2.61
808513AT2	Charles Schwab Corp Callable Note Cont 12/25/2022 2.65% Due 1/25/2023	125,000.00	06/01/2018 3.31%	121,453.75 122,529.13	102.04 1.98%	127,556.13 883.33	2.73% 5,027.00	A2 / A A	3.24 3.00
037833AK6	Apple Inc Note 2.4% Due 5/3/2023	125,000.00	11/29/2018 3.49%	119,456.25 120,609.62	101.79 1.87%	127,232.00 1,483.33	2.74% 6,622.38	Aa1 / AA+ NR	3.51 3.31
69371RP59	Paccar Financial Corp Note 3.4% Due 8/9/2023	125,000.00	09/10/2018 3.37%	125,177.50 125,136.39	104.93 2.03%	131,163.50 968.06	2.81% 6,027.11	A1 / A+ NR	3.78 3.52
06051GHF9	Bank of America Corp Callable Note 1X 3/5/2023 3.55% Due 3/5/2024	150,000.00	04/04/2019 3.08%	152,319.00 152,051.27	104.15 2.25%	156,223.20 828.33	3.34% 4,171.93	A2 / A- A+	4.35 3.14
<b>Total US Corporate</b>		<b>1,320,000.00</b>	<b>2.81%</b>	<b>1,308,765.05</b> <b>1,311,292.75</b>	<b>1.97%</b>	<b>1,342,804.74</b> <b>9,088.68</b>	<b>28.77%</b> <b>31,511.99</b>	<b>A1 / A</b> <b>A+</b>	<b>2.46</b> <b>2.16</b>
<b>US TREASURY</b>									
912828B90	US Treasury Note 2% Due 2/28/2021	180,000.00	04/26/2016 1.40%	185,056.07 181,387.77	100.54 1.59%	180,977.40 613.19	3.86% (410.37)	Aaa / AA+ AAA	1.33 1.31
912828Q37	US Treasury Note 1.25% Due 3/31/2021	100,000.00	12/13/2016 1.81%	97,683.93 99,237.82	99.52 1.59%	99,523.40 109.29	2.12% 285.58	Aaa / AA+ AAA	1.42 1.39
912828T34	US Treasury Note 1.125% Due 9/30/2021	185,000.00	11/09/2016 1.48%	181,871.52 183,774.90	99.17 1.57%	183,468.02 181.97	3.91% (306.88)	Aaa / AA+ AAA	1.92 1.88



# Holdings Report

As of October 31, 2019

CUSIP	Security Description	Par Value/Units	Purchase Date Book Yield	Cost Value Book Value	Mkt Price Mkt YTM	Market Value Accrued Int.	% of Port. Gain/Loss	Moody/S&P Fitch	Maturity Duration
<b>US TREASURY</b>									
912828J43	US Treasury Note 1.75% Due 2/28/2022	100,000.00	03/13/2017 2.14%	98,191.74 99,151.29	100.48 1.54%	100,484.40 298.08	2.14% 1,333.11	Aaa / AA+ AAA	2.33 2.27
912828N30	US Treasury Note 2.125% Due 12/31/2022	160,000.00	01/31/2018 2.54%	156,975.00 158,051.87	101.87 1.52%	162,987.52 1,145.65	3.49% 4,935.65	Aaa / AA+ AAA	3.17 3.04
9128284D9	US Treasury Note 2.5% Due 3/31/2023	200,000.00	04/29/2019 2.29%	201,578.13 201,374.11	103.23 1.52%	206,468.80 437.16	4.40% 5,094.69	Aaa / AA+ AAA	3.42 3.27
912828XT2	US Treasury Note 2% Due 5/31/2024	50,000.00	07/25/2019 1.83%	50,384.77 50,363.48	102.13 1.52%	51,062.50 420.77	1.10% 699.02	Aaa / AA+ AAA	4.59 4.34
912828XX3	US Treasury Note 2% Due 6/30/2024	225,000.00	08/26/2019 1.43%	230,932.62 230,711.28	102.07 1.54%	229,649.40 1,516.30	4.92% (1,061.88)	Aaa / AA+ AAA	4.67 4.42
<b>Total US Treasury</b>		<b>1,200,000.00</b>	<b>1.83%</b>	<b>1,202,673.78</b> <b>1,204,052.52</b>	<b>1.55%</b>	<b>1,214,621.44</b> <b>4,722.41</b>	<b>25.95%</b> <b>10,568.92</b>	<b>Aaa / AA+</b> <b>AAA</b>	<b>2.88</b> <b>2.76</b>
<b>TOTAL PORTFOLIO</b>		<b>4,598,910.21</b>	<b>2.19%</b>	<b>4,604,770.23</b> <b>4,608,412.50</b>	<b>1.70%</b>	<b>4,674,750.69</b> <b>24,887.40</b>	<b>100.00%</b> <b>66,338.19</b>	<b>Aa1 / AA</b> <b>AAA</b>	<b>2.68</b> <b>2.40</b>
<b>TOTAL MARKET VALUE PLUS ACCRUED</b>						<b>4,699,638.09</b>			

Transaction Type	Settlement Date	CUSIP	Quantity	Security Description	Price	Acq/Disp Yield	Amount	Interest Pur/Sold	Total Amount	Gain/Loss
<b>ACQUISITIONS</b>										
Purchase	10/01/2019	31846V203	179.14	First American Govt Obligation Fund Class Y	1.000	1.57%	179.14	0.00	179.14	0.00
Purchase	10/05/2019	31846V203	1,875.00	First American Govt Obligation Fund Class Y	1.000	1.57%	1,875.00	0.00	1,875.00	0.00
Purchase	10/07/2019	31846V203	1,100.00	First American Govt Obligation Fund Class Y	1.000	1.57%	1,100.00	0.00	1,100.00	0.00
Purchase	10/10/2019	31846V203	3,609,295.22	First American Govt Obligation Fund Class Y	1.000	1.57%	3,609,295.22	0.00	3,609,295.22	0.00
Purchase	10/10/2019	31846V203	2,446.88	First American Govt Obligation Fund Class Y	1.000	1.57%	2,446.88	0.00	2,446.88	0.00
Purchase	10/11/2019	31846V203	1,756,179.30	First American Govt Obligation Fund Class Y	1.000	1.57%	1,756,179.30	0.00	1,756,179.30	0.00
Purchase	10/15/2019	31846V203	204.00	First American Govt Obligation Fund Class Y	1.000	1.57%	204.00	0.00	204.00	0.00
Purchase	10/15/2019	31846V203	256.67	First American Govt Obligation Fund Class Y	1.000	1.57%	256.67	0.00	256.67	0.00
Purchase	10/15/2019	31846V203	77.58	First American Govt Obligation Fund Class Y	1.000	1.57%	77.58	0.00	77.58	0.00
Purchase	10/15/2019	31846V203	1,270.10	First American Govt Obligation Fund Class Y	1.000	1.57%	1,270.10	0.00	1,270.10	0.00
Purchase	10/15/2019	31846V203	7,906.09	First American Govt Obligation Fund Class Y	1.000	1.57%	7,906.09	0.00	7,906.09	0.00
Purchase	10/18/2019	31846V203	100.33	First American Govt Obligation Fund Class Y	1.000	1.57%	100.33	0.00	100.33	0.00
Purchase	10/22/2019	3130A2UW4	100,000.00	FHLB Note 2.875% Due 9/13/2024	105.547	1.69%	105,547.00	311.46	105,858.46	0.00
<b>Subtotal</b>			<b>5,480,890.31</b>				<b>5,486,437.31</b>	<b>311.46</b>	<b>5,486,748.77</b>	<b>0.00</b>
<b>TOTAL ACQUISITIONS</b>			<b>5,480,890.31</b>				<b>5,486,437.31</b>	<b>311.46</b>	<b>5,486,748.77</b>	<b>0.00</b>

**DISPOSITIONS**

Transaction Type	Settlement Date	CUSIP	Quantity	Security Description	Price	Acq/Disp Yield	Amount	Interest Pur/Sold	Total Amount	Gain/Loss
<b>DISPOSITIONS</b>										
Sale	10/10/2019	3130A1XJ2	110,000.00	FHLB Note 2.875% Due 6/14/2024	106.230	1.49%	116,853.00	1,019.03	117,872.03	2,418.94
Sale	10/10/2019	3130A7CV5	140,000.00	FHLB Note 1.375% Due 2/18/2021	99.702	1.60%	139,582.80	278.06	139,860.86	-339.98
Sale	10/10/2019	3130A8QS5	185,000.00	FHLB Note 1.125% Due 7/14/2021	99.337	1.51%	183,773.45	497.19	184,270.64	-595.58
Sale	10/10/2019	3130AABG2	100,000.00	FHLB Note 1.875% Due 11/29/2021	100.798	1.49%	100,798.00	682.29	101,480.29	1,245.90
Sale	10/10/2019	313379Q69	100,000.00	FHLB Note 2.125% Due 6/10/2022	101.708	1.47%	101,708.00	708.33	102,416.33	1,195.16
Sale	10/10/2019	313383YJ4	90,000.00	FHLB Note 3.375% Due 9/8/2023	107.162	1.48%	96,445.80	270.00	96,715.80	3,791.96
Sale	10/10/2019	3133EAYP7	125,000.00	FFCB Note 1.95% Due 7/19/2022	100.756	1.67%	125,945.00	548.44	126,493.44	848.67
Sale	10/10/2019	3133EDBU5	125,000.00	FFCB Note 3.5% Due 12/20/2023	107.693	1.60%	134,616.25	1,336.81	135,953.06	5,903.41
Sale	10/10/2019	3135G0F73	200,000.00	FNMA Note 1.5% Due 11/30/2020	99.771	1.70%	199,542.00	1,083.33	200,625.33	412.86
Sale	10/10/2019	3135G0N82	185,000.00	FNMA Note 1.25% Due 8/17/2021	99.516	1.52%	184,104.60	340.45	184,445.05	-787.22
Sale	10/10/2019	3135G0S38	100,000.00	FNMA Note 2% Due 1/5/2022	101.089	1.50%	101,089.00	527.78	101,616.78	1,123.85
Sale	10/10/2019	3135G0T45	200,000.00	FNMA Note 1.875% Due 4/5/2022	101.028	1.45%	202,056.00	52.08	202,108.08	1,999.70
Sale	10/10/2019	3135G0T94	200,000.00	FNMA Note 2.375% Due 1/19/2023	102.917	1.46%	205,834.00	1,068.75	206,902.75	9,613.75
Sale	10/10/2019	3137EADB2	100,000.00	FHLMC Note 2.375% Due 1/13/2022	101.929	1.50%	101,929.00	573.96	102,502.96	1,199.94
Sale	10/10/2019	3137EAEK1	200,000.00	FHLMC Note 1.875% Due 11/17/2020	100.224	1.67%	200,448.00	1,489.58	201,937.58	824.81
Sale	10/10/2019	3137EAEN5	90,000.00	FHLMC Note 2.75% Due 6/19/2023	104.621	1.46%	94,158.90	763.13	94,922.03	5,013.41

Transaction Type	Settlement Date	CUSIP	Quantity	Security Description	Price	Acq/Disp Yield	Amount	Interest Pur/Sold	Total Amount	Gain/Loss
<b>DISPOSITIONS</b>										
Sale	10/10/2019	9128282P4	200,000.00	US Treasury Note 1.875% Due 7/31/2022	101.184	1.44%	202,367.19	723.51	203,090.70	2,480.16
Sale	10/10/2019	912828J43	115,000.00	US Treasury Note 1.75% Due 2/28/2022	100.688	1.46%	115,790.63	221.15	116,011.78	1,791.91
Sale	10/10/2019	912828N89	155,000.00	US Treasury Note 1.375% Due 1/31/2021	99.676	1.63%	154,497.46	411.19	154,908.65	-462.11
Sale	10/10/2019	912828P87	100,000.00	US Treasury Note 1.125% Due 2/28/2021	99.336	1.61%	99,335.94	123.63	99,459.57	314.35
Sale	10/10/2019	912828Q37	110,000.00	US Treasury Note 1.25% Due 3/31/2021	99.492	1.60%	109,441.41	37.57	109,478.98	315.55
Sale	10/10/2019	912828W48	230,000.00	US Treasury Note 2.125% Due 2/29/2024	102.977	1.42%	236,846.09	537.09	237,383.18	9,511.02
Sale	10/10/2019	912828XR6	205,000.00	US Treasury Note 1.75% Due 5/31/2022	100.801	1.44%	206,641.60	1,293.85	207,935.45	2,131.08
Sale	10/10/2019	912828XT2	175,000.00	US Treasury Note 2% Due 5/31/2024	102.652	1.41%	179,641.60	1,262.30	180,903.90	3,352.71
Sale	10/11/2019	02665WCQ2	135,000.00	American Honda Finance Note 3.625% Due 10/10/2023	106.574	1.91%	143,874.90	13.59	143,888.49	8,963.41
Sale	10/11/2019	084670BQ0	50,000.00	Berkshire Hathaway Callable Note Cont 2/15/2021 2.2% Due 3/15/2021	100.698	1.67%	50,349.00	79.44	50,428.44	685.44
Sale	10/11/2019	166764BG4	135,000.00	Chevron Corp Callable Note Cont 4/15/2021 2.1% Due 5/16/2021	100.601	1.70%	135,811.35	1,141.87	136,953.22	2,464.43
Sale	10/11/2019	24422ETL3	125,000.00	John Deere Capital Corp Note 2.65% Due 1/6/2022	101.928	1.77%	127,410.00	874.13	128,284.13	1,094.64
Sale	10/11/2019	30231GAV4	120,000.00	Exxon Mobil Corp Callable Note Cont 2/1/2021 2.222% Due 3/1/2021	100.740	1.68%	120,888.00	296.27	121,184.27	277.51
Sale	10/11/2019	369550BE7	135,000.00	General Dynamics Corp Note 3% Due 5/11/2021	101.995	1.72%	137,693.25	1,687.50	139,380.75	3,077.59
Sale	10/11/2019	40428HPV8	150,000.00	HSBC USA Inc Note 2.75% Due 8/7/2020	100.601	2.01%	150,901.50	733.33	151,634.83	1,610.01

Transaction Type	Settlement Date	CUSIP	Quantity	Security Description	Price	Acq/Disp Yield	Amount	Interest Pur/Sold	Total Amount	Gain/Loss
<b>DISPOSITIONS</b>										
Sale	10/11/2019	4581X0CW6	200,000.00	Inter-American Dev Bank Note 2.125% Due 1/18/2022	101.312	1.53%	202,624.00	979.86	203,603.86	2,538.90
Sale	10/11/2019	45950KCJ7	215,000.00	International Finance Corp Note 1.125% Due 7/20/2021	99.208	1.58%	213,297.20	544.70	213,841.90	4,410.81
Sale	10/11/2019	45950VLH7	225,000.00	International Finance Corp Note 2% Due 10/24/2022	101.377	1.53%	228,098.25	2,087.50	230,185.75	4,110.06
Sale	10/11/2019	68389XBK0	115,000.00	Oracle Corp Callable Note Cont 8/15/2021 1.9% Due 9/15/2021	100.313	1.73%	115,359.95	157.81	115,517.76	1,398.43
Sale	10/11/2019	747525AD5	120,000.00	Qualcomm Inc Note 2.25% Due 5/20/2020	100.182	1.95%	120,218.40	1,057.50	121,275.90	382.31
Sale	10/22/2019	31846V203	6,377.44	First American Govt Obligation Fund Class Y	1.000	1.57%	6,377.44	0.00	6,377.44	0.00
Sale	10/22/2019	912828P87	100,000.00	US Treasury Note 1.125% Due 2/28/2021	99.320	1.63%	99,320.31	160.71	99,481.02	275.57
<b>Subtotal</b>			<b>5,371,377.44</b>				<b>5,445,669.27</b>	<b>25,663.71</b>	<b>5,471,332.98</b>	<b>84,593.36</b>
Paydown	10/15/2019	47788BAD6	1,250.26	John Deere Owner Trust 2017-B A3 1.82% Due 10/15/2021	100.000		1,250.26	19.84	1,270.10	0.00
Paydown	10/15/2019	47788CAC6	0.00	John Deere Owner Trust 2018-A A3 2.66% Due 4/18/2022	100.000		0.00	77.58	77.58	0.00
Paydown	10/15/2019	47788EAC2	0.00	John Deere Owner Trust 2018-B A3 3.08% Due 11/15/2022	100.000		0.00	256.67	256.67	0.00
Paydown	10/15/2019	65479GAD1	0.00	Nissan Auto Receivables Trust 2018-B A3 3.06% Due 3/15/2023	100.000		0.00	204.00	204.00	0.00
Paydown	10/15/2019	89238BAB8	7,877.16	Toyota Auto Receivables Trust 2018-A A2A 2.1% Due 10/15/2020	100.000		7,877.16	28.93	7,906.09	0.00
Paydown	10/18/2019	43814UAG4	0.00	Honda Auto Receivables Trust 2018-2 A3 3.01% Due 5/18/2022	100.000		0.00	100.33	100.33	0.00
<b>Subtotal</b>			<b>9,127.42</b>				<b>9,127.42</b>	<b>687.35</b>	<b>9,814.77</b>	<b>0.00</b>

Transaction Type	Settlement Date	CUSIP	Quantity	Security Description	Price	Acq/Disp Yield	Amount	Interest Pur/Sold	Total Amount	Gain/Loss
<b>DISPOSITIONS</b>										
Security Withdrawal	10/03/2019	31846V203	1,023.34	First American Govt Obligation Fund Class Y	1.000		1,023.34	0.00	1,023.34	0.00
Security Withdrawal	10/15/2019	31846V203	5,560,000.00	First American Govt Obligation Fund Class Y	1.000		5,560,000.00	0.00	5,560,000.00	0.00
Security Withdrawal	10/24/2019	31846V203	104.17	First American Govt Obligation Fund Class Y	1.000		104.17	0.00	104.17	0.00
<b>Subtotal</b>			<b>5,561,127.51</b>				<b>5,561,127.51</b>	<b>0.00</b>	<b>5,561,127.51</b>	<b>0.00</b>
<b>TOTAL DISPOSITIONS</b>			<b>10,941,632.37</b>				<b>11,015,924.20</b>	<b>26,351.06</b>	<b>11,042,275.26</b>	<b>84,593.36</b>
<b>OTHER TRANSACTIONS</b>										
Interest	10/05/2019	3135G0T45	200,000.00	FNMA Note 1.875% Due 4/5/2022	0.000		1,875.00	0.00	1,875.00	0.00
Interest	10/07/2019	3135G0Q89	160,000.00	FNMA Note 1.375% Due 10/7/2021	0.000		1,100.00	0.00	1,100.00	0.00
Interest	10/10/2019	02665WCQ2	135,000.00	American Honda Finance Note 3.625% Due 10/10/2023	0.000		2,446.88	0.00	2,446.88	0.00
<b>Subtotal</b>			<b>495,000.00</b>				<b>5,421.88</b>	<b>0.00</b>	<b>5,421.88</b>	<b>0.00</b>
Dividend	10/01/2019	31846V203	190,044.95	First American Govt Obligation Fund Class Y	0.000		179.14	0.00	179.14	0.00
<b>Subtotal</b>			<b>190,044.95</b>				<b>179.14</b>	<b>0.00</b>	<b>179.14</b>	<b>0.00</b>
<b>TOTAL OTHER TRANSACTIONS</b>			<b>685,044.95</b>				<b>5,601.02</b>	<b>0.00</b>	<b>5,601.02</b>	<b>0.00</b>

Chandler Asset Management, Inc. ("Chandler") is an SEC registered investment adviser. For additional information about our firm, please see our current disclosures (Form ADV). To obtain a copy of our current disclosures, you may contact your client service representative by calling the number on the front of this statement or you may visit our website at [www.chandlerasset.com](http://www.chandlerasset.com).

Information contained in this monthly statement is confidential and is provided for informational purposes only and should not be construed as specific investment or legal advice. The information contained herein was obtained from sources believed to be reliable as of the date of this statement, but may become outdated or superseded at any time without notice.

**Custody:** Your qualified custodian bank maintains control of all assets reflected in this statement and we urge you to compare this statement to the one you receive from your qualified custodian. Chandler does not have any authority to withdraw or deposit funds from/to the custodian account.

**Valuation:** Prices are provided by IDC, an independent pricing source. In the event IDC does not provide a price or if the price provided is not reflective of fair market value, Chandler will obtain pricing from an alternative approved third party pricing source in accordance with our written valuation policy and procedures. Our valuation procedures are also disclosed in Item 5 of our Form ADV Part 2A.

**Performance:** Performance results are presented gross-of-advisory fees and represent the client's Total Return. The deduction of advisory fees lowers performance results. These results include the reinvestment of dividends and other earnings. Past performance may not be indicative of future results. Therefore, clients should not assume that future performance of any specific investment or investment strategy will be profitable or equal to past performance levels. All investment strategies have the potential for profit or loss. Economic factors, market conditions or changes in investment strategies, contributions or withdrawals may materially alter the performance and results of your portfolio.

Source ice Data Indices, LLC ("ICE"), used with permission. ICE PERMITS USE OF THE ICE INDICES AND RELATED DATA ON AN "AS IS" BASIS; ICE, ITS AFFILIATES AND THEIR RESPECTIVE THIRD PARTY SUPPLIERS DISCLAIM ANY AND ALL WARRANTIES AND REPRESENTATIONS, EXPRESS AND/OR IMPLIED, INCLUDING ANY WARRANTIES OF MERCHANTABILITY OR FITNESS FOR A PARTICULAR PURPOSE OR USE, INCLUDING THE INDICES, INDEX DATA AND ANY DATA INCLUDED IN, RELATED TO, OR DERIVED THEREFROM. NEITHER ICE DATA, ITS AFFILIATES OR THEIR RESPECTIVE THIRD PARTY PROVIDERS GUARANTEE THE QUALITY, ADEQUACY, ACCURACY, TIMELINESS OR COMPLETENESS OF THE INDICES OR THE INDEX DATA OR ANY COMPONENT THEREOF, AND THE INDICES AND INDEX DATA AND ALL COMPONENTS THEREOF ARE PROVIDED ON AN "AS IS" BASIS AND LICENSEE'S USE IS AT LICENSEE'S OWN RISK. ICE DATA, ITS AFFILIATES AND THEIR RESPECTIVE THIRD PARTY DO NOT SPONSOR, ENDORSE, OR RECOMMEND CHANDLER, OR ANY OF ITS PRODUCTS OR SERVICES.

Index returns assume reinvestment of all distributions. Historical performance results for investment indexes generally do not reflect the deduction of transaction and/or custodial charges or the deduction of an investment management fee, the incurrence of which would have the effect of decreasing historical performance results. It is not possible to invest directly in an index.

**Ratings:** Ratings information have been provided by Moody's, S&P and Fitch through data feeds we believe to be reliable as of the date of this statement, however we cannot guarantee its accuracy.

Security level ratings for U.S. Agency issued mortgage-backed securities ("MBS") reflect the issuer rating because the securities themselves are not rated. The issuing U.S. Agency guarantees the full and timely payment of both principal and interest and carries a AA+/Aaa/AAA by S&P, Moody's and Fitch respectively.

Benchmark Index	Disclosure
ICE BAML 1-5 Yr US Treasury/Agency Index	The ICE BAML 1-5 Year US Treasury & Agency Index tracks the performance of US dollar denominated US Treasury and nonsubordinated US agency debt issued in the US domestic market. Qualifying securities must have an investment grade rating (based on an average of Moody's, S&P and Fitch). Qualifying securities must have at least one year remaining term to final maturity and less than five years remaining term to final maturity, at least 18 months to maturity at time of issuance, a fixed coupon schedule and a minimum amount outstanding of \$1 billion for sovereigns and \$250 million for agencies. (Index: GVA0. Please visit <a href="http://www.mlindex.ml.com">www.mlindex.ml.com</a> for more information)





**Board of Directors  
Staff Report**

**To:** TVMWD Board of Directors  
**From:** Matthew H. Litchfield, General Manager   
**Date:** November 20, 2019  
**Subject:** YTD District Budget Status Report

---

<input type="checkbox"/> For Action	<input type="checkbox"/> Fiscal Impact	\$
<input checked="" type="checkbox"/> Information Only	<input type="checkbox"/> Funds Budgeted:	

---

**Staff Recommendation:**

**No Action Necessary – Informational Item Only**

**Discussion:**

Attached for your review is the YTD District Budget Status Report for the period ending October 31, 2019.

Revenues for the **MWD RTS Standby Charge** and **Property Taxes** will remain low until the first round of property tax payments are received in December.

The **Grants and Other Revenue** line item reflects funds received in the amount of \$197,628 for the Cadiz Water Project Peer Review and \$72,000 for Termination and Release of the 1984 Grant of Easement for the 901 Corporate Center Drive, Pomona, property.

The first of two payments for the **MWD RTS Charge** and the **MWD Capacity Charge** were billed by MWD this month. The remaining payments will be due in April 2020.

The **Planning & Resources** line item is 114.7% of budget due to an \$82,000 payment made to Metropolitan Water District for work performed related to two new service connections, San Dimas Wash and Thompson Creek.

Due to the payment schedule for **Membership Dues & Fees**, the YTD actuals are higher than expected. This line item may exceed budget slightly as a result of LAFCO fees increasing more than was planned.

**Strategic Plan Objective(s):**

3.1 – Utilize and comply with a set of financial policies to maintain TVMWD’s financial health

**Attachment(s):**

Exhibit A – YTD District Budget Status Report

**Meeting History:**

None

NA/LC

THREE VALLEYS MUNICIPAL WATER DISTRICT				
DISTRICT BUDGET - FISCAL YEAR 2019-2020				
Month Ending October 31, 2019				
	2019-2020 YTD Actual	Annual Budget All Funds	2019-2020 Percent of Budget	2019-2020 Balance Remaining
<b>REVENUES</b>				
<b>OPERATING REVENUES</b>				
Water Sales	26,490,553	58,985,405	44.9%	32,494,852
MWD RTS Standby Charge	26,194	3,551,583	0.7%	3,525,389
MWD Capacity Charge Assessment	362,347	1,173,600	30.9%	811,253
TVMWD Fixed Charges	227,106	685,623	33.1%	458,517
Hydroelectric Revenue	7,048	126,609	5.6%	119,561
<b>NON-OPERATING REVENUES</b>				
Property Taxes	73,118	2,300,944	3.2%	2,227,826
Interest Income	160,042	212,900	75.2%	52,858
Pumpback O&M/Reservoir #2 Reimbursement	-	20,000	0.0%	20,000
Grants and Other Revenue	280,507	5,170	5425.7%	(275,337)
<b>TOTAL REVENUES</b>	<b>27,626,915</b>	<b>67,061,834</b>	<b>41.2%</b>	<b>39,434,919</b>
<b>EXPENSES</b>				
<b>OPERATING EXPENSES</b>				
MWD Water Purchases	25,368,831	52,837,522	48.0%	27,468,691
MWD RTS Standby Charge	1,672,486	3,551,583	47.1%	1,879,097
Staff Compensation	1,499,234	4,200,756	35.7%	2,701,522
MWD Capacity Charge	543,520	1,173,600	46.3%	630,080
Operations and Maintenance	636,034	1,383,532	46.0%	747,498
Professional Services	259,265	524,982	49.4%	265,717
Directors Compensation	80,035	331,520	24.1%	251,485
Communication and Conservation Programs	61,664	193,000	32.0%	131,336
Planning & Resources	103,204	90,000	114.7%	(13,204)
Membership Dues and Fees	64,295	81,054	79.3%	16,759
Hydroelectric Facilities	1,520	39,000	3.9%	37,480
Board Elections	-	-	0.0%	-
<b>NON OPERATING EXPENSES</b>				
Pumpback O&M/Reservoir #2 Expenses	664	20,000	3.3%	19,336
<b>RESERVE EXPENSES</b>				
Reserve Replenishment	-	238,181	0.0%	238,181
<b>CAPITAL INVESTMENT</b>				
Capital Repair & Replacement	74,307	734,297	10.1%	659,990
Capital Investment Program	2,499,224	5,024,508	49.7%	2,525,284
<b>TOTAL EXPENSES</b>	<b>32,864,283</b>	<b>70,423,535</b>	<b>46.7%</b>	<b>37,559,252</b>
<b>NET INCOME (LOSS) BEFORE TRANSFERS</b>		<b>(3,361,701)</b>		
TRANSFER FROM/(TO) CAPITAL RESERVES		1,217,269		
TRANSFER IN FROM BOARD ELECTION RESERVES		-		
TRANSFER IN FROM ENCUMBERED RESERVES		2,276,692		
<b>NET INCOME (LOSS) AFTER TRANSFERS</b>		<b>\$ 132,260</b>		

**\*\*This budget is prepared on a modified cash-basis of accounting, which is a basis of accounting other than generally accepted accounting principles (GAAP).**



**Board of Directors  
Staff Report**

**To:** TVMWD Board of Directors  
**From:** Matthew H. Litchfield, General Manager   
**Date:** November 20, 2019  
**Subject:** **Warrant List**

---

<input checked="" type="checkbox"/> <b>For Action</b>	<input checked="" type="checkbox"/> <b>Fiscal Impact</b>	<b>\$ 8,399,486.15</b>
<input type="checkbox"/> <b>Information Only</b>	<input type="checkbox"/> <b>Funds Budgeted:</b>	

---

**Staff Recommendation:**

**Receive and file the Warrant List for the period ending October 31, 2019 as presented.**

**Discussion:**

The monthly warrant list is provided for your information.  
 General checks 49821 through 49930 totaling \$1,396,452.92 are listed on pages 1 to 5.  
 MWD August water invoice totaling \$6,755,606.50 is listed on page 5.  
 Wire transfers for taxing agencies, benefit payments and PERS totaling \$87,212.10 are listed on pages 5 to 6.  
 Total payroll checks 12887 through 12941 totaling \$160,214.63 are listed on page 6.  
 Umpqua Bank invoices details are listed on pages 7 to 8.

**Strategic Plan Objective(s):**

3.1 – Utilize and comply with a set of financial policies to maintain TVMWD’s financial health

**Attachment(s):**

Exhibit A – Warrant List

**Meeting History:**

None  
 NA/LC



THREE VALLEYS MUNICIPAL WATER DISTRICT

Warrant List

October 2019

General Checks 49821 through 49930

Payroll Wire Transfer 2784 through 2797

Payroll Checks 12887 through 12941

Item 10.B

Check Number	Vendor	Description	Paid Amount
49821	DE LAGE LANDEN FIN SVCS, INC.	POSTAGE METER LEASING CHARGES 9/15/19 - 10/14/19	114.85
49822	EUROFINS EATON ANALYTICAL	LABORATORY TESTING - TOC	60.00
49823	GRISWOLD INDUSTRIES	JWL CONTROL VALVE - SOLENOIDS AND Y STRAINER INSTALL	806.00
49824	HACH COMPANY	TURBIDITY SENSORS PREVENTATIVE MAINTENANCE	11,343.30
49825	HARRINGTON IND PLASTICS, LLC	BUSHINGS/VALVE BALL/UNIONS	956.17
49826	HOWIE, KIRK	MILEAGE EXPENSE AUG/SEPT	55.68
49827	IDEAL COMFORT CORP.	HEAT & AIR CONDITIONING ELECTRICAL COMPONENTS/CONNECTIONS FOR NEW OFFICE	135.00
49828	JAN-PRO CLEANING SYST	JANITORIAL SERVICE - OCT	654.00
49829	JERICO SYSTEMS, INC.	MIRAGRAND WELL CA ENVIRONMENTAL QUALITY ACT CLEARANCE JUN - AUG	34,421.50
49830	KELLETT, TIMOTHY	MILEAGE/MEETING EXPENSES - SEPT	110.76
49831	MC MASTER-CARR SUPPLY COMPANY	V-BELT FOR BRIDGE	348.85
49832	RC'S FLOOR & CARPET CARE	BUFF FLOORS	250.00
49833	ROWLAND WATER DISTRICT	10/1 PWAG TRAINING-GM,COHN,ENSIGN,HARBERSON,HOWIE,KELLETT,LANG,LINTHICUM,ROMERO	950.00
49834	SOUTHERN CALIFORNIA EDISON	MIRAMAR - SEPT	61.08
49835	THE FLINTRIDGE CENTER	SILVER SPONSORSHIP - 41ST ASSEMBLY DISTRICT YOUNG LEGISLATORS PROGRAM	2,000.00
49836	BBVA COMPASS	OIL/FILTER/COOLING SYSTEM/TRANSMISSION FLUID/STARTER INSPECTION FOR VEHICLES	839.20
49837	C & E LUMBER COMPANY	NAILS/REDI-MIX CONCRETE/CHAMFER STRIPS FOR EYEWASH STATION	24.75
49838	CELL BUSINESS EQUIPMENT	PLOTTER LEASE - OCT	268.27
49839	HACH COMPANY	MONOCHLORAMINE ASSY PACK/PH STANDARD	360.88
49840	SOUTH COAST MEDIA SVC	OUTREACH AD	564.00
49841	SOUTHERN CALIFORNIA EDISON	MIRAMAR/WILLIAMS/FULTON/PM-26/SCADA/PUMPBACK - SEPT	1,151.91
49842	ACWA	2019 REGION 8 LEGISLATIVE FORUM - MENDOZA	55.00
49843	ACWA/JPIA	AUTO & GENERAL LIABILITY PROGRAM - 10/1/19 - 10/1/20	72,493.00
49844	BRENNTAG PACIFIC, INC.	SODIUM HYDROXIDE	7,513.97



THREE VALLEYS MUNICIPAL WATER DISTRICT

Warrant List

October 2019

General Checks 49821 through 49930

Payroll Wire Transfer 2784 through 2797

Payroll Checks 12887 through 12941

Item 10.B

Check Number	Vendor	Description	Paid Amount
49845	CA DEPT OF TAX & FEE ADMIN	2019 USE TAX QUARTER 3	189.00
49846	CLS LANDSCAPE MANAGEMENT	BROKEN SPRINKLERS/VALVE BOX REPLACED	353.77
49847	EUROFINS EATON ANALYTICAL	LABORATORY TESTING - TOC	60.00
49848	GFOA	CAFR AWARD FEE FY 2019	560.00
49849	GOURMET GOURMET CATERING, INC	11/19/19 MEETING EXPENSE DEPOSIT	500.00
49850	GUTIERREZ, JOSEPH	MIRAGRAND WELL PRELIMINARY DESIGN REPORT	3,390.43
49851	HARRINGTON IND PLASTICS, LLC	ELBOWS	129.95
49852	IDEAL COMFORT CORP.	A/C CAPACITOR REPLACED/SUCTION LINE INSULATION INSTALL	277.00
49853	JCI JONES CHEMICALS, INC.	CHLORINE	5,452.31
49854	LARRY BURKE ENTERPRISES	BATTERY/CORE FOR FORKLIFT	140.11
49855	LINCOLN FINANCIAL GROUP	401A DEFRD: OCTOBER 6 PAYROLL	600.00
49856	LINCOLN LIFE, EMPL SVCS(5H-26)	457 DEFRD: OCTOBER 6 PAYROLL	9,005.00
49857	MC MASTER-CARR SUPPLY COMPANY	STUD ANCHORS/GROMMETS/SCREW STARTER/HOLE SAW/MINIATURE LIGHT BULBS	702.14
49858	OFFICE DEPOT	MULTIFOLD PAPER TOWELS/BATHROOM TISSUE PAPER/ CARTRIDGE INK/PAPER	309.20
49859	PHINNEY, DENNIS JAY	TVMWD STANDARD TECHNICAL SPECIFICATIONS DEVELOPMENT & PREPARATION SERVICES	2,400.00
49860	POLYDYNE, INC	CLARIFLOC	893.75
49861	QUALITY HOIST & ELECTRIC	GROUNDING BARS/HARDWARE FOR MONORAILS FURNISH/INSTALL AT CHLORINE BLDG	3,126.40
49862	ROBERT AVERY CARTER	DOOR LOCKS/REKEY PADLOCKS	297.19
49863	SAM'S CLUB	SWP TOUR SUPPLIES	203.21
49864	SOUTHERN CALIFORNIA EDISON	MIRAMAR/WILLIAMS/FULTON - SEPT	21,311.68
49865	THOMPSON PLUMBING SUPPLY	SHOWER AND EYE/FACE WASH COMBINATION STATION	1,323.26
49866	UNIVAR USA INC	LIQUID CHLORINE	1,984.98
49867	WEST COAST ARBORISTS, INC.	LANDSCAPE MAINT-TREE SPRAY INSECTICIDE/TRUNK INJECTION FUNGICIDE/INSECTICIDE	1,600.00
49868	WEX BANK	FUEL 9/1/19 - 9/30/19	1,397.00



THREE VALLEYS MUNICIPAL WATER DISTRICT

Warrant List

October 2019

General Checks 49821 through 49930

Payroll Wire Transfer 2784 through 2797

Payroll Checks 12887 through 12941

Item 10.B

Check Number	Vendor	Description	Paid Amount
49869	CAPITOL ENQUIRY	2020 STAFF INDEX/POCKET DIRECTORIES OF CA LEGISLATIVE/PROFILE EDITION	775.51
49870	LARSON, JONATHAN	D3 EXAM & CERTIFICATION	190.00
49871	LINCOLN CLUBS	10/24/19 SGV CHAPTER MEETING - RUZICKA	35.00
49872	LSL CPAS	2019 GOVERNMENT AUDIT - FINAL	2,326.00
49873	UMPQUA BANK	UMPQUA BANK INVOICE DETAIL - LAST PAGE	21,435.25
49874	UMPQUA BANK	UMPQUA BANK INVOICE DETAIL - LAST PAGE	6,372.67
49875	KEMIRA WATER SOLUTIONS, INC.	PAX-XL19	16,933.50
49876	LOWE'S	NUTS/DRILLS/CABLE TIES/VALVES/CONCRETE/TOWELS/OUTLETS/MISC SUPPLIES	908.37
49877	SAN GABRIEL VALLEY MWD	WATER DELIVERY TO NORTH AZUSA CONNECTION	9,440.00
49878	PRES-TECH, PRES-TECH EQUIP CO	HYDRO EXCAVATOR/VALVE TURNING TRAILER	124,672.85
49879	ACWA/JPIA	ACWA EMPLOYEE BENEFITS - NOVEMBER 2019	49,392.90
49880	ACWA/JPIA	WORKER'S COMPENSATION 7/01/19 - 9/30/19	11,707.67
49881	AMS PAVING INC.	CONCRETE STEPS AND PAVEMENT EXPANSION	35,354.00
49882	BRUNICK, MCELHANEY & KENNEDY	LEGAL FEES - SEPT	15,040.00
49883	CANON FINANCIAL SERVICES, INC.	COPY MACHINE LEASE - OCT	1,755.56
49884	CDW GOVERNMENT LLC	MS SURFACE PROS	5,221.73
49885	CITY OF CLAREMONT	REFUSE PICKUP/STREET SWEEPING - SEPT	153.67
49886	CLS LANDSCAPE MANAGEMENT	LANDSCAPE MAINTENANCE - OCT	2,965.00
49887	DENALI WATER SOLUTIONS, LLC	SLUDGE REMOVAL - SEPT	3,932.39
49888	E.J. MEYER COMPANY, INC.	GRAND AVE WELL EQUIPPING/BUILDING/PIPELINE/PRESSURETEST/SCE CONDUIT INSTALLATION	619,380.00
49889	JERICHO SYSTEMS, INC.	MIRAGRAND WELL CA ENVIRONMENTAL QUALITY ACT CLEARANCE - JUN	10,073.50
49890	LAGERLOF,SENECAL,GOSNEY & KRUSE LLP	LEGAL FEES THROUGH SEPT 27, 2019	1,024.10
49891	LINCO	LARGE FRAME WITH MULTIPLE OPENINGS	755.55
49892	LINCOLN FINANCIAL GROUP	401A DEFERRED: OCTOBER 20 PAYROLL	600.00



THREE VALLEYS MUNICIPAL WATER DISTRICT

Warrant List

October 2019

General Checks 49821 through 49930

Payroll Wire Transfer 2784 through 2797

Payroll Checks 12887 through 12941

Item 10.B

Check Number	Vendor	Description	Paid Amount
49893	LINCOLN LIFE, EMPL SVCS(5H-26)	457 DEFRD: BOARD-OCTOBER 2019	5,111.00
49894	LINCOLN LIFE, EMPL SVCS(5H-26)	457 DEFRD: OCTOBER 20 PAYROLL	9,005.00
49895	METROPOLITAN WATER DISTRICT	NEW SERVICE CONNECTIONS AT SAN DIMAS WASH AND THOMPSON CREEK	82,000.00
49896	MICHAEL J ARNOLD & ASSOC, INC.	LEGISLATIVE CONSULTANT OCT/SEPT EXPENSES	6,084.00
49897	OFFICE DEPOT	CORRECTION TAPE/MONTHLY DESK CALENDAR/POST-IT NOTES/INVISIBLE TAPE	103.49
49898	PACIFIC PREMIER BANK	GRAND AVE WELL EQUIPPING RETENTION - SEPT	32,598.95
49899	PEST OPTIONS INC.	ANT REMOVAL	195.00
49900	POLYDYNE, INC	CLARIFLOC	2,737.69
49901	REDI-RELIEF FIRST AID & SAFETY, INC.	FIRST AID KITS/IBUPROFEN/ASPIRIN/LENS CLEANING TOWELETTES/COUGH DROPS/BURN SPRAY	120.80
49902	SCHEEVEL ENGINEERING	DRY CHEM BUILDING MODIFICATIONS - SEPT	4,600.00
49903	SMITH-EMERY LABORATORIES	GRAND AVE WELL EQUIPPING PROJECT - FIELD TESTING	4,320.00
49904	TRANSPORTATION CONNECTION INC.	11/1/19 CTEC FIELD TRIP TO ORANGE COUNTY WATER TREATMENT PLANT TRANSPORTATION	823.00
49905	WEST COAST ARBORISTS, INC.	TREE PRUNING	10,800.00
49906	INTERFACE SECURITY SYSTEMS LLC	EOC WIRELESS BROADBAND SERVICE 11/1/19 - 11/30/19	134.88
49907	PIKE, THOMAS M.	RANCHO SANTA ANA BOTANICAL GARDEN APPRAISAL & REPORT	3,500.00
49908	SOCALGAS	FULTON SERVICE 09/04/19 - 10/03/19	14.30
49909	AFLAC	AFLAC SUPP. INS: OCTOBER 2019 (EMPLOYEE REIMBURSED)	1,074.06
49910	CALIFORNIA PARTY RENT	SOLAR CUP 2020 BOAT BLDG WORKSHOP-TENTS/TABLES/CHAIRS RENTAL(REIMBURSED BY MWD)	11,675.00
49911	HACH COMPANY	TOTAL/FREE AMMONIA ASSY PACKS/MONOCHLORAMINE ASSY PACK/AMMONIA/MONOCHLORAMINE	2,756.72
49912	JCI JONES CHEMICALS, INC.	CHLORINE	5,452.31
49913	KEMIRA WATER SOLUTIONS, INC.	PAX-XL19	16,557.20
49914	LOS ANGELES TIMES	NEWSPAPER SUBSCRIPTION THROUGH 2/11/20	136.50
49915	RELIANCE STANDARD LIFE INS.	ST/LT DISAB: OCTOBER 2019	960.34
49916	SYNCB/AMAZON	CALIBRATION GAS/UPS BATTERY BACKUP/COMPUTER SUPPLIES/KEURIG BREWING SYSTEM	1,294.33





THREE VALLEYS MUNICIPAL WATER DISTRICT

Warrant List

October 2019

General Checks 49821 through 49930

Payroll Wire Transfer 2784 through 2797

Payroll Checks 12887 through 12941

Item 10.B

Check Number	Vendor	Description	Paid Amount
49917	THOMAS HARDER & CO.	GRAND AVE WELL-ENGR DESIGN/ANALYSIS/CONSTRUCTION MGMT/INSPECTION	45,660.50
49918	AAA PORTABLE RESTROOM CO.	SOLAR CUP 2020 BOAT BLDG WORKSHOP RESTROOMS/WASH STATIONS (REIMBURSED BY MWD)	1,180.00
49919	CLAREMONT PRINT & COPY	GRID SHEETS	161.70
49920	COHN, ELIZABETH M.	MILEAGE EXPENSE - WALNUT VALLEY WD INTERVIEW PANEL	11.37
49921	INLAND EMPIRE UTILITIES AGENCY	10/31/19 LEADERSHIP BREAKFAST CANCELLATION REFUND	20.00
49922	KELLETT, TIMOTHY	MILEAGE/MEETING EXPENSES - OCT	66.01
49923	LAGERLOF,SENECAL,GOSNEY & KRUSE LLP	LEGAL FEES THROUGH SEPT 30, 2019	118.53
49924	LARRY BURKE ENTERPRISES	BATTERY FOR WILLIAMS HYDRO CAMERA	29.55
49925	MC MASTER-CARR SUPPLY COMPANY	MARKING FLAGS/FLUKE TEST LEAD KIT/FUSES/WASHERS/HOLE PLUGS	152.57
49926	JAN-PRO CLEANING SYST	JANITORIAL SERVICE - NOV	661.00
49927	POMONA WHOLESALE ELECTRIC	BUILDING WIRE FOR EOC	533.40
49928	RED WING BUSINESS ADVNTGE ACCT	SAFETY FOOTWEAR - COLE/ENSIGN	400.00
49929	SOUTHERN CALIFORNIA EDISON	GRAND AVE - LINE EXTENSION TO FEED WELL/PUMP	8,634.29
49930	WATER SHARK SYSTEMS LLC	LAB WASTE DISPOSAL	4,579.66
<b>TOTAL AMOUNT OF CHECKS LISTED</b>			<b>\$ 1,396,452.92</b>
12795	METROPOLITAN WATER DISTRICT	AUGUST 2019 MWD WATER INVOICE	6,755,606.50
<b>TOTAL AMOUNT OF WIRE TRANSFERS</b>			<b>\$ 6,755,606.50</b>
2784	FEDERAL TAX PAYMENT	FED TAX: OCTOBER 6 PAYROLL	14,617.00
2785	BASIC PACIFIC	HEALTH SAVINGS ACCT: OCTOBER 6 PAYROLL	1,027.50
2786	PUBLIC EMPLOYEES RETIREMENT SY	PERS CONTR: OCTOBER 6 PAYROLL	17,648.80
2787	STATE TAX PAYMENT	STATE TAX: OCTOBER 6 PAYROLL	5,227.75



THREE VALLEYS MUNICIPAL WATER DISTRICT

Warrant List

October 2019

General Checks 49821 through 49930

Payroll Wire Transfer 2784 through 2797

Payroll Checks 12887 through 12941

Item 10.B

Check Number	Vendor	Description	Paid Amount
2788	CALPERS-457 PLAN	PERS-457 DEFERRED COMP/EMPL LOAN: OCTOBER 6 PAYROLL	3,879.37
2789	FEDERAL TAX PAYMENT	FED TAX: BOARD-OCTOBER 2019	1,316.03
2790	BASIC PACIFIC	HEALTH SAVINGS ACCT: BOARD-OCTOBER 2019	516.66
2791	STATE TAX PAYMENT	STATE TAX: BOARD-OCTOBER 2019	535.72
2792	CALPERS-457 PLAN	PERS-457 DEFERD COMP: BOARD-OCTOBER 2019	350.00
2793	FEDERAL TAX PAYMENT	FED TAX: OCTOBER 20 PAYROLL	14,663.96
2794	BASIC PACIFIC	HEALTH SAVINGS ACCT: OCTOBER 20 PAYROLL	1,027.50
2795	PUBLIC EMPLOYEES RETIREMENT SY	PERS CONTR: OCTOBER 20 PAYROLL	17,634.48
2796	STATE TAX PAYMENT	STATE TAX: OCTOBER 20 PAYROLL	5,187.33
2797	CALPERS-457 PLAN	PERS-457 DEFERRED COMP: OCTOBER 20 PAYROLL	3,580.00
<b>TOTAL AMOUNT OF PAYROLL WIRE TRANSFERS LISTED</b>			<b>\$ 87,212.10</b>

**PAYROLL SUMMARY**

Check# 12887 - 12941

**TOTAL AMOUNT OF PAYROLL CHECKS LISTED \$ 160,214.63**

**TOTAL OCTOBER 2019 CASH DISBURSEMENTS \$ 8,399,486.15**



THREE VALLEYS MUNICIPAL WATER DISTRICT  
Warrant List  
October 2019  
Umpqua Bank E-Payables Invoice Detail Check 49873  
Umpqua Bank Credit Cards Invoice Detail Check 49874

Item 10.B

Check Number	Vendor	Description	Paid Amount
49873	ACCENT COMPUTER SOLUTIONS, INC.	IT SERVICES - SEPT/SERVER WARRANTY RENEWAL/VISIO ONLINE PLAN/MICROSOFT SUPPORT	6,222.32
49873	AIRGAS SPECIALTY PRODUCTS	AMMONIA	5,580.75
49873	AIRGAS USA, LLC	OXYGEN CYLINDER RENTAL	55.64
49873	ALS GROUP USA, CORP	LABORATORY TESTING FOR THM	250.00
49873	AZUSA LIGHT & WATER	ELECTRIC UTILITY 7/08/19 TO 8/08/19	19.49
49873	CONSOLIDATED ELECTRICAL	WIRE FOR BASIN A/AMMONIA DISINFECTION SUPPLIES/CAPS/RELAY CABLES/ANCHORS/PRINTER KIT	1,081.53
49873	FIREMASTER	EXTINGUISHERS ANNUAL MAINTENANCE & TRAINING	1,540.66
49873	FRANCOTYP-POSTALIA, INC.	POSTAGE METER RENTAL 8/08/19 - 11/07/19	111.69
49873	FRONTIER	DSL FOR SCADA 8/10/19 - 9/09/19	95.98
49873	GROUND CONTROL SYSTEMS, INC.	IDIRECT EMERGENCY RESPONDER SERVICES FEE - SEPT	279.00
49873	R & S OVERHEAD DOORS OF INLAND	GATE MAINTENANCE AT FULTON	325.00
49873	SAN ANTONIO WATER COMPANY	WATER AVAILABILITY 6/30/19 TO 8/29/19	4.00
49873	SARTORIUS CORPORATION	CALIBRATION & PREVENTIVE MAINTENANCE/CERTIFICATES OF CALIBRATION	477.00
49873	TELEPACIFIC COMMUNICATIONS	TELEPHONE SERVICE 8/16/19 - 9/15/19	1449.35
49873	THERMO FISHER SCIENTIFIC LLC	SOLENOID VALVE	492.75
49873	TIME WARNER CABLE	BROADBAND SERVICES - WILLIAMS/PLANT 2/FULTON 8/9/19 - 9/20/19	239.97
49873	ULINE	STREET BROOMS	60.47
49873	UPS	SHIPPING CHARGES	23.66
49873	VERIZON WIRELESS	CELLULAR/IPAD/HARNESS FLEET SERVICES/MOBILE BROADBAND/IPADS 8/26/19 - 9/25/19	721.25
49873	VWR INTERNATIONAL INC.	TEST TUBES/BUFFER SOLUTIONS	260.08
49873	WESTERN WATER WORKS SUPPORT	FLEX COUPLINGS/GASKETS/DUCTILE IRON BLADE/VITA-D-DECHLORINATING TABLETS	2,144.66
<b>TOTAL AMOUNT OF UMPQUA BANK E-PAYABLES SERVICES INVOICE</b>			<b>\$ 21,435.25</b>



THREE VALLEYS MUNICIPAL WATER DISTRICT  
 Warrant List  
 October 2019  
 Umpqua Bank E-Payables Invoice Detail Check 49873  
 Umpqua Bank Credit Cards Invoice Detail Check 49874

Item 10.B

Check Number	Vendor	Description	Paid Amount
49874	ACWA	2019 FALL CONFERENCE - KELLETT, LITCHFIELD / 10/10/19 REGION 9 TOUR & PROGRAM - KELLETT	1,185.00
49874	ARCBEST	RETURN FLOW METER FREIGHT CHARGES	526.36
49874	BROWN & CALDWELL	HR MANAGER RECRUITMENT AD	200.00
49874	CONCEPT CONTROLS	CHLORINE GAS	249.94
49874	CSDA	9/25-28/19 CONFERENCE - LITCHFIELD	375.00
49874	CSMFO	9/18/19 SGV CHAPTER MEETING - LINTHICUM	40.00
49874	D & R OFFICE WORKS, INC.	FURNITURE DEPOSIT	1,925.00
49874	JURY GALLEGOS	STAFF PORTRAITS	150.00
49874	HOME DEPOT	ROOF SEALANT FOR EOC	51.59
49874	MISCELLANEOUS VENDORS	EVENTS REGISTRATIONS & EXPENSES - SEPT	202.95
49874	O'REILLY AUTO PARTS	CORE CHARGE RETURN	(10.00)
49874	SCWUA	VENDOR'S FAIR - GOYTIA	32.00
49874	SHADES OF GLASS	WINDOW TINT FOR DISTRICT VEHICLES	480.00
49874	SHRM	HR MANAGER RECRUITMENT AD	395.00
49874	SIBER SYSTEMS	PASSWORD ANNUAL SUBSCRIPTION - ROMERO	23.88
49874	THERMO FISHER SCIENTIFIC LLC	REVERSE OSMOSIS UNIT REPAIR	530.00
49874	WALMART	CARDBOARD BOXES	15.95
<b>TOTAL AMOUNT OF UMPQUA BANK CARD SERVICES INVOICE</b>			<b>\$ 6,372.67</b>



**Tier 1 Balance (in Acre-Feet)  
Calendar Year 2019  
(through October 2019)**

Agency	Tier 1 Allocation					Balance
		Weymouth	Miramar	CIC	Spreading	
Boy Scouts of America	36	17.7	0.0	0.0	0.0	17.9
Cal Poly Pomona	269	90.8	0.0	0.0	0.0	178.2
Covina, City of *	1,568	0.0	0.0	2,731.4	0.0	<b>-1,163.4</b>
Glendora, City of *	4,101	0.0	0.0	0.0	0.0	4,101.3
Golden State Water Company *	15,714	4,766.7	6,969.8	312.4	0.0	3,665.0
La Verne, City of	8,026	0.0	4,144.6	0.0	264.0	3,617.7
Mt San Antonio College	699	356.5	0.0	0.0	0.0	342.5
Pomona, City of *	7,052	2,749.0	503.5	0.0	0.0	3,799.6
Rowland Water District *	14,741	6,263.9	741.6	0.0	0.0	7,735.4
Suburban Water Systems *	1,961	2,967.7	0.0	2,378.9	0.0	<b>-3,385.7</b>
Three Valleys MWD	NA				1,707.0	NA
Valencia Heights Water Co *	464	2.3	0.0	440.6	0.0	21.1
Walnut Valley Water District *	26,057	12,748.2	1,449.0	0.0	0.0	11,859.5

\* Deliveries to JWV are assigned to Pomona, RWD, and WVWD.  
 Deliveries to BGL are assigned to Suburban, VHWC, GSWC and WVWD.  
 Deliveries to CIC are assigned to Covina, Glendora, GSWC, SWS, and VHWC.  
 Quantities apportioned to above agencies are preliminary based on available data.

**TVMWD Tier 1 Allowable = 80,688**  
**MWD Tier 1 Deliveries = 52,089**  
**TVMWD Tier 1 Balance = 28,599**

**Overage by Individual Agencies -4,549.1**

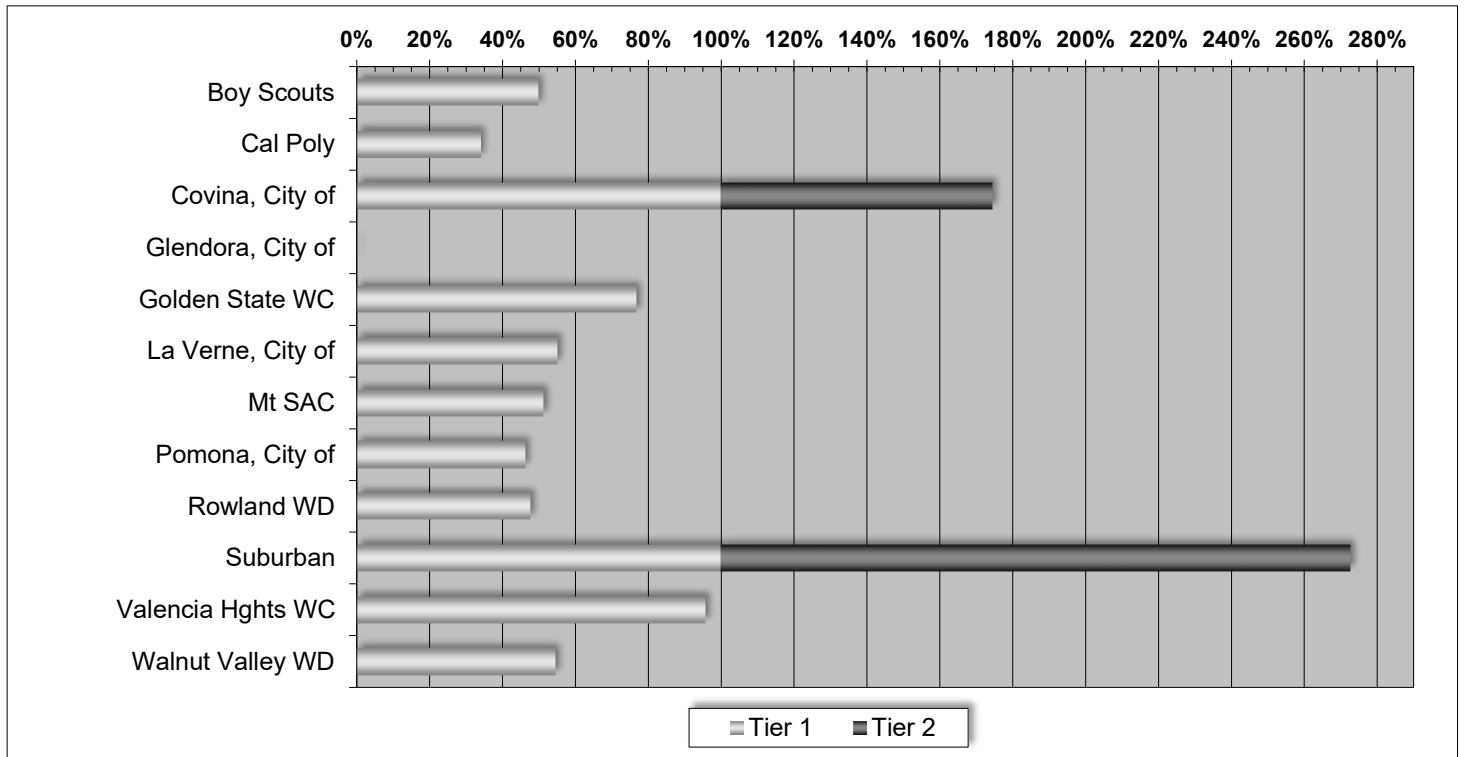

### TVMWD Firm Water Purchases 3-yr Comparison

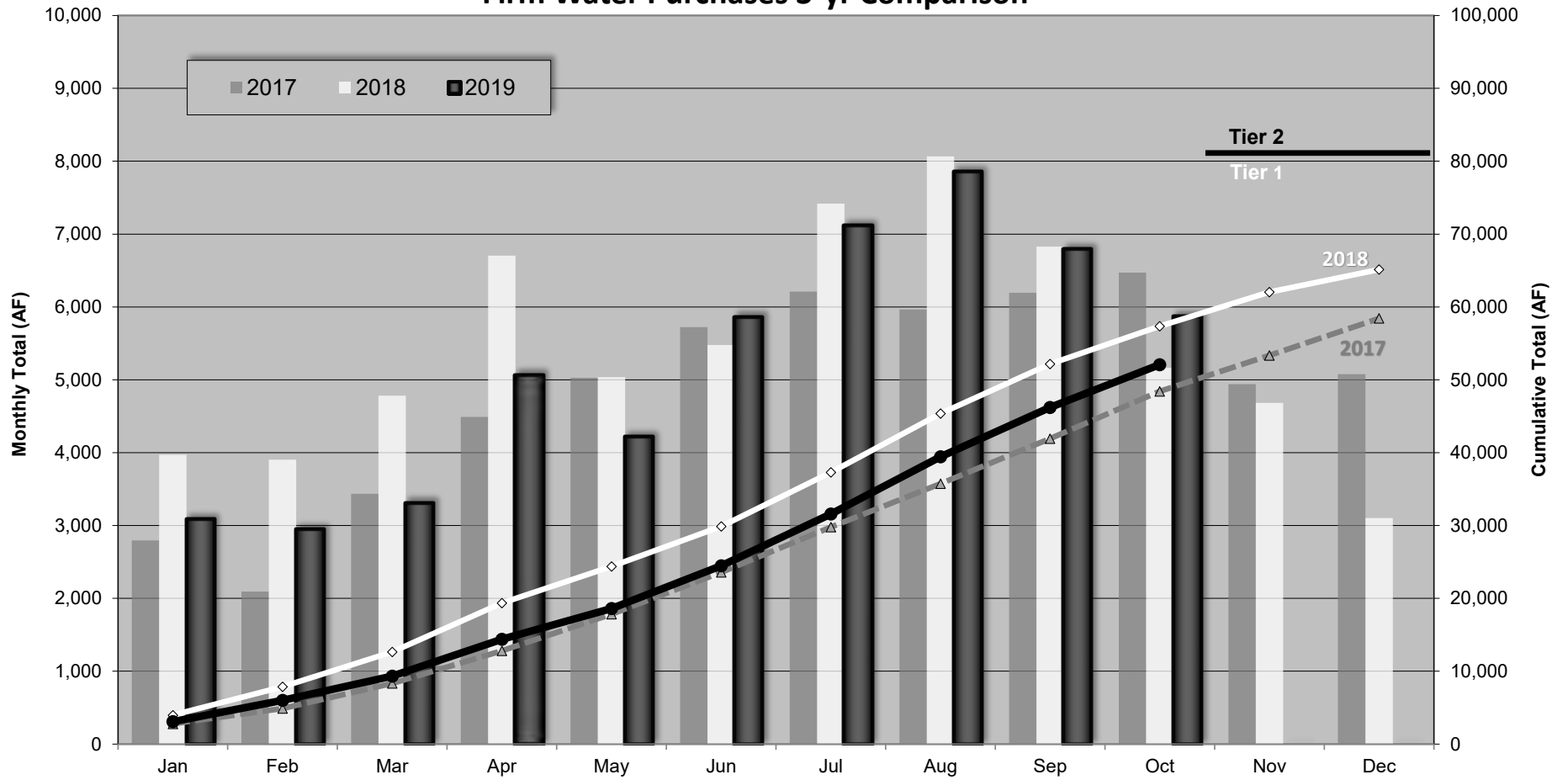

**2019 Firm Water Usage (AF)**

Direct Delivery	3,080.8	2,417.5	3,009.3	4,826.1	4,212.4	5,858.9	7,086.2	7,216.8	6,171.9	5,867.1	0.0	0.0	<b>49,747.0</b>
Spreading Delivery	0.0	528.3	297.0	235.0	1.7	0.0	27.0	634.0	619.0	0.0	0.0	0.0	<b>2,342.0</b>
Total	<b>3,080.8</b>	<b>2,945.8</b>	<b>3,306.3</b>	<b>5,061.1</b>	<b>4,214.1</b>	<b>5,858.9</b>	<b>7,113.2</b>	<b>7,850.8</b>	<b>6,790.9</b>	<b>5,867.1</b>	<b>0.0</b>	<b>0.0</b>	<b>52,088.9</b>

**Three Valleys Municipal Water District  
Miramar Operations Report**

**OCTOBER 2019**

**Water Quality**

The treatment plant produced treated water that met or exceeded state and federal drinking water standards.

Water quality data for the month of October (results of the combined filter effluent)

		Units	Results	Limits	
Turbidity	TU	NTU	<b>0.068</b>	0.3	<i>Monthly average, results should be less than limits to comply</i>
Total Dissolved Solids	TDS	mg/l	<b>150</b>	500	
Total Trihalomethanes	TTHM	µg/l	<b>48.5-48.9</b>	80	<i>Ranges from 4 distribution locations (Sep results)</i>
Haloacetic Acids	HAA	µg/l	<b>13.5-15.4</b>	60	
		Units	Results	Minimum Limit	
Total Organic Carbon	TOC	RAA Ratio	<b>1.17</b>	1.00	<i>* RAA Results should be greater than minimum limit to comply</i>

Reportable violations made to SWRCB: **NONE**

*\*RAA - Running Annual Average*

**Monthly Plant Production**

	Capacity	Monthly %
<b>Potable water produced from Miramar Plant</b>	<b>1939.2 AF</b>	<b>105.1%</b>

**Monthly Well Production**

	Days in service	Same month prior year	Days in service
Well #1	<b>31</b>	<b>31.6 AF</b>	<b>30</b>
Well #2	<b>31</b>	<b>88.5 AF</b>	<b>30</b>
<b>Total monthly Well production</b>		<b>121.0 AF</b>	<b>118.3 AF</b>

**Monthly Sales**

La Verne	<b>582.9 AF</b>	28.3%
GSWC (Claremont)	<b>626.4</b>	30.4%
GSWC (San Dimas)	<b>297.0</b>	14.4%
PWR-JWL	<b>551.8</b>	26.8%
Pomona (Mills)	<b>0.0</b>	0.0%
TVMWD Admin	<b>2.2</b>	0.1%
<b>Total Potable Water Sold</b>	<b>2060.2 AF</b>	<b>100.0%</b>

**Year To Date 2019-20**

	Actual	Budget	% of Budget
Potable Water Sold from Miramar Plant (93.8%)	<b>7,447.4 AF</b>	8,246.5 AF	90.3%
Total Well Production (6.2%)	<b>491.9</b>	414.3	118.7%
<b>Total Potable Water Sold (Plant &amp; Wells)</b>	<b>7,939.3 AF</b>	8,660.8 AF	91.7%

Average monthly water sold **1,984.8 AF**

**Hydroelectric Generation (kWh) FY 2019-20**

	Monthly kWh		YTD kWh		
	Actual	Budget	Actual	Budget	% of Budget
Miramar					
Hydro 1	0	138,403	0	387,529	0.0%
Hydro 2	0	19,217	4,956	73,665	6.7%
Hydro 3	0	38,953	3,138	149,319	2.1%
Williams	212,480	74,356	463,520	297,423	155.8%
Fulton	111,320	38,675	168,760	108,291	155.8%
	<b>323,800</b>	<b>309,604</b>	<b>640,374</b>	<b>1,016,227</b>	<b>63.0%</b>

**Operations/Maintenance Review**

Special Activities

- ▶ Operations staff did necessary preparation work and coordination in anticipation of the Solar Cup even on November 2.  
As part of keeping the treatment plant secure Operations staff began installing lockable selector switches to various pieces of equipment around the plant to prevent unauthorized changes.
- ▶ Operations staff participated in the annual Great California Shake Out.
- ▶ The purchase of a trailer-mounted hydro excavator with valve actuator was purchased for removing heavy sludge buildup from the bottom of the backwash ponds and is equipped with a pressurized nozzle. The valve actuator is GIS compatible to automatically record each valve's attributes.
- ▶ The DG area north of the Administration Building was restored to normal condition by Operations staff after being used as a staging area for the Grand Avenue Well construction.
- ▶ Per JPIA's request, concrete stairs were installed at the north side of the reservoirs.
- ▶ All system valves were turned for maintenance in September and October by Operations staff.
- ▶ The contractor has begun offsite fabrication of new wrought iron gates that will provide extra security to the Administration Building.
- ▶ The Fulton and Williams hydro's were online all month due to steady flows at the JWL.
- ▶ A global positioning system (GPS) device was purchased to improve the location and mapping for GIS.
- ▶ The consultants updated several components of the Risk Management Plan which is a requirement due to the storage of chlorine and ammonia at the treatment plant. Operations staff met with the LA County Fire Inspector to review the submittal and to view the chlorine and ammonia storage areas.

Outages/Repairs

- ▶ None

Unbudgeted Activities

- ▶ None

**Other**

- ▶ Several of the Operations staff attended the Leadership Breakfast at the Sheraton Fairplex and the PWAG luncheon at WVWD to meet all participating agencies.

Submitted by: \_\_\_\_\_



Steve Lang  
Chief Operations Officer





## Board of Directors Staff Report

**To:** TVMWD Board of Directors  
**From:** Matthew H. Litchfield, General Manager   
**Date:** November 20, 2019  
**Subject:** **FY 19-20 1<sup>st</sup> Quarter Reserve Schedule**

---

<input type="checkbox"/> <b>For Action</b>	<input type="checkbox"/> <b>Fiscal Impact</b>	<b>\$</b>
<input checked="" type="checkbox"/> <b>Information Only</b>	<input type="checkbox"/> <b>Funds Budgeted:</b>	

---

**Staff Recommendation:**

**No Action Necessary – Informational Item Only**

**Discussion:**

Attached for Board review is the Reserve Schedule as of September 30, 2019. This schedule identifies encumbered reserves that have been set aside for specific projects and Board designated reserves.

**Strategic Plan Objective(s):**

- 3.1 – Utilize and comply with a set of financial policies to maintain TVMWD’s financial health
- 3.3 – Be accountable and transparent with major decisions

**Attachment(s):**

Exhibit A – FY 19-20 1<sup>st</sup> Quarter Reserve Schedule

**Meeting History:**

None

NA/LC

**TVMWD RESERVES SCHEDULE**

FUND BALANCE	June 30, 2019 BALANCE	SOURCES	USES	TRANSFERS	September 30, 2019 BALANCE
<b>RESERVED FOR ENCUMBRANCE</b>					
Vehicle Replacement	4,844	40,000	-	-	44,844
Bldg Modifications-Bathroom Upgrades		50,000	-	-	50,000
Bldg Modifications-Operations Interior	313,429	-	-	-	313,429
Filter Aid System Upgrades	85,089		-	-	85,089
6th/White Connection Upgrade	64,584		(16,753)	-	47,832
Miramar Plant - Site Paving		55,000	-	-	55,000
Miramar - PAC Room Remodel		140,000	(17,600)	-	122,400
Carports	226,972	-	(5,000)	-	221,972
TVMWD Well - Grand Ave. Claremont	407,050	2,532,259	(1,341,107)	-	1,598,202
TVMWD Well - West Baseline Claremont	295,828	-	-	-	295,828
Land Acquisitions	750,000	-	-	-	750,000
JWL Control Valve	128,896	53,640	(190,669)	-	(8,133)
MiraGrand Well		43,147	(40,674)	-	2,473
Miramar Plant-Alternative Disinfectn		124,167	-	-	124,167
Fulton Reservoir-Residual Contrl Sys		200,000	-	-	200,000
Miramar Reservoir Effluent-Cover Str		105,000	(30,617)	-	74,383
Excavation/Valve Turning Trailer		175,000	-	-	175,000
	<b>\$ 2,276,692</b>	<b>\$ 3,518,213</b>	<b>\$ (1,642,418)</b>	<b>\$ -</b>	<b>\$ 4,152,487</b>

RESERVE GOAL
--------------

<b>BOARD DESIGNATED</b>					
Board Elections	\$ 83,637	38,180	-	-	\$ 121,817
Water Management	200,000	-	-	-	200,000
Water Rate Stabilization	1,353,755	-	-	-	1,353,755
Capital Asset R/R	5,549,353	-	-	-	5,549,353
Opportunity	2,500,000	-	-	-	2,500,000
Employee Benefits - Pension & OPEB	378,237	200,000	-	-	578,237
Emergency	-	-	-	-	-
	<b>\$ 10,064,982</b>	<b>\$ 238,180</b>	<b>\$ -</b>	<b>\$ -</b>	<b>\$ 10,303,162</b>

Lower	Upper
\$ 140,000	\$ 210,000
-	200,000
1,300,000	1,900,000
4,400,000	9,700,000
2,000,000	3,000,000
-	3,400,000
-	(303,162)
<b>\$ 7,840,000</b>	<b>\$ 18,106,838</b>



## Board of Directors Staff Report

**To:** TVMWD Board of Directors

**From:** Matthew H. Litchfield, General Manager 

**Date:** November 20, 2019

**Subject:** **Annual Consideration of Contributions to Pension and OPEB Trust**

---

<input checked="" type="checkbox"/> <b>For Action</b>	<input type="checkbox"/> <b>Fiscal Impact</b>	<b>\$</b>
<input type="checkbox"/> <b>Information Only</b>	<input checked="" type="checkbox"/> <b>Funds Budgeted:</b>	<b>\$200,000</b>

---

**Staff Recommendation:**

**Staff is recommending board approval to transfer \$200,000 from reserves to TVMWD's Pension Trust account.**

**Discussion:**

TVMWD established an IRS Section 115 Trust with PARS in November of 2016. The Trust provides for the ability to legally set-aside funds to reduce TVMWD's pension and OPEB liabilities.

- OPEB Trust
  - Balance of \$929,000 as of June 30, 2019, which represents a funded status of 82% of the OPEB liability less the "implicit subsidy".
  - The initial strategy decision was to maintain the Trust as 80-90% with the remaining balance kept in TVMWD reserves. The total funded status including TVMWD reserves is 98%.
  - Staff recommends no contribution currently.
- Pension Trust
  - Balance of \$415,000 as of June 30, 2019. Along with the funds held by CalPERS, the funded status of the pension liability is 81%.
  - TVMWD's goal is to accumulate and contribute \$200,000 per year to the Trust, which should fully fund pension liabilities by 2028.
  - Staff recommends a \$200,000 contribution to the pension trust as planned in the FY 19-20 budget.

**Strategic Plan Objective(s):**

- 3.1 – Utilize and comply with a set of financial policies to maintain TVMWD's financial health
- 3.3 – Be accountable and transparent with major decisions

**Attachment(s):**

None

**Meeting History:**

November 6, 2019

NA/JL



## THREE VALLEYS MUNICIPAL WATER DISTRICT 2020 BOARD MEETING AND CONFERENCE SCHEDULE

Adopted: **DRAFT**

LEGEND
Board Meetings
MWD Inspection Tours
District Holidays
Major Conferences
Leadership Breakfast

JANUARY 2020
Holiday - January 1
Board Meeting - January 1 <b>Cancelled</b>
Board Meeting - January 15
Leadership Breakfast - January 30

FEBRUARY 2020
Board Meeting - February 5
Holiday - February 17
Board Meeting - February 19

MARCH 2020
Board Meeting - March 4
CRA Inspection Tour - March 13-15
Board Meeting - March 18

APRIL 2020
Board Meeting - April 1
CA-NV Annual Spring Conference - April 6-9
Board Meeting - April 15

MAY 2020
ACWA Spring Conference - May 5-8
Board Meeting - May 6 - <b>Conflicts w/ACWA Conf.</b>
Board Meeting - May 20
Holiday - May 25
Leadership Breakfast - May 28 (Tentative)

JUNE 2020
Board Meeting - June 3
Diamond Valley Lake Tour - June 5
AWWA Annual Conference - June 14-17
Board Meeting - June 17

JULY 2020
Holiday - July 3
Board Meeting - July 1
Board Meeting - July 15
<b><i>July Board meetings subject to cancel</i></b>

AUGUST 2020
Board Meeting - August 5
Board Meeting - August 19
CSDA Annual Conference - August 24-27
<b><i>August Board meetings subject to cancel</i></b>

SEPTEMBER 2020
Holiday - September 7
Board Meeting - September 2
Board Meeting - September 16

OCTOBER 2020
Board Meeting - October 7
Board Meeting - October 21
CA-NV Fall Conference - TBD
Leadership Breakfast - October 29 (Tentative)

NOVEMBER 2020
Board Meeting - November 4
Holiday - November 11
Board Meeting - November 18
Holiday - November 26-27

DECEMBER 2020
ACWA Fall Conference - December 1-4
Board Meeting - December 2 - <b>Conflicts w/ACWA Conf.</b>
Board Meeting - December 16
Holiday - December 24-25
Holiday - December 31



## Board of Directors Staff Report

**To:** TVMWD Board of Directors  
**From:** Matthew H. Litchfield, General Manager   
**Date:** November 20, 2019  
**Subject:** **Approval of Organizational Chart Effective November 20, 2019**

<input checked="" type="checkbox"/> <b>For Action</b>	<input type="checkbox"/> <b>Fiscal Impact</b>	<b>\$</b>
<input type="checkbox"/> <b>Information Only</b>	<input type="checkbox"/> <b>Funds Budgeted</b>	

**Staff Recommendation:**

**Approval of the latest update to the TVMWD Organizational Chart**

**Discussion:**

Whenever revisions are made to the organizational chart of TVMWD, staff will provide an update to the Board for formal review and approval.

Attached is the latest edition of the organizational chart, reflecting the updated job titles and reporting assignments previously adopted by the Board, following the completion of the recent organizational study.

Once approved by the Board, the organizational chart will be posted to the TVMWD website.

**Strategic Plan Objective(s):**

- 3.2 – Maintain TVMWD website with useful information
- 3.3 – Be accountable and transparent with major decisions

**Attachment(s):**

Exhibit A – TVMWD Organizational Chart

**Meeting History:**

None

KH/ML



**Organizational  
Chart**

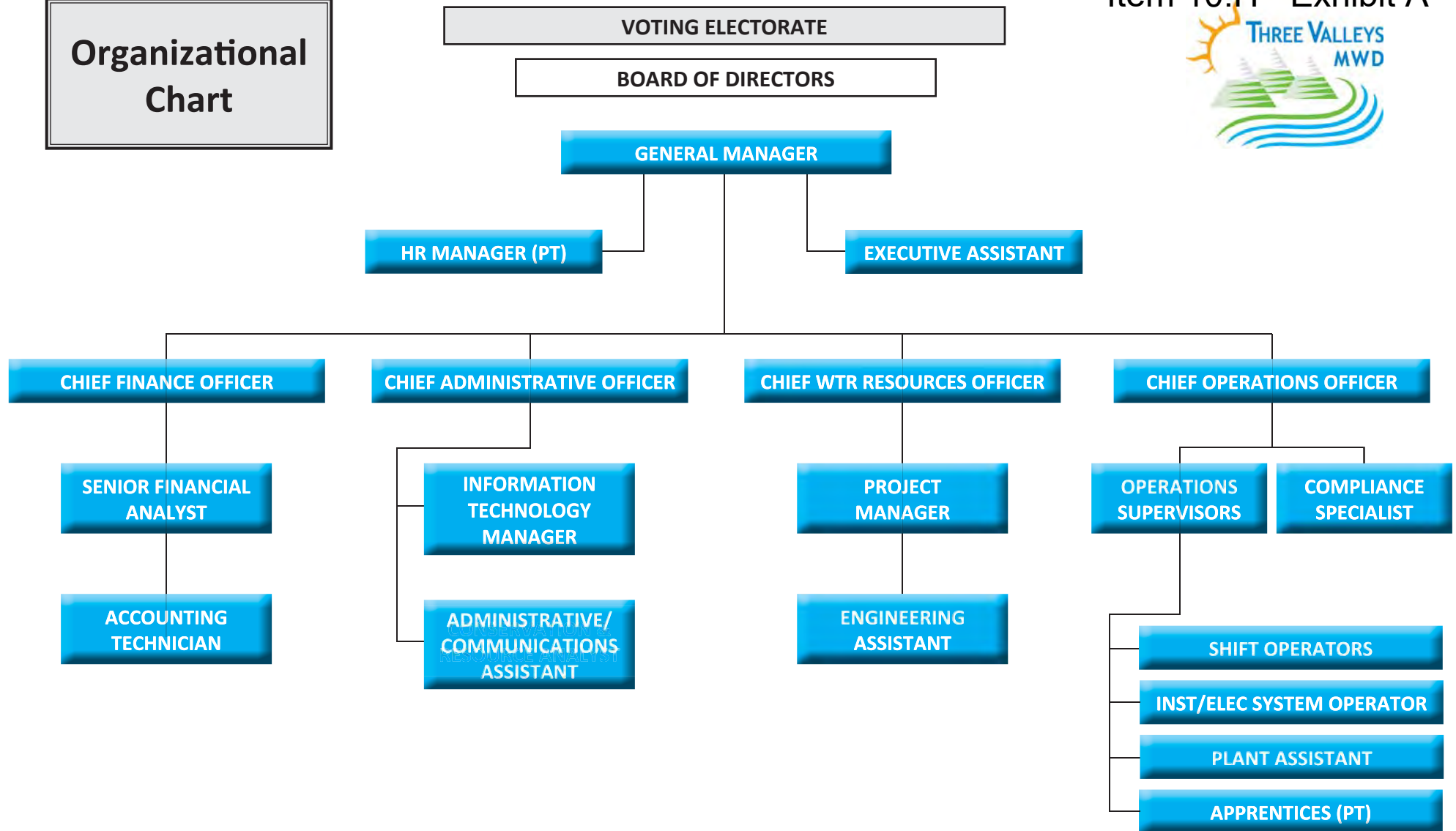

Matthew Litchfield, P.E.  
General Manager

November 20, 2019

Date



# DIRECTOR EXPENSE SHEET

**Submit Form**

## Item 11.A

**NAME:** Brian Bowcock, Division 3

**MONTH / YEAR**

October

2019

No	Day	Title of Meeting / Description	Mileage (assumed as round trip unless noted)				Meeting Compensation
			From City	To City	Miles	Miles \$	
1	2	TVMWD BOD meeting	La Verne	Claremont	10.0	\$ 5.80	\$ 200.00
Regular meeting to discuss issues in the district.							
2	15	Water Forum	La Verne	Azusa	20.0	\$ 11.60	\$ 200.00
Meeting of the 5 partners, to discuss the future forum in 2020.							
3	16	TVMWD bod meeting	La Verne	Claremont	10.0	\$ 5.80	\$ 200.00
Regular monthly meeting to discuss issues in the district.							
4	18	Citrus College Foundation meetings	La Verne	Glendora	18.0	\$ 10.44	\$ 200.00
Meetings for Finance, Promise Program Community outreach, investments COMMITTEES . All morning							
5	20	Cal/ Nev Section Conference	La Verne	San Diego	125.0	\$ 72.50	\$ 200.00
Working the conference as a lead volunteer and attending sessions.							
6	21	Cal/Nev Section Conference	La Verne				\$ 200.00
7	22	Cal/Nev Section Conference	La Verne				\$ 200.00
8	23	Cal/Nev Section Conference	La Verne				\$ 200.00
9	24	Cal/Nev Section Conference	San Diego	La Verne	125.0	\$ 72.50	\$ 200.00
10	31	TVMWD Leadership Breakfast meeting	La Verne				\$ 200.00
Regular Quarterly meeting of all the agencies in the district							

No	Day	Miscellaneous Expense (please itemize each expense)	Misc. Expense
1			
2			
3			
4			
5			

*I certify the above is correct and accurate to the best of my knowledge*

Signature \_\_\_\_\_

Subtotal Miscellaneous Expense	\$ 0.00
Subtotal Mileage	\$ 178.64
Subtotal Meeting Compensation	\$ 2,000.00
Subtotal All	\$ 2,178.64
Mandatory Deferred Compensation @ 7.5%	(\$ 150.00)
Voluntary Deferred Compensation <i>(negative entry; default @ 0)</i>	(\$ 800.00)
<b>TOTAL</b>	<b>\$ 1,228.64</b>

\* Mileage is reimbursed at IRS Standard Business Mileage Rate

\*\*Directors are eligible for ten meeting days per month at \$200 per day. Ordinance Nos. 02-01-7 and 02-07-15





# DIRECTOR EXPENSE SHEET

**Submit Form**

## Item 11.A

**NAME:** David De Jesus, MWD

**MONTH / YEAR**

October

2019

No	Day	Title of Meeting / Description	Mileage (assumed as round trip unless noted)				Meeting Compensation
			From City	To City	Miles	Miles \$	
1	1	San Gabriel Valley Directors Caucus Meeting					\$ 200.00
Attended the monthly meeting with several Directors to discuss issues and exchange information regarding various impacts to their respective areas. Reviewed the agenda for possible discuss with staff later in the week.							
2	3	Northern Caucus Meeting					\$ 200.00
Meeting with Northern Caucus directors and GM's along with MWD management staff to review published agenized items.							
3	4	Meeting with Operations Manager Brent Yamasaki					\$ 200.00
Meeting to discuss water deliveries and supplies throughout the service area including water stored. Water quality conditions were also reviewed.							
4	7	Committee Meetings					\$ 200.00
Attended various meetings to discuss staff recommendations slated for action at the upcoming board meeting.							
5	8	Board Meeting					\$ 200.00
Attended the board meeting as required and took action on staff recommended items. Oral report pending at the Three Valleys Board Meeting							
6	9	Colorado River Board Meeting					\$ 200.00
Attended the meeting as the Districts Governors appointee alternate. Various reports were provided on the condition of the reservoirs in the CRA system and the potential impacts to neighboring states under the new drought contingency program parameters.							
7	14	SGV Regional Chamber Legislative Committee Meeting					\$ 200.00
The committee met and received a presentation from Prime Strategies on "Fight for Prop 14 Coalition. Action was taken by the group to "support" opposing the bill and join the fight against the move to alter the proposition and initiate a "split-role" approach increasing the property taxes for local businesses.							
8	18	MWD Security Meeting					\$ 200.00
Meeting to discuss progress being made on various issues including cyber security upgrades and facility security updates including those to HQ. Staff training has been scheduled and should be rolling out soon to HQ staff and others as time and schedules permit.							
9	25	SGV Regional Chamber Legislative Power Luncheon					\$ 200.00
Attended the meeting and was afforded the privilege of introducing California's State Treasure Fiona Ma. The meeting included a number of subject matters including housing, homelessness, and opportunities that the State can provide to assist in a number of areas to help cities get project done.							
10	29	Monthly Update Meeting held with Deven Upadhyay					\$ 200.00
Meeting with the COO Upadhyay to discuss strategies developing from the recent Board Retreat.							

No	Day	Miscellaneous Expense (please itemize each expense)	Misc. Expense
1			
2			
3			
4			
5			

*I certify the above is correct and accurate to the best of my knowledge*

Signature \_\_\_\_\_

Subtotal Miscellaneous Expense	\$ 0.00
Subtotal Mileage	\$ 0.00
Subtotal Meeting Compensation	\$ 2,000.00
Subtotal All	\$ 2,000.00
Mandatory Deferred Compensation @ 7.5%	(\$ 150.00)
Voluntary Deferred Compensation <i>(negative entry; default @ 0)</i>	(\$ 891.50)
<b>TOTAL</b>	<b>\$ 958.50</b>

\* Mileage is reimbursed at IRS Standard Business Mileage Rate

\*\*Directors are eligible for ten meeting days per month at \$200 per day. Ordinance Nos. 02-01-7 and 02-07-15



# DIRECTOR EXPENSE SHEET

**Submit Form**

## Item 11.A

**NAME:** David De Jesus, Division 2

**MONTH / YEAR**

October

2019

No	Day	Title of Meeting / Description	Mileage (assumed as round trip unless noted)				Meeting Compensation
			From City	To City	Miles	Miles \$	
1	2	Board Workshop Meeting	Walnut	Claremont	38.0	\$ 22.04	\$ 200.00
The board was presented with a presentation by Mr. Michael Thomas of the Pomona Valley Americas Job Center regarding training opportunities for students enrolled at the Bassett Adult School in La Puente. In addition the board was provided with Sacramento Legislative update from its long time lobbyist Mike Arnold and Associates.							
2	10	Chino Basin Appropriative Committee Meeting	Walnut	Rancho C	42.0	\$ 24.36	\$ 200.00
The Committee was provided with an update to the 2019 Rules and Regulations revision. The keep item of discussion was related to Section 8.2 on Storage. Further discussions will be scheduled to obtain additional input before making recommendations for Water Master Board consideration. The OBMP Update Listening Session #7 was scheduled for 9:30AM on 10/17/2019.							
3	15	Meeting the President of the Board	Walnut	Glendora	18.0	\$ 10.44	\$ 200.00
A meeting was requested by the President of the board to discuss personnel issues. Including was the process and method to be employed for the evaluation of the GM based on his length of service with the district.							
4	16	Board Meeting	Walnut	Claremont	38.0	\$ 22.04	\$ 200.00
Attended the board as required and took action as appropriate refer to agenda for details. In addition I reported on actions and activities associated with MWDSC and the Districts representative to the board.							
5	17	Chino Basin Advisory Committee Meeting	Walnut	Rancho C.	42.0	\$ 24.36	\$ 200.00
Staff reports to the Committee included status report on the OBMP (Optimal Basin Management Plan), Storage Management Plan, Restated Judgment Amendment.							
6	21	Walnut Valley Water District Board Meeting	Walnut	Walnut	4.0	\$ 2.32	\$ 200.00
Attended the board meeting and availed myself to the board to address any questions of concerns or interest as it related to the MWDSC.							
7	24	Chino Basin Water Master Board Meeting	Walnut	Rancho C	42.0	\$ 24.36	\$ 200.00
Attended the Board meeting as the alternate voting member. various reports were provided by staff on workshops conducted throughout the month including engineering analysis on storage for the development of agreements. It was announced that meetings to discuss the basin safe yield reset as required by the courts would begin early next year.							
8	28	San Gabriel Valley Water Association	Walnut	Azusa	20.0	\$ 11.60	\$ 200.00
Reported on activities from TVMWD (Leadership breakfast at the end of the month and the ACWA Legislative efforts award) and provided the group with an update the MWD 2 day board retreat (with the emphasis on the future IRP and water supply requirements and Financial planning needs of the District).							
9	30	Water Industry Career Pathways w/ American Job Center	Walnut	Claremont	38.0	\$ 22.04	\$ 200.00
Met with Directors and individuals of the Career Pathways Job Center to brain storm potential opportunities for the students in the water industry.							
10	31	Quarterly District Leadership Breakfast	Walnut	Pomona	14.0	\$ 8.12	\$ 200.00
Titled "Tapping existing infrastructure to create water supply and water quality benefits" presented by Dave Pedersen GM of the Las Virgenes Municipal Water District.							

No	Day	Miscellaneous Expense (please itemize each expense)	Misc. Expense
1			
2			
3			
4			
5			

Subtotal Miscellaneous Expense    \$ 0.00

Subtotal Mileage    \$ 171.68

Subtotal Meeting Compensation    \$ 2,000.00

Subtotal All    \$ 2,171.68

Mandatory Deferred Compensation @ 7.5%    (\$ 150.00)

Voluntary Deferred Compensation *(negative entry; default @ 0)*    (\$ 891.50)

**TOTAL**    **\$ 1,130.18**

*I certify the above is correct and accurate to the best of my knowledge*

\_\_\_\_\_  
Signature

\* Mileage is reimbursed at IRS Standard Business Mileage Rate

\*\*Directors are eligible for ten meeting days per month at \$200 per day. Ordinance Nos. 02-01-7 and 02-07-15



# DIRECTOR EXPENSE SHEET

**Submit Form**

## Item 11.A

**NAME:** Carlos Goytia, Division 1

**MONTH / YEAR**

October

2019

No	Day	Title of Meeting / Description	Mileage (assumed as round trip unless noted)				Meeting Compensation
			From City	To City	Miles	Miles \$	
1	1	Meet w/Community Group	Pomona	Pomona	8.0	\$ 4.64	\$ 200.00
Discussed water related issues/Pomona water rate							
2	2	TVMWD Board Meeting	Pomona	Claremont	32.0	\$ 18.56	\$ 200.00
Board room discussion and deliberations							
3	4	SGVCOG - Foothill Goldline Contract Signing	Pomona	Pomona	8.0	\$ 4.64	\$ 200.00
Met with Mayor Garcetti, Supervisor Solis Mayor Sandoval and Elected Official from the Entire Region							
4	7	Pomona City Council Meeting	Pomona	Pomona	8.0	\$ 4.64	\$ 200.00
Met w/Mayor Sandoval & several staff							
5	9	SGVRC - Netgo	Pomona	Diamond Bar	12.0	\$ 6.96	\$ 200.00
Meet w/Councilmember Andrew Chou and network							
6	11	Meeting w/Councilmember V. Preciado	Pomona	Pomona	8.0	\$ 4.64	\$ 200.00
Met w/Councilmember and D. Paulson to discuss water related issues							
7	16	TVMWD Board Member	Pomona	Claremont	32.0	\$ 18.56	\$ 200.00
Board room discussion and deliberations							
8	17	SCWUA	Pomona	Pomona	8.0	\$ 4.64	\$ 200.00
Luncheon & guest speaker							
9	24	Meeting w/Mayor Sandoval & C.M. Preciado	Pomona	Pomona	8.0	\$ 4.64	\$ 200.00
Met to discuss regional & City related business and issues w/staff from Senator Leyva office & regional stakeholders							
10	30	Meeting w/Mayor Sandoval	Pomona	Pomona	8.0	\$ 4.64	\$ 200.00
1 on 1 to discuss water rate increase and potential projects and City related issues							

No	Day	Miscellaneous Expense (please itemize each expense)	Misc. Expense
1			
2			
3			
4			
5			

*I certify the above is correct and accurate to the best of my knowledge*

Signature \_\_\_\_\_

Subtotal Miscellaneous Expense	\$ 0.00
Subtotal Mileage	\$ 76.56
Subtotal Meeting Compensation	\$ 2,000.00
Subtotal All	\$ 2,076.56
Mandatory Deferred Compensation @ 7.5%	(\$ 150.00)
Voluntary Deferred Compensation <i>(negative entry; default @ 0)</i>	\$ 0.00
<b>TOTAL</b>	<b>\$ 1,926.56</b>

\* Mileage is reimbursed at IRS Standard Business Mileage Rate

\*\*Directors are eligible for ten meeting days per month at \$200 per day. Ordinance Nos. 02-01-7 and 02-07-15



# DIRECTOR EXPENSE SHEET

**Submit Form**

## Item 11.A

**NAME:** Denise Jackman, Division VII

**MONTH / YEAR**

October

2019

No	Day	Title of Meeting / Description	Mileage (assumed as round trip unless noted)				Meeting Compensation
			From City	To City	Miles	Miles \$	
1	2	Three Valleys Municipal Water District - Board of Directors Meeting	Rowland Heights	Claremont	46.0	\$ 26.68	\$ 200.00
Review board issues and vote on agenda issues.							
2	3	Puente Basin Water - Board of Directors meeting	Rowland Heights	Rowland Heights	2.0	\$ 1.16	\$ 200.00
Observe meeting of Board of Directors meeting.							
3	8	Rowland Water District - Board of Directors Meeting	Rowland Heights	Rowland Heights	2.0	\$ 1.16	\$ 200.00
Observe meeting of Board of Directors and issues within their district.							
4	16	Three Valleys Municipal Water District - Board of Directors Meeting	Rowland Heights	Claremont	46.0	\$ 26.68	\$ 200.00
Review board issues and vote on agenda issues.							
5	18	Leadership Training - Chino Watermaster	Rowland Heights	Claremont	46.0	\$ 26.68	\$ 200.00
Attend training program held by Chino Watermaster and hosted by Three Valleys.							
6	12	CIE - Awards Presentation	Rowland Heights	Diamond Bar	8.2	\$ 4.76	\$ 200.00
Attended Chinese International Engineering Award Ceremony. TVMWD Sponsored.							
7	22	Rowland Water District	Rowland Heights	Rowland Heights	2.0	\$ 1.16	\$ 200.00
Ethics and Civility training.							
8	24	PWR-JWL Commissioner's Meeting	Rowland Heights	Walnut	8.2	\$ 4.76	\$ 200.00
Attended and was updated on issues related to JWL.							
9	25	4th Annual State of the Schools Breakfast Rowland Unified School District	Rowland Heights	Rowland	2.0	\$ 1.16	\$ 200.00
Represented TVMWD at sponsored event.							
10	31	Three Valleys Leadership Breakfast	Rowland Heights	Pomona	26.0	\$ 15.08	\$ 200.00
Leadership breakfast with speaker from Valencia Water District on issues related to recycled water.							

No	Day	Miscellaneous Expense (please itemize each expense)	Misc. Expense
1	16	TSA Pre-Check Enrollment	\$ 85.00
2			
3			
4			
5			

*I certify the above is correct and accurate to the best of my knowledge*

Signature \_\_\_\_\_

Subtotal Miscellaneous Expense	\$ 85.00
Subtotal Mileage	\$ 109.27
Subtotal Meeting Compensation	\$ 2,000.00
Subtotal All	\$ 2,194.27
Mandatory Deferred Compensation @ 7.5%	(\$ 150.00)
Voluntary Deferred Compensation <i>(negative entry; default @ 0)</i>	\$ 0.00
<b>TOTAL</b>	<b>\$ 2,044.27</b>

\* Mileage is reimbursed at IRS Standard Business Mileage Rate

\*\*Directors are eligible for ten meeting days per month at \$200 per day. Ordinance Nos. 02-01-7 and 02-07-15



---

**Service Details:**

Date: 10/16/2019 @ 03:54 PM (PDT)  
Customer: DENISE JACKMAN  
UE ID: [REDACTED]

**Services**

[REDACTED] TSA Pre✓® Enroll \$85.00  
**Total: \$85.00**

**Payments**

Card([REDACTED]) \$85.00  
Auth Number: 02136D

**Amount Paid as of (10/16/2019) \$85.00**

---

**Status as of 10/16/19**

**Enrollment Received**

Your enrollment has been received and is being processed for delivery to TSA.

---

[Click here to check your status](#)



# DIRECTOR EXPENSE SHEET

**Submit Form**

## Item 11.A

**NAME:** Bob Kuhn, Division 4

**MONTH / YEAR**

October

2019

No	Day	Title of Meeting / Description	Mileage (assumed as round trip unless noted)				Meeting Compensation
			From City	To City	Miles	Miles \$	
1	2	Board Workshop	Glendora	Claremont	20.0	\$ 11.60	\$ 200.00
See the agenda for issues discussed and send on for board approval							
2	3	Glendora Chamber of Commerce Legislative Committee	Glendora	Glendora	4.0	\$ 2.32	\$ 200.00
Work on Legislation beneficial or of concern to the merchants of Glendora							
3	15	Meeting with VP of the board	Glendora	Glendora	0.0	\$ 0.00	\$ 200.00
Talked about how General Manager review process upcoming							
4	21	SGV Talk Group	Glendora	Monrovia	24.0	\$ 13.92	\$ 200.00
Issues of interest to the San Gabriel Valley cities - New voter time frame and demonstration of online voting							
5	24	Meeting with former Mayors of Glendora	Glendora	Glendora	4.0	\$ 2.32	\$ 200.00
Discussions on South Hills and some of the water issues in the Dalton Canyon							
6	31	TVMWD Leadership Breakfast/David Pedersen	Glendora	Pomona	16.0	\$ 9.28	\$ 200.00
Current water issues							
7			Glendora				
8			Glendora				
9			Glendora				
10			Glendora				

No	Day	Miscellaneous Expense (please itemize each expense)	Misc. Expense
1			
2			
3			
4			
5			

*I certify the above is correct and accurate to the best of my knowledge*

Signature \_\_\_\_\_

Subtotal Miscellaneous Expense	\$ 0.00
Subtotal Mileage	\$ 39.44
Subtotal Meeting Compensation	\$ 1,200.00
Subtotal All	\$ 1,239.44
Mandatory Deferred Compensation @ 7.5%	(\$ 90.00)
Voluntary Deferred Compensation <i>(negative entry; default @ 0)</i>	(\$ 1,110.00)
<b>TOTAL</b>	<b>\$ 39.44</b>

\* Mileage is reimbursed at IRS Standard Business Mileage Rate

\*\*Directors are eligible for ten meeting days per month at \$200 per day. Ordinance Nos. 02-01-7 and 02-07-15



# DIRECTOR EXPENSE SHEET

**Submit Form**

## Item 11.A

**NAME:** John Mendoza, Division 6

**MONTH / YEAR**

October

2019

No	Day	Title of Meeting / Description	Mileage (assumed as round trip unless noted)				Meeting Compensation
			From City	To City	Miles	Miles \$	
1	2	TVMWD Board of Directors Meeting	Pomona	Claremont			\$ 200.00
Meeting of Board of Directors to discuss issues and vote on projects important to the district							
2	4	Foothill Gold Line Funding City of Pomona	Pomona	Pomona			\$ 200.00
Gathering of elected officials and community to get informed of the needed transportation funding Gold Line							
3	10	ACWA Region 9 tour and program	Pomona	Rancho Cucamonga			\$ 200.00
Tour of Rancho Cucamonga water facilities and program about education of new water professionals.							
4	14	SGV Regional Chamber Affairs Luncheon	Pomona	Diamond Bar			\$ 200.00
Meeting of businesses and elected officials to discuss and vote on important legislation.							
5	16	T1-T2 AWWA	Pomona				\$ 200.00
All day class related to water treatment and math related to T1-T2 State certification for water treatment.							
6	17	SCWUA Luncheon	Pomona	Pomona			\$ 200.00
The Future of Water Management presentation by Drew Mouton. New laws and issues affecting region water agencies.							
7	21	SGV Regional Chamber HR Forum	Pomona	Baldwin Park			\$ 200.00
Focus on dealing and resolving claims related to mental illness in the duty of employment. Conflict resolutions steps to avoid be sued.							
8	23	Six Basins Watermaster	Pomona	Baldwin Park			\$ 200.00
Meeting of stakeholders in the Basin to discuss important water issues.							
9	25	SGV Regional Chamber Power Luncheon	Pomona	Baldwin Park			\$ 200.00
State Treasure Fiona Ma, Hilda Solis and Mayor of Walnut Rodriguez gave presentation about issues in the region							
10	31	TVMWD Leadership Breakfast	Pomona	Pomona			\$ 200.00
Meeting of Regional water agencies and elected officials, business to learn important topics. MWD Petersen presentation focused on social media out reach.							

No	Day	Miscellaneous Expense (please itemize each expense)	Misc. Expense
1			
2			
3			
4			
5			

Subtotal Miscellaneous Expense \$ 0.00

Subtotal Mileage \$ 0.00

Subtotal Meeting Compensation \$ 2,000.00

Subtotal All \$ 2,000.00

Mandatory Deferred Compensation @ 7.5% (\$ 150.00)

Voluntary Deferred Compensation *(negative entry; default @ 0)* \$ 0.00

**TOTAL \$ 1,850.00**

*I certify the above is correct and accurate to the best of my knowledge*

\_\_\_\_\_  
Signature

\* Mileage is reimbursed at IRS Standard Business Mileage Rate

\*\*Directors are eligible for ten meeting days per month at \$200 per day. Ordinance Nos. 02-01-7 and 02-07-15



# DIRECTOR EXPENSE SHEET

**Submit Form**

## Item 11.A

**NAME:** Joe Ruzicka, Division 5

**MONTH / YEAR**      October      2019

No	Day	Title of Meeting / Description	Mileage (assumed as round trip unless noted)				Meeting Compensation
			From City	To City	Miles	Miles \$	
1	2	TVMWD - Board Meeting	Diamond Bar	Claremont	40.0	\$ 23.20	\$ 200.00
Attended and participated in the proceedings.							
2	8	RWD - Board Meeting	Diamond Bar	Rowland Hgts.	14.0	\$ 8.12	\$ 200.00
Attended and apprised myself of issues of concern to a member agency.							
3	16	LAFCO - Commission Meeting	Diamond Bar	Los Angeles	30.0	\$ 17.40	\$ 200.00
4	17	SCWUA - Membership Meeting	Diamond Bar	Pomona	22.0	\$ 12.76	\$ 200.00
Attended and heard a presentation on how data is combined in our operations.							
5	21	WVWD - Board Meeting	Diamond Bar	Walnut			\$ 200.00
Attended and apprised myself of issues of concern to a member agency.							
6	22	RWD - Ethics Training	Diamond Bar	Rowland Hgts.	14.0	\$ 8.12	\$ 200.00
7	24	SGV Lincoln Club - Membership Meeting	Diamond Bar	Covina	26.0	\$ 15.08	\$ 200.00
8	31	TVMWD - Leadership Breakfast	Diamond Bar	Pomona	22.0	\$ 12.76	\$ 200.00
Attended and heard a presentation on the treatment of water at several water districts in the state of California.							
9			Diamond Bar				
10			Diamond Bar				

No	Day	Miscellaneous Expense (please itemize each expense)	Misc. Expense
1			
2			
3			
4			
5			

*I certify the above is correct and accurate to the best of my knowledge*

\_\_\_\_\_  
Signature

Subtotal Miscellaneous Expense	\$ 0.00
Subtotal Mileage	\$ 97.44
Subtotal Meeting Compensation	\$ 1,600.00
Subtotal All	\$ 1,697.44
Mandatory Deferred Compensation @ 7.5%	(\$ 120.00)
Voluntary Deferred Compensation <i>(negative entry; default @ 0)</i>	\$ 0.00
<b>TOTAL</b>	<b>\$ 1,577.44</b>

\* Mileage is reimbursed at IRS Standard Business Mileage Rate

\*\*Directors are eligible for ten meeting days per month at \$200 per day. Ordinance Nos. 02-01-7 and 02-07-15





## Board of Directors Staff Report

**To:** TVMWD Board of Directors  
**From:** Matthew H. Litchfield, General Manager   
**Date:** November 20, 2019  
**Subject:** **Legislative Update – November 2019**

---

<input type="checkbox"/> <b>For Action</b>	<input type="checkbox"/> <b>Fiscal Impact</b>	<b>\$</b>
<input checked="" type="checkbox"/> <b>Information Only</b>	<input type="checkbox"/> <b>Funds Budgeted</b>	

---

**Staff Recommendation:**

**No Action Necessary – Informational Item Only**

**Discussion:**

As we conclude the first year of the two-year legislative cycle, attached for Board review are the legislative highlights from the year and a summary report on some of the key bills we followed. In total, we took action on 20 bills, supporting 9, opposing 9 and going neutral on two bills that we initially had been tracking. All in all, the results were favorable. Three of the bills we supported were signed into law and eight of the nine we opposed did not advance. All bills signed into law during the recently concluded legislative session become effective January 1, 2020.

During the first meeting in January, staff will provide the board with the legislative calendar for the new year along with a list of updated legislative priorities TVMWD will be engaged in during 2020.

**Strategic Plan Objective(s):**

1.7 – Advocate for a Bay-Delta fix

3.5 – Ensure that all of the region’s local government policy makers understand TVMWD’s role in the delivery of water.

**Attachment(s):**

Exhibit A – 2019 Legislative Highlights

**Meeting History:**

None

KH/ML

**Arnold and Associates, Inc.**

Legislative Advocates and Consultants

Phone: (916) 446-2646 ♦ Fax: (916) 446-6095 ♦ 1127 11th Street, Suite 820, Sacramento, CA 95814

---

**Three Valley Municipal Water District**

**LEGISLATIVE HIGHLIGHTS  
2019 LEGISLATIVE YEAR**

**October 17, 2019**

**Prepared by:  
Michael Arnold  
Kristi Foy**

**2019-2020 Regular Session**

The 2019 legislative year has now ended. This was the first year of the 2019-2020 biennial legislative session. During the rest of the fall, the Legislature will hold interim hearings on various topics. The State Legislature will return to Sacramento on Monday, January 6, 2020, to begin the second year of the two-year session.

**Effective Dates of New Legislation**

The bills that were passed this year by the Legislature and signed by the Governor will take effect on January 1, 2020 unless they include an urgency clause or contain a provision calling for some other effective date. Urgency measures take effect immediately upon chaptering by the Secretary of State. Bills are normally chaptered on the day following their signature by the Governor.

**Two Year Bills**

Since this was the first year of the biennial session, bills not passed to the Governor's desk remain alive for consideration during next year. The rules provide that these measures must pass the house of origin by the end of January to remain alive for additional consideration. Thus, January will be a busy month.

**Key Bills for 2019**

**AB 100 (Budget Committee) Drinking Water**

There were several bills this year that sought to implement the "Safe and Affordable Drinking Water Fund." Different bills took various approaches to the fund and how to

finance it with either general fund money, a water tax or other means. TVMWD was strongly opposed to a water tax. We worked closely with other coalition members in opposition to a water tax. We supported this version of the language because it did not include a tax. AB 100 was held on the Senate Floor. Ultimately, much of the language of this bill was picked up as a part of the final budget package. AB 100 was held in the Senate Budget & Fiscal Review Committee.

### **AB 217 (E. Garcia) Safe drinking water fund with a water tax**

AB 217 was another version of safe drinking water fund; however, this version included a new water tax for California. We oppose this version of the fund language because it proposes a water tax as a funding mechanism. AB 217 would turn public water systems into tax collectors by requiring them to send a water tax to the state based on the number of system connections. We are happy to report that SB 200 passed which creates the water fund without a tax. Ultimately AB 217 was amended and used for a different subject matter.

### **AB 441 (Eggman) Water – Underground Storage**

This bill revises the beneficial use doctrine for water rights to provide the diversion of water to underground storage, including the diversion of water for groundwater recharge, constitutes beneficial use for which an appropriation may be made if the diverted water is put to beneficial use. Additionally, this bill provides the forfeiture periods of a water right do not include any period when the water is being used in the aquifer or storage area or is being held in underground storage for later application to beneficial use.

Currently, diversion to underground storage is considered a beneficial use only if the surface water is stored in the ground and then subsequently extracted for a consumptive beneficial use. Some of the beneficial uses defined in current regulations include recreational use, domestic use, irrigation, power generation, and municipal and industrial use, but prevention of salinity intrusion and subsidence are not included.

The withdrawal and beneficial use of that stored water has to occur within five years or the right to that water is forfeited. This bill sought to eliminate the five-year forfeiture period. California's water law and policy, Article X, Section 2 of the California Constitution, requires that all uses of the state's water be both reasonable and beneficial. It places limitations on water rights by prohibiting the waste, unreasonable use, unreasonable method of use or unreasonable method of diversion of water. The bill sought to change California law by allowing the permeant storage of water underground to be a beneficial use. The bill did not provide sufficient safeguards to existing water rights and for that reason we opposed this bill. AB 441 was held in the Assembly Appropriations Committee.

### **AB 510 (Cooley) Local Government Records: Destruction of Records**

Existing law authorizes the head of a department of a county or city, or the head of a special district to destroy recordings of routine video monitoring maintained by that county, city, or special district after one year if that person receives approval from the legislative body and the

written consent of the agency attorney. Existing law authorizes the head of a department of a county or city, or the head of a special district to destroy recordings of telephone and radio communications maintained by that county, city, or special district after 100 days if that person receives approval from the legislative body and the written consent of the agency attorney. This bill would exempt the head of a department of a county or city, or the head of a special district from these recording retention requirements if the county, city, or special district adopts a records retention policy governing recordings of routine video monitoring and recordings of telephone and radio communications. We supported this bill. This bill allows public agencies to diligently manage their financial and equipment resources by setting their own records retention policies for recordings related to routine video monitoring, radio and telephones. AB 510 was held as a two-year bill in the Assembly Local Government Committee.

### **AB 533 (Holden) Income Taxes: Exclusion: turf removal water conservation projects**

AB 533 would exclude from gross income amounts received as a rebate, voucher, or other financial incentive issued by a water service provider for participation in a turf removal program. We supported this bill because it is well documented that rebates substantially increase adoption of water use efficiency strategies. AB 533 is helpful to incentivize homeowners to make important investments in turf removal projects to protect our critical water resources. AB 533 was held as a two-year bill in the Assembly Appropriations Committee.

### **AB 1184 (Gloria) Public records: writing transmitted by electronic mail: retention**

AB 1184 addresses the question of how long public agencies must retain electronic writings or emails. The bill requires a public agency to retain and preserve for at least two years every writing containing information relating to the conduct of the public's business that is prepared, owned, or used by the public agency and transmitted by electronic mail, unless a statute or regulation, or a rule established by the Secretary of State pursuant to the State Records Management Act, requires a longer retention period. We opposed this bill because the retention will prove costly and because the provision is placed in the California Public Records Act (CPRA), these costs will not be reimbursed as a state mandate. CPRA already creates burdens on public agencies in terms of staff time responding to requests. Given the volume of electronic mail generated, a mandatory retention period of two years would place even greater burdens on agencies in terms of reviewing and identifying relevant e-mail. AB 1184 was vetoed by the Governor.

### **AB 1194 (Frazier) Sacramento-San Joaquin Delta: Delta Stewardship Council**

AB 1194 sought to increase the membership of the Delta Stewardship Council to 13 members, with a majority representing in-Delta interests. The bill would have expanded the composition of the Delta Stewardship Council (Council) from seven voting members to eleven voting members and two nonvoting members. This bill represented a step backwards in a statewide approach to resolving and balancing statewide interests. For all of these reasons, we opposed AB 1194. AB 1194 was held in the Assembly Water, Park and Wildlife Committee.

## **AB 1204 (Rubio) Public Water Systems: primary drinking water standards: implementation date**

AB 1204 would establish a three-year compliance period, with a potential additional two years, for any new primary drinking water standard for contaminants, known as MCLs, which are adopted by the State Water Resources Control Board. This bill would allow water systems a responsible timeline, similar that of the U.S. Environmental Protection Agency (EPA) to comply with new MCLs in a more cost-effective and feasible manner. For these reasons we supported AB 1204. This bill is specific to any adopted MCL not regulated by an EPA primary drinking water standard or one that is more stringent than a federal primary drinking water standard adopted by the EPA. AB 1204 was held as a two-year bill in the Committee on Environmental Safety and Toxic Materials.

## **AB 1486 (Ting) Surplus Land**

AB 1486 expands the Surplus Land Act requirements for local agencies, requires local governments to include specified information relating to surplus lands in their housing elements and annual progress reports (APRs), and requires the state Department of Housing and Community Development (HCD) to establish a database of surplus lands, as specified. The author argued that California is facing an affordable housing crisis and unused public land has the potential to promote affordable housing development throughout the state. This bill clarifies provisions in the Surplus Land Act that seeks to promote the use of public land for affordable housing projects. As first introduced, this bill imposed onerous new requirements on the disposition of surplus land and did not take into consideration the unique needs of various local agencies and special districts.

We worked with the California Special Districts Association to seek amendments to the bill. The bill was substantially amended during the course of its consideration which did improve the bill. AB 1486 was signed by the Governor as Chapter 664, Statutes of 2019.

## **AB 1580 (Levine) Major Infrastructure Construction Projects: oversight committees**

AB 1580 would require a state agency undertaking a publicly funded major infrastructure construction project that is estimated to cost \$1 billion or more to establish and oversight committee and a comprehensive risk management plan. This bill will hinder critical infrastructure projects and add unnecessary costs. We opposed this bill along with a coalition of water partners because it appeared that the bill was aimed at the new Delta conveyance. We worked closely with the coalition to get the bill held in the Senate Appropriations Committee. AB 1580 was held as a two-year bill in the Senate Appropriations Committee

## **SB 1 (Atkins) California Environmental, Public Health, and Workers Defense Act of 2019**

SB 1 sought to enact the California Environmental, Public Health, and Workers Defense Act of 2019 (Act) with the purpose of ensuring that protections afforded to Californians under federal environmental and labor laws and regulations as of January 2017, remain in place in the event that President Trump weakens or repeals any of those federal laws or regulations. This bill was introduced to respond to the Trump Administration's attack on laws and regulations that protect public health and the environment. We opposed the bill and requested a veto from Governor

Newsom because it threatened the more collaborative approach to water management in the Sacramento and San Joaquin watershed. Important negotiations known as the Voluntary Agreements, are the only real chance to avoid protracted and expensive litigation and make real progress in the Delta. SB 1 would have disrupted this process. We were very pleased that the Governor vetoed SB 1.

### **SB 101 (Budget Committee) Drinking Water**

SB 101 was one of the budget trailer bills being considered to implement the Safe and Affordable Drinking Water Fund. We opposed this version of the language because SB 101 does not prioritize the funding for disadvantaged communities and low-income households. Also, this bill would greatly expand the scope of the program beyond making sure that there is access to safe drinking water. We were successful in stopping this version of the language. SB 101 was held as a two-year bill in Assembly Budget Committee.

### **SB 200 (Monning) Drinking Water**

This bill establishes the Safe and Affordable Drinking Water Fund (SADWF) to help water systems provide an adequate and affordable supply of safe drinking water in both the near and the long term. Beginning in fiscal year 2020-21 and until June 30, 2030, it annually transfers to the Safe and Affordable Drinking Water Fund five percent of the proceeds of the Greenhouse Gas Reduction Fund (GGRF) up to \$130 million. It further requires the State Water Resources Control Board (SWRCB) to adopt a fund implementation plan and requires expenditures of the fund to be consistent with the plan. We strongly supported this version of the Fund language. The bill will assist communities and individual domestic well owners who currently lack access to safe drinking water, particularly in small, disadvantaged communities. SB 200 was signed by the Governor as Chapter 120, Statutes of 2019.

### **SB 204 (Dodd) State Water Project: contracts.**

SB 204 revises the notification provisions regarding pending State Water Project (SWP) contract negotiations and contract amendments, and explicitly requires the California Water Commission to review and report on the progress of the design, construction, and operation of any new Delta conveyance facility as a part of its annual review of the SWP. We oppose SB 204 because it creates cumbersome legislative reporting requirements that are unprecedented public works project in California. We were pleased that the bill was held as a two-year bill in the Assembly Water Parks and Wildlife.

### **SB 307 (Roth) Water Conveyance: use of facility with unused capacity**

Requires the State Lands Commission (SLC), in consultation with the Department of Fish and Wildlife (DFW) and the Department of Water Resources (DWR), to find that the transfer of the water from a groundwater basin underlying specified desert lands will not adversely affect the natural or cultural resources, including groundwater resources or habitat, of those federal and state lands in order for that transfer to be allowed. We joined many others in opposition to this bill because it puts at risk the Cadiz Valley Water Conservation, Recovery & Storage Project (Cadiz Project). SB 307 seeks to impose a new, unique standard of state review upon the Cadiz Project. The bill proposes to further extend an exhaustive and comprehensive state

environmental review and approval process for the Cadiz Project by creating a new, duplicative and costly certification process even though state agencies have had the project under review for nearly a decade. SB 307 was signed by the Governor as Chapter 169, Statutes of 2019.

### **SB 413 (Rubio) San Gabriel Basin Water Quality Authority**

This bill extends by one year the terms of city representatives currently elected to the San Gabriel Basin Water Quality Authority (SGBWQA) Board and revises specified reporting requirements. SB 314 specifies that if a board member or alternate ceases to be a member of the governing body of the agency that has membership on the board, that board seat is deemed vacant, among other changes.

When a vacancy occurs under current law, SGBWQA must hold a special election to fill that seat at considerable time and cost to the authority and the cities that must nominate and elect a member to the board. Recent changes to California's local election laws have pushed more cities to hold elections in November of even years, with the potential result that someone will be elected to SGBWQA board, but soon thereafter have to vacate that seat because he or she didn't win reelection to the city council. SB 413 solves this problem with a one-time extension of current city representatives' terms by one year to get the timing right for SGBWQA board elections going forward. Future elections will take place in odd numbered years. It also updates the procedures for filling a vacancy to eliminate special elections in cases where a seat is only vacant for a short while. These are commonsense changes which the SGBWQA board unanimously approved following a public, transparent process. SB 413 also eliminates redundant reporting requirements with no loss of information to the public and regulators. By cutting down on the number of special elections and reducing the number of reports that must be prepared, SB 413 saves local governments' time and taxpayers' money. TVMWD strongly supported this bill. SB 413 was signed by the Governor as Chapter 370, Statutes of 2019.

### **SB 414 (Caballero) Small System Water Authority Act of 2019**

This bill establishes the Small System Water Authority Act of 2019, which both authorizes the creation of small system water authorities and requires consolidation of failing water systems.

The bill includes a framework for: (a) the formation of a small water system authority; (b) the internal organization of an authority and its board, officers, and employees; (c) requirements for how authority elections will be handled; (d) powers and purposes related to water, property, contracts and disputes; and (e) financial provisions that require the State Water Resources Control Board (SWRCB) to support specified costs. We supported the bill. SB 414 was held as a two-year bill in the Assembly Appropriations Committee.

### **SB 669 (Caballero) – Water Quality: Safe Drinking Water Fund**

This bill was another version of the Safe Drinking Water Fund. The bill was held in the Senate Appropriations Committee. We supported this version of the language. This bill created the Fund without a water tax. Key language from this bill was ultimately adopted as a part of the final bill SB 200 which was passed by the Legislature and enacted by the Governor.



## Board of Directors Staff Report

**To:** TVMWD Board of Directors  
**From:** Matthew H. Litchfield, General Manager   
**Date:** November 20, 2019  
**Subject:** JPIA Insurance Program Recognition

---

<input type="checkbox"/> For Action	<input type="checkbox"/> Fiscal Impact	\$
<input checked="" type="checkbox"/> Information Only	<input type="checkbox"/> Funds Budgeted	

---

**Staff Recommendation:**

**No Action Necessary – Informational Item Only**

**Discussion:**

Consistent with prior years, TVMWD is pleased to once again receive acknowledgement from ACWA/JPIA for low loss claims in each of the three programs that we participate in:

- Liability
- Property
- Workers Compensation

Attached is a formal letter from JPIA president Jerry Gladbach along with the ***President's Special Recognition Award*** certificates for each of the three programs.

**Strategic Plan Objective(s):**

2.3 – Manage water infrastructure and staff operations to minimize costs

3.3 – Be accountable and transparent with major decisions

**Attachment(s):**

Exhibit A – JPIA Memo and Insurance Recognition Certs

**Meeting History:**

None

KH/ML



**RECEIVED**

NOV 07 2019

**THREE VALLEYS MWD**



YOUR BEST PROTECTION

October 15, 2019

Three Valleys Municipal Water District (P006)  
1021 E. Miramar Avenue  
Claremont, CA 91711-2052

**ACWA JPIA**

P. O. Box 619082  
Roseville, CA 95661-9082

phone  
916.786.5742  
800.231.5742

direct line  
916.774.7050  
800.535.7899

fax  
916.774.7040

claims fax  
916.786.0209

[www.acwajpia.com](http://www.acwajpia.com)

**President**  
E.G. "Jerry" Gladbach

**Vice President**  
Tom Cuquet

**Chief Executive Officer**  
Walter "Andy" Sells

**Executive Committee**  
Fred Bockmiller  
Tom Cuquet  
David Drake  
E.G. "Jerry" Gladbach  
Brent Hastey  
Steven LaMar  
Melody A. McDonald  
J. Bruce Rupp  
Kathleen Tiegs

Matthew:

Each year at Fall Conference, the JPIA recognizes members that have a Loss Ratio of 20% or less in either of the Liability, Property, or Workers' Compensation programs (loss ratio = total losses / total premiums).

The members with this distinction receive the "**President's Special Recognition Award**" certificate for each Program that they qualify in.

The JPIA is extremely pleased to present Three Valleys Municipal Water District (P006) with this special recognition and commends the District on the hard work in reducing claims.

Congratulations to you, your staff, Board, and District. Keep up the good work!

The JPIA wishes you the best in 2020.

Sincerely,

E.G. "Jerry" Gladbach  
President

Enclosure: President's Special Recognition Award(s)

# President's Special Recognition Award

The President of the  
**ACWA JPIA**  
hereby gives Special Recognition to

## Three Valleys Municipal Water District

for achieving a low ratio of "Paid Claims and Case Reserves" to "Deposit Premiums"  
in the Liability Program for the period 10/01/2015 - 09/30/2018  
announced at the Board of Directors' Meeting in San Diego.



E. G. "Jerry" Gladbach, President



December 02, 2019

# *President's Special Recognition Award*

*The President of the  
ACWA JPIA  
hereby gives Special Recognition to*

## *Three Valleys Municipal Water District*

*for achieving a low ratio of "Paid Claims and Case Reserves" to "Deposit Premiums"  
in the Property Program for the period 04/01/2015 - 03/31/2018  
announced at the Board of Directors' Meeting in San Diego.*

*E. G. "Jerry" Gladbach*

*E. G. "Jerry" Gladbach, President*



*December 02, 2019*

# *President's Special Recognition Award*

*The President of the  
ACWA JPIA  
hereby gives Special Recognition to*

## *Three Valleys Municipal Water District*

*for achieving a low ratio of "Paid Claims and Case Reserves" to "Deposit Premiums"  
in the Workers' Compensation Program for the period 07/01/2015 - 06/30/2018  
announced at the Board of Directors' Meeting in San Diego.*



*E. G. "Jerry" Gladbach, President*



*December 02, 2019*